

Changes for the Better

MITSUBISHI CNC

Alarm/Parameter Manual
M700BM/M700UM Series



Introduction

This manual is the alarm/parameter guide required to use the MITSUBISHI CNC M700BM/M700UM Series. This manual is prepared on the assumption that your machine is provided with all of the MITSUBISHI CNC M700BM/M700UM Series functions. Confirm the functions available for your NC before proceeding to operation by referring to the specification issued by the machine tool builder.





Refer to the following manual for MITSUBISHI CNC M720 Alarms/Parameters.

MITSUBISHI CNC M720BM Alarm/Parameter Manual.....IB-1500038

Notes on Reading This Manual

- (1) This manual explains general parameters as viewed from the NC. For information about each machine tool, refer to manuals issued from the machine tool builder. If the descriptions relating to "restrictions" and "allowable conditions" conflict between this manual and the machine tool builder's instruction manual, the later has priority over the former.
- (2) This manual is intended to contain as much descriptions as possible even about special operations. The operations to which no reference is made in this manual should be considered impossible.
- (3) The "special display unit" explained in this manual is the display unit incorporated by the machine tool builder, and is not the MELDAS standard display unit.

CAUTION

-  **If the descriptions relating to "restrictions" and "allowable conditions" conflict between this manual and the machine tool builder's instruction manual, the later has priority over the former.**
-  **The operations to which no reference is made in this manual should be considered impossible.**
-  **This manual is compiled on the assumption that your machine is provided with all optional functions. Refer to the specifications issued by machine tool builder to confirm the functions available for your machine before proceeding to operation.**
-  **In some NC system versions, there may be cases that different pictures appear on the screen, the machine operates in a different way or some function is not activated.**

Refer to the following documents.

MDS-D2/DH2 Series Instruction Manual.....	IB-1501127
MDS-DM2 Series Instruction Manual.....	IB-1501139
MDS-DJ Series Instruction Manual.....	IB-1501133
MDS-D/DH Series Instruction Manual.....	IB-1500025
MDS-DM Series Instruction Manual.....	IB-1500893
MDS-D-SVJ3/SPJ3 Series Instruction Manual.....	IB-1500193

Precautions for Safety

Always read the specifications issued by the machine tool builder, this manual, related manuals and attached documents before installation, operation, programming, maintenance or inspection to ensure correct use.

Understand this numerical controller, safety items and cautions before using the unit.

This manual ranks the safety precautions into "DANGER", "WARNING" and "CAUTION".

DANGER

When the user may be subject to imminent fatalities or major injuries if handling is mistaken.

WARNING

When the user may be subject to fatalities or major injuries if handling is mistaken.

CAUTION

When the user may be subject to injuries or when physical damage may occur if handling is mistaken.

Note that even items ranked as " CAUTION", may lead to major results depending on the situation. In any case, important information that must always be observed is described.

For Safe Use

Mitsubishi CNC is designed and manufactured solely for applications to machine tools to be used for industrial purposes.

Do not use this product in any applications other than those specified above, especially those which are substantially influential on the public interest or which are expected to have significant influence on human lives or properties.

DANGER





Not applicable in this manual.

WARNING

Not applicable in this manual.

CAUTION

1. Items related to product and manual

-  If the descriptions relating to "restrictions" and "allowable conditions" conflict between this manual and the machine tool builder's instruction manual, the later has priority over the former.
-  The operations to which no reference is made in this manual should be considered impossible.
-  This manual is compiled on the assumption that your machine is provided with all optional functions. Refer to the specifications issued by machine tool builder to confirm the functions available for your machine before proceeding to operation.
-  In some NC system versions, there may be cases that different pictures appear on the screen, the machine operates in a different way or some function is not activated.

[Continued to next page]

 **CAUTION**

[Continued]

2. Items related to preparation before use

- ❗ If the battery low alarm is output, save the machining programs, tool data and parameters to an input/output device, and then replace the battery. If the BATTERY alarm occurs, the machining programs, tool data and parameters may be damaged. After replacing the battery, reload each data item.

3. Items related to maintenance

- ⚠ Do not replace the battery while the power is ON.
- ⚠ Do not short-circuit, charge, heat, incinerate or disassemble the battery.
- ⚠ Dispose of the spent battery according to local laws.

4. Items related to servo parameters and spindle parameters

- ⚠ Do not adjust or change the parameter settings greatly as operation could become unstable.
- ⚠ In the explanation on bits, set all bits not used, including blank bits, to "0".

Disposal



(Note) This symbol mark is for EU countries only.
This symbol mark is according to the directive 2006/66/EC Article 20 Information for end-users and Annex II.

Your MITSUBISHI ELECTRIC product is designed and manufactured with high quality materials and components which can be recycled and/or reused.

This symbol means that batteries and accumulators, at their end-of-life, should be disposed of separately from your household waste.

If a chemical symbol is printed beneath the symbol shown above, this chemical symbol means that the battery or accumulator contains a heavy metal at a certain concentration. This will be indicated as follows:

Hg: mercury (0,0005%), Cd: cadmium (0,002%), Pb: lead (0,004%)

In the European Union there are separate collection systems for used batteries and accumulators. Please, dispose of batteries and accumulators correctly at your local community waste collection/recycling centre.

Please, help us to conserve the environment we live in!

Trademarks

MELDAS, MELSEC, EZSocket, EZMotion, iQ Platform, MELSOFT, GOT, CC-Link, CC-Link/LT and CC-Link IE are either trademarks or registered trademarks of Mitsubishi Electric Corporation in Japan and/or other countries.

Ethernet is a registered trademark of Xerox Corporation in the United States and/or other countries.

Microsoft® and Windows® are either trademarks or registered trademarks of Microsoft Corporation in the United States and/or other countries.

CompactFlash and CF are either trademarks or registered trademarks of SanDisk Corporation in the United States and/or other countries.

UNIX is a registered trademark of The Open Group in the United States and/or other countries.

Intel®, Pentium® and Celeron® are either trademarks or registered trademarks of Intel Corporation in the United States and/or other countries.

Other company and product names that appear in this manual are trademarks or registered trademarks of the respective companies.

本製品の取扱いについて

(日本語/Japanese)

本製品は工業用(クラス A)電磁環境適合機器です。販売者あるいは使用者はこの点に注意し、住商業環境以外での使用をお願いいたします。

Handling of our product

(English)

This is a class A product. In a domestic environment this product may cause radio interference in which case the user may be required to take adequate measures.

본 제품의 취급에 대해서

(한국어/Korean)

이 기기는 업무용(A급) 전자파적합기기로서 판매자 또는 사용자는 이 점을 주의하시기 바라며 가정외의 지역에서 사용하는 것을 목적으로 합니다.

CONTENTS

1 Explanation of Alarms	1
1.1 Operation Errors (M)	2
1.2 Stop Codes (T).....	18
1.3 Servo/Spindle Alarms (S).....	25
1.3.1 Servo Errors (S01/S03/S04)	25
1.3.2 Initial Parameter Errors (S02)	40
1.3.3 Safety Function Errors (S05)	40
1.3.4 Parameter Errors (S51).....	41
1.3.5 Servo Warnings (S52).....	42
1.3.6 Safety Function Warnings (S53)	44
1.4 MCP Alarms (Y)	45
1.5 System Alarms (Z)	57
1.6 Absolute Position Detection System Alarms (Z7*)	65
1.7 Distance-coded Reference Scale Errors (Z8*).....	69
1.8 Emergency Stop Alarms (EMG).....	70
1.9 Computer Link Errors (L)	73
1.10 User PLC Alarms (U)	74
1.11 Network Service Errors (N)	77
1.12 Program Errors (P).....	79
2 Explanation of Parameters	113
2.1 Machining Parameters	114
2.2 I/O Parameters.....	136
2.3 Base Specifications Parameters	165
2.4 Axis Specifications Parameters	258
2.5 Servo Parameters	306
2.6 Spindle Parameters	341
2.7 Rotary Axis Configuration Parameters.....	423
2.8 Machine Error Compensation Parameters.....	430
2.9 PLC Constants.....	432
2.10 Macro List	436
2.11 PLC Axis Indexing Parameters	446
2.12 Position Switches.....	457
2.13 Screen Transition Chart	471
2.14 Unit.....	471
2.15 Setup Parameters	472
2.16 Machine Error Compensation (Function Details)	473
2.16.1 Function Outline.....	473
2.16.2 Setting Compensation Data.....	475
2.16.3 Example in Using a Linear Axis as the Base Axis	477
2.16.4 Example in Using a Rotary Axis as the Base Axis.....	481
2.17 Position Switch (Function Details)	482
2.17.1 Function Outline.....	482
2.17.2 Canceling the Position Switch.....	484
2.18 Table: "Contents of bit selection parameters #6449 to #6496"	485
3 Appendix	487
3.1 7-segment LED Alarm/Status Display Function	488
3.1.1 Display of Status	488
3.1.2 Display of Alarm.....	488
3.1.3 Precautions	489
3.1.4 Example of Alarm Display.....	490



Explanation of Alarms

1.1 Operation Errors (M)

(Note) "M01" alarms are displayed as "M01 Operation error" with the error number. Error number is four digit number displayed after error name (such as 0001). "M01" alarms are listed in ascending order in this manual.

M01 Dog overrun 0001

Details

When returning to the reference position, the near-point detection limit switch did not stop over the dog, but overran the dog.

Remedy

- Increase the length of the near-point dog.
- Reduce the reference position return speed.

M01 Some ax does not pass Z phase 0002

Details

One of the axes did not pass the Z-phase during the initial reference position return after the power was turned ON.

Remedy

- Move the detector one rotation or more in the opposite direction of the reference position, and repeat reference position return.

M01 R-pnt direction illegal 0003

Details

When manually returning to the reference position, the return direction differs from the axis movement direction selected with the AXIS SELECTION key.

Remedy

- The selection of the AXIS SELECTION key's +/- direction is incorrect. The error is canceled by feeding the axis in the correct direction.

M01 External interlock axis exists 0004

Details

The external interlock function has activated (the input signal is "OFF") and one of the axes has entered the interlock state.

Remedy

- As the interlock function has activated, release it before resuming operation.
- Correct the sequence on the machine side.
- Check for any broken wires in the "interlock" signal line.

M01 Internal interlock axis exists 0005

Details

The internal interlock state has been entered.
 The absolute position detector axis has been removed.
 A command for the manual/automatic simultaneous valid axis was issued from the automatic mode.
 The manual speed command was issued while the "tool length measurement 1" signal is ON.
 A travel command has been issued to an inclined axis whose base axis is in control axis synchronization across part systems.

Remedy

- The servo OFF function is valid, so release it first.
- An axis that can be removed has been issued, so perform the correct operations.
- The command is issued in the same direction as the direction where manual skip turned ON, so perform the correct operations.
- During the manual/automatic simultaneous mode, the axis commanded in the automatic mode became the manual operation axis. Turn OFF the "manual/automatic valid" signal for the commanded axis.
- Turn ON the power again, and perform absolute position initialization.
- Turn OFF the "tool length measurement 1" signal to start the program by the manual speed command.
- Cancel the control axis synchronization across part systems, then issue a travel command to the inclined axis.

M01 H/W stroke end axis exists 0006**Details**

The stroke end function has activated (the input signal is "OFF") and one of the axes is in the stroke end status.

Remedy

- Move the machine manually.
- Check for any broken wires in the "stroke end" signal line.
- Check for any limit switch failure.

M01 S/W stroke end axis exists 0007**Details**

The stored stroke limit I, II, IIB or IB function has activated.

Remedy

- Move the machine manually.
- Correct any setting error of the parameters for the stored stroke limit.

M01 Chuck/tailstock stroke end ax 0008**Details**

The chuck/tail-stock barrier function turned ON, and an axis entered the stroke end state.

Remedy

- Reset the alarm with reset, and move the machine in the reverse direction.

M01 Ref point return No. invalid 0009**Details**

2nd reference position return was performed before 1st reference position return has been completed.

Remedy

- Execute 1st reference position return.

M01 Sensor signal illegal ON 0019**Details**

The sensor signal was already ON when the "tool length measurement 2(TLMS)" signal was validated. The sensor signal turned ON when there was no axis movement after the "tool length measurement 2(TLMS)" signal was validated.

The sensor signal turned ON at a position within 100 μ m from the final entry start position.

Remedy

- Disable the "tool length measurement 2(TLMS)" signal and move the axis in a safe direction.
- Disabling the sensor signal also clears the operation alarm.

(Note) When the "tool length measurement 1" signal is disabled, the axis can be moved in either direction. Pay attention to the movement direction.

M01 Ref point retract invalid 0020**Details**

Reference position retract was performed while the coordinates had not been established.

Remedy

- Execute reference position return.

M01 Tool ofs invld after R-pnt 0021**Details**

Reference position return mode was selected in the tool retract and return.

Remedy

Reference position return can be executed. Yet be aware of the followings;

- The amount of the tool compensation will be invalid after the reference position return.
- In the block after the halt point block, tool path will be shifted by the tool compensation amount.

M01 R-pnt ret invld at zero pt ini 0023**Details**

The reference position return mode was selected during the escape and retract mode.

Remedy

- Do not select the reference position return mode during the escape and retract mode.

M01 R-pnt ret invld at abs pos alm 0024

Details

A reference position return signal was enabled during an absolute position detection alarm.

Remedy

- Reset the absolute position detection alarm, and then perform the reference position return.

M01 R-pnt ret invld at zero pt ini 0025

Details

A reference position return signal was input during zero point initialization of the absolute position detection system.

Remedy

- Complete the zero point initialization, and then perform reference position return.

M01 High-accuracy skip disabled 0028

Details

The drive unit's hardware or software does not conform to the high-accuracy skip.

Remedy

- The software or hardware does not conform to the function. Contact service center.

M01 Hi-ac skip coord retrieval err 0029

Details

Failed to retrieve the skip coordinate value from the drive unit.

Remedy

- Check the wiring.
- Check the parameters.

M01 Now skip on 0030

Details

The "skip input" signal remains enabled when the operation has shifted from skip retract to measurement.

Remedy

- Increase the skip retract amount.

M01 No skip 0031

Details

Even though the 1st skip was to the correct position, the 2nd skip could not be found.

Remedy

- Check whether the measurement target has moved.

M01 Rtn dir err in manual measure 0033

Details

Return direction in manual measurement is the opposite of the parameter setting.

Remedy

- Check and correct the "#2169 Man meas rtn dir (Return direction in manual measurement)" setting.
- Move the axis manually to a safe position in the direction set by "#2169 Man meas rtn dir (Return direction in manual measurement)", then reset.

M01 Multi axes for tool escape 0034

Details

A spindle selection signal for 2 or more spindles is selected at the same time.

Remedy

- Select a spindle selection signal for an axis.

M01 Movement prohibited during tool retract 0035**Details**

An axis movement was attempted from the tool retract position.
The movement was attempted by a manual command in the tool return.
Under the tool retract and return 2 and during the repositioning, an axis was transferring by a manual command.

Remedy

Tool retract and return
It is not allowed to move an axis arbitrarily from the tool retract position. The interruption by a manual command is not allowed during the tool return. Take the following steps to move an axis as necessary.

- Cancel the program execution by reset.
- Use the tool escape and retract function and let the axis escape from the tool retract position.

Tool retract and return 2

Any interruption by a manual command is not allowed during the tool return. (However, re-retract by a manual command is allowed when the single block is stop at the transit point.)

Any interruption by a manual command is not allowed after the feed hold during repositioning. Take the following step to move an axis as necessary.

- Cancel the program execution by reset.

M01 OP mode changed during return 0037**Details**

The return was operated in a different mode from the operation mode at the retract.
The operation mode was changed during returning.

Remedy

- Change the operation mode into the mode at the retract, and turn the signal on to start the return.

M01 Chopping axis R-pnt incomplete 0050**Details**

Chopping mode has been entered while the chopping axis has not completed reference position return.
All axes interlock has been applied.

Remedy

- Reset the NC or disable the "chopping" signal, and then carry out the reference position return.

M01 Synchronous error excessive 0051**Details**

The synchronization error of the primary and secondary axes exceeded the allowable value under synchronous control. A deviation exceeding the synchronization error limit value was found with the synchronization deviation detection.

Remedy

- Select the correction mode and move one of the axes in the direction in which the errors are reduced.
- Increase "#2024 synerr(allowable value)" or set "0" to disable error check.
- When using simple C-axis synchronous control, set "0" for "synchronous control operation method".

M01 No spindle select signal 0053**Details**

Synchronous tapping command was issued when the "spindle selection" signals for all spindles were OFF in the multiple-spindle control II.

Remedy

- Turn ON the "spindle selection" signal for the tapping spindle before performing the synchronous tapping command.

M01 No spindle serial connection 0054**Details**

Synchronous tapping command was issued in the multiple-spindle control II, while the spindle with the "spindle selection" signal ON was not serially connected.

Remedy

- Make sure the "spindle selection" signal for the spindle is ON.
- Consider the machine construction when issuing the command.

M01 Spindle fwd/rvs run para err 0055

Details

Asynchronous tapping command was issued when M code of the spindle forward/reverse run command, set by "#3028 sprcmm", was one of the followings in the multiple-spindle control II.

- M0, M1, M2, M30, M98, M99, or M198
- M code No. that commands to enable/disable the "macro interrupt" signal

Remedy

- Correct the "#3028 sprcmm (Tap cycle spindle forward run/reverse run M command)" setting.

M01 Tap pitch/thread number error 0056

Details

The command for the pitch or the number of threads is not correct in the synchronous tapping command of the multiple-spindle control II.

- The pitch is too small for the spindle rotation speed.
- Thread number is too large for the spindle rotation speed.

Remedy

- Correct the pitch, number of threads or rotation speed of the tapping spindle.

M01 Wait for tap retract 0057

Details

The axis travel command is interlocked in the part system where the "Tap retract possible" signal is ON.

Remedy

- If tap retract is necessary, perform it before issuing an axis travel command. However, tapping retract is not allowed during automatic operation. Carry out tapping retract after resetting.
- If tap retract is not necessary, cancel the tap retract enabled state.

M01 Excessive handle feed rate 0060

Details

The handle feed travel amount by one scale exceeds the travel amount at the clamp speed within a certain time.

Remedy

- Correct the handle feed magnification.

M01 R-pos offset value illegal 0065

Details

At the start of reference position initial setting, "#2034 rpfpos (Distance-coded reference position detection offset) is not set to "0".

Remedy

- Set "#2034 rpfpos" to "0", then turn the power ON again to perform the reference position initial setting.

M01 R-pos scan distance exceeded 0066

Details

Reference position could not be established within the maximum scan distance.

Remedy

- Check the scale to see if it has dirt or damage.
- Check if the servo drive unit supports this function.

M01 Illegal op in wk instl err cmp 0070

Details

One of the following operations was attempted during workpiece installation error compensation.

- Manual interruption
- Automatic operation handle interruption
- MDI interruption
- PLC interruption

Remedy

- Return the operation mode to the original mode to remove the cause.

M01 No operation mode 0101**Details**

No operation mode

Remedy

- Check for any broken wires in the input mode signal line.
- Check for any failure of the MODE SELECT switch.
- Correct the sequence program.

M01 Cutting override zero 0102**Details**

The "cutting feed override" switch on the machine operation panel is set to "0".
The override was set to "0" during a single block stop.

Remedy

- Set the "cutting feed override" switch to a value other than "0" to clear the error.
- If the "cutting feed override" switch has been set to a value other than "0", check for any short circuit in the signal line.
- Correct the sequence program.

M01 External feed rate zero 0103**Details**

MANUAL FEEDRATE switch on the machine operation panel is set to "0" when the machine is in the JOG or automatic dry run mode.

"Manual feedrate B" is set to "0" during the JOG mode when manual feedrate B is valid.

"Each axis manual feedrate B" is set to "0" during the JOG mode when each axis manual feedrate B is valid.

Remedy

- Set the MANUAL FEEDRATE switch to a value other than "0" to release the error.
- If the MANUAL FEEDRATE switch has been set to a value other than "0" check for any short circuit in the signal line.
- Correct the sequence program.

M01 F 1-digit feed rate zero 0104**Details**

The F1-digit feedrate has been set to "0" when the F1-digit feed command was executed.

Remedy

- Set the F1-digit feedrate (from "#1185 spd_F1 (F1 digit feedrate F1)" to "#1189 spd_F5 (F1 digit feedrate F5)").

M01 Spindle stop 0105**Details**

The spindle stopped during the synchronous feed/thread cutting command.

Remedy

- Rotate the spindle.
- If the workpiece is not being cut, start dry run.
- Check for any broken wire in the spindle encoder cable.
- Check the connections for the spindle encoder connectors.
- Check the spindle encoder pulse.
- Correct the program. (commands and addresses)

M01 Handle feed ax No. illegal 0106**Details**

The axis, designated at handle feed, is out of specifications.

No axis has been selected for handle feed.

Remedy

- Check for any broken wires in the handle feed axis selection signal line.
- Correct the sequence program.
- Check the number of axes in the specifications.

M01 Spindle rotation speed over 0107**Details**

Spindle rotation speed exceeded the axis clamp speed during the thread cutting command.

Remedy

- Lower the commanded rotation speed.

M01 Fixed pnt mode feed ax illegal 0108**Details**

The axis, designated in the manual arbitrary feed, is out of specifications.
The feedrate in manual arbitrary feed mode is illegal.

Remedy

- Check for any broken wires in the axis selection signal line or the feedrate line for the manual arbitrary feed mode.
- Check the specifications for the manual arbitrary feed mode.

M01 Block start interlock 0109**Details**

An interlock signal has been input to lock the block start.

Remedy

- Correct the sequence program.

M01 Cutting block start interlock 0110**Details**

An interlock signal has been input to lock the cutting block start.

Remedy

- Correct the sequence program.

M01 Restart switch ON 0111**Details**

Restart switch has been turned ON and manual mode has been selected before the restart search is completed.

Remedy

- Search the block to restart.
- Turn the restart switch OFF.

M01 Program check mode 0112**Details**

The automatic start button was pressed during program check or in program check mode.

Remedy

- Press the reset button to cancel the program check mode.

M01 Auto start in buffer correct 0113**Details**

The automatic start button was pressed during buffer correction.

Remedy

- Press the automatic start button after the buffer correction is completed.

M01 In reset process 0115**Details**

The automatic start button was pressed during resetting or tape rewinding.

Remedy

- When rewinding the tape, wait for the winding to end, or press the reset button to stop the winding, and then press the automatic start button.
- During resetting, wait for the resetting to end, and then press the automatic start button.

M01 Playback not possible 0117**Details**

The playback switch was turned ON during editing.

Remedy

- Cancel the editing by pressing the input or previous screen key before turning ON the playback switch.

M01 Turn stop in normal line cntrl 0118**Details**

The turning angle at the block joint exceeded the limit during normal line control.

In normal line control type I:

"#1523 C_feed (Normal line control axis turning speed)" has not been set.

In normal line control type II:

When turning in the inside of the arc, the set value for "#8041 C-rot. R" is larger than the arc radius.

Remedy

- Correct the program.
- Correct the "#1523 C_feed (Normal line control axis turning speed)" setting.
- Correct the "#8041 C rot. R" setting.

M01 Reverse run impossible 0119**Details**

Either of the following conditions occurred:

- there is no block to run backward.
- eight blocks has been continued without any travel command.

Remedy

- Execute forward run to clear the alarm.
- Reset to clear the alarm.

M01 In synchronous correction mode 0120**Details**

The synchronous correction mode switch was pressed in non-handle mode.

Remedy

- Select the handle or manual arbitrary feed mode.
- Turn OFF the correction mode switch.

M01 No synchronous control option 0121**Details**

The synchronous control operation method was set (with R2589) while no synchronous control option was provided.

Remedy

- Set "0" for "synchronous control operation method".

M01 Computer link B not possible 0123**Details**

Cycle start was attempted before resetting was completed.

Computer link B operation was attempted at the 2nd or further part system in a multi-part system.

Remedy

- Perform the cycle start after resetting has been completed.
- Set "#8109 HOST LINK" to "0" and then set to "1" before performing the cycle start.
- Computer link B operation cannot be performed at the 2nd or further part system in a multi-part system.

M01 X/Z axes simultaneous prohibit 0124**Details**

The basic axis corresponding to the inclined axis was started simultaneously in the manual mode while the inclined axis control was valid.

Remedy

- Turn the inclined axis and basic axis start OFF for both axes. (This is also applied for manual/automatic simultaneous start.)
- Disable the basic axis compensation, or command it to axes one by one.

M01 Rapid override zero 0125

Details

The RAPID TRAVERSE OVERRIDE switch on the machine operation panel is set to "0".

Remedy

- Set the RAPID TRAVERSE OVERRIDE switch to a value other than "0" to clear the error.
- If the RAPID TRAVERSE OVERRIDE switch has been set to a value other than "0", check for any short circuit in the signal line.
- Correct the sequence program.

M01 Program restart machine lock 0126

Details

Machine lock was applied on the return axis being manually returned to the restart position.

Remedy

- Cancel the machine lock and resume the operation.

M01 Rot axis parameter error 0127

Details

Orthogonal coordinate axis name does not exist.

Rotary axis name does not exist.

A duplicate name is used for the designated orthogonal coordinate axis.

The number of axes that were selected to change tool length compensation along the tool axis amount exceeds the maximum number of axes.

The designated orthogonal coordinate axis name is the same as the rotary axis name.

Remedy

- Correct the rotary axis configuration parameters.

M01 Restart pos return incomplete 0128

Details

Automatic return was performed with an axis whose return to the restart position was not complete.

Remedy

- Perform restart position return manually.
- Enable "#1302 AutoRP (Automatic return by program restart)" before executing the automatic start.

M01 PLC interruption impossible 0129

Details

After the automatic startup, the "PLC interrupt" signal was turned ON during buffer correction, program restart, arbitrary reverse run, tool retract and return, high-speed high-accuracy control II, or NURBS interpolation.

Remedy

- By turning OFF the "PLC interrupt" signal, or by resetting the NC the error can be cancelled.

M01 Restart posn return disabled 0130

Details

Restart position return was attempted in a mode where the return is disabled.

Remedy

- Correct the program restart position.

M01 Zero point return interruption 0131

Details

Compound type fixed cycle program was interrupted with manual zero point return, and cycle start was carried out without carrying out reset.

Remedy

- Cancel the program execution by reset.

M01 Manual 3D coord conv ON 0140**Details**

An axis is started with following operations while 3D coordinate conversion manual feed is enabled.

- Manual reference position return
- Tool retract and return
- Manual tool length measurement
- Workpiece position measurement
- Manual skip

Remedy

- Turn OFF the signal to switch the 3D coordinate conversion:manual feed.

M01 Man 3D coor conv: Multi ax ON 0141**Details**

Two or more of basic three axes are simultaneously started as the 3D coordinates conversion manual feed.

Remedy

- Disable the manual 3D coordinate conversion, or start the axes one by one.

M01 Chopping override zero 0150**Details**

The override became "0" in the chopping operation.

Remedy

- Correct the setting of "chopping override" (R2503).
- Correct the setting of "rapid traverse override" (R2502).

M01 Command axis chopping axis 0151**Details**

A chopping axis movement command was issued from the program during the chopping mode. (This alarm will not occur for the command with the movement amount "0".)

Remedy

- Press the reset button.

M01 Bottom dead center pos. zero 0153**Details**

The bottom dead center position is set to the same position as the upper dead center position.

Remedy

- Correct the bottom dead center position.

M01 Chopping disable for handle ax 0154**Details**

Chopping has been attempted while the chopping axis is selected as the handle axis.

Remedy

- Select an axis other than the chopping axis as the handle axis, or start chopping after changing the mode to the other mode.

M01 No speed set out of soft limit 0160**Details**

The axis, without any maximum speed outside of the soft limit range set, was returned from the outside of the soft limit range.

Remedy

- Correct the "#2021 out_f (Maximum speed outside soft limit range)" setting.
- Correct the soft limit range (with "#2013 OT- (Soft limit I-)" and "#2014 OT+ (Soft limit I+)").

M01 Ill. op during T tip control 0170**Details**

Illegal operation was attempted during tool tip center control.

Remedy

- Change the operation mode to the previous one and restart.

M01 Illegal OP in tilted face cut 0185

Details

Any of the following illegal operations was attempted during inclined surface machining mode.

- Manual interrupt
- Handle interrupt in automatic operation
- MDI interrupt
- PLC interrupt
- Arbitrary reverse run

Remedy

- Switch the operation mode back to the previous to remove the cause of this failure.

M01 Mach. interference axis exists 0203

Details

3D machine interference check detected an interfering axis and stop the operation.

(Note) This alarm appears when #1594 3DStpSel is 0.

Remedy

- Refer to the manual of your machine builder.

M01 Mach. interfere interlock axis 0204

Details

3D machine interference check detected an interfering axis and the axis has entered the interlock state.

(Note) This alarm appears when #1594 3DStpSel is 1.

Remedy

- Refer to the manual of your machine builder.

M01 Manual feed for 5-axis machining/Simultaneous command to multiple axes 0230

Details

More than one axis was designated simultaneously in manual mode while the manual feed for 5-axis machining was valid.

Remedy

- Command the manual feed to each axis one by one.

M01 Manual feed for 5-axis machining/Selecting coordinate system illegal 0231

Details

- More than one of the three bits for selecting hypothetical coordinate system was turned ON.
- Hypothetical coordinate system was selected while the manual feed for 5-axis machining was invalidated by the parameter setting.

Remedy

- Check the sequence program.
- Validate the manual feed for 5-axis machining (parameter "#7912 NO_MANUAL").

M01 Illegal op in 5 ax tool R comp 0232

Details

An illegal operation (such as manual interrupt) was attempted during tool radius compensation for 5-axis machining.

Remedy

- Operations such as manual interrupt are disabled while the tool radius compensation for 5-axis machining is being performed.

M01 Machining surface operation disabled 0250**Details**

Machining surface operation (selection, indexing or cancel) was attempted while the operation is disabled.

Remedy

- Cancel the other modes so that the inclined surface machining command (G68.2), tool axis direction control (G53.1) and the inclined surface machining cancel command (G69) can be issued.
- Wait until the axes stop completely (until the smoothing for all axes reaches zero).
- Perform operation search for machining programs.

M01 Illegal movement command during superimposition 1003**Details**

- A machine command was issued to the superimposing axis.
- Reference position return was attempted on the superimposing axis.
- Skip command was issued to the master or superimposing axis.
- Dog-type reference position return was attempted on the master axis.

Remedy

- Correct the program.

M01 Superimposition command illegal 1004**Details**

- Superimposition command (G126) was issued to the axis which is executing the following functions.
Synchronization control
Milling interpolation
- Superimposition start command was issued to the axis which was under superimposition control.

Remedy

- Correct the program.

M01 G114.n command illegal 1005**Details**

G114.n has been commanded during the execution of G114.n.
G51.2 has been commanded when G51.2 spindle-spindle polygon machining mode has been already entered at another part system.

Remedy

- Command G113 to cancel the operation.
- Turn ON the "spindle synchronization cancel" signal to cancel the operation.
- Command G50.2 to cancel the operation.
- Turn ON the "spindle-spindle polygon cancel" signal to cancel the operation.

M01 Spindle in-use by synchro tap 1007**Details**

The spindle is being used in synchronized tapping.

Remedy

- Cancel the synchronized tapping.

M01 SP-C ax ctrl runs independntly 1026**Details**

C axis mode command has been issued for polygon machining spindle.
C axis mode command has been issued for synchronized tapping spindle.
Polygon command has been issued for synchronized tapping spindle.
Spindle is being used as spindle/C axis.

Remedy

- Cancel the C axis command.
- Cancel the polygon machining command.
- Cancel the C axis with servo OFF.

M01 Variable feed thread cutting invalid 1029**Details**

- Thread cutting has been commanded by setting "1" to "#8045" while variable feed thread cutting option is invalid.
- Variable feed thread cutting has been commanded while soft acceleration/deceleration is applied for the feed axis.
- Variable feed thread cutting has been commanded while spindle encoder input is not serially connected.
- Variable feed thread cutting has been commanded while NON MDS-D series is employed for the spindle, lead axis or the axes forming the selected plane.

Remedy

- Correct the program and parameter settings.

M01 Synchronization mismatch 1030**Details**

Different M codes were each commanded as synchronization M code in each of the two part systems. Synchronization with the "!" code was commanded in another part system during M code synchronization.
Synchronization with the M code was commanded in another part system during synchronization with the "!" code.

Remedy

- Correct the program so that the M codes match.
- Correct the program so that the same synchronization codes are commanded.

M01 Multiple C axes select invalid 1031**Details**

The "C axis selection" signal has been changed when the multiple C axes selection is not available. The selected axis by the "C axis selection" signal cannot be controlled for the multiple C axes selection.

Remedy

- Correct the parameter settings and program.

M01 Tap retract Sp select illegal 1032**Details**

Tap retract has been executed with a different spindle selected. Cutting feed is in wait state until synchronization is completed.

Remedy

- Select the spindle for which tap cycle was halted before turning ON the "tap retract" signal.

M01 Sp-Sp polygon cut interlock 1033**Details**

Cutting feed is in wait state until synchronization is completed.

Remedy

- Wait for the synchronization to end.

M01 Mixed sync ctrl prmtr illegal 1034**Details**

There is a mistake in the settings of mixed control axis parameters (crsax [1] to [8]). Mixed control was attempted within one and the same part system. Any of the parameter settings is disabling mixed control.

Remedy

- Correct the parameter settings for the mixed control (cross axis control).

M01 Mixed sync ctrl disable modal 1035**Details**

Mixed control (cross axis control) was commanded for a part system in which the mixed control (cross axis control) is disabled as shown below.

- During nose R compensation mode
- During pole coordinate interpolation mode
- During cylindrical interpolation mode
- During balance cut mode
- During fixed cycle machining mode
- During facing turret mirror image
- During constant surface speed control mode
- During hobbing mode
- During axis name switch

An axis was transferred to another part system, and mixed control was attempted with the part system's maximum number of control axes exceeded.

An axis was removed from the part system, and mixed control was attempted with the part system's number of axes zero.

Another axis exchange was attempted to the axis which was already transferred to another part system for mixed control.

Remedy

- Correct the program.

M01 Synchro ctrl setting disable 1036**Details**

"Synchronous control operation method" was set (with R2589) when the mode was not the C axis mode.

"Synchronous control operation method" was set (with R2589) in the zero point not set state.

Mirror image is disabled.

External mirror image or parameter mirror image was commanded during facing turret mirror image.

Remedy

- Set the contents of the R2589 register to "0".
- Correct the program and parameters.

M01 Synchro start/cancel disable 1037**Details**

Synchronous control start/cancel command was issued when the start/cancel is disabled.

Remedy

- Correct the program and parameters.

M01 Move cmdnd invld to synchro ax 1038**Details**

A travel command was issued to a synchronous axis in synchronous control.

Remedy

- Correct the program.

M01 External spindle speed clamp speed zero 1039**Details**

External spindle speed clamp signal has been turned ON while the clamp speed has not been set.

Remedy

- Set the external spindle speed clamp feedrate parameter.
- Turn OFF the external spindle speed clamp signal.

M01 Optimum acceleration/deceleration selection tuning disabled 1040**Details**

- Parameter changeover has been requested while the axis is in motion.

- Inertia instruction has been executed during C-axis control/ spindle synchronization/ orientation.

Remedy

- Stop the axes in the part system, as well as the spindle.
- Execute the instruction in spindle mode. (The mode will be canceled by reset.)

M01 No spindle speed clamp 1043

Details

The constant surface speed command (G96) was issued to the spindle which is not selected for the spindle speed clamp command (G92/G50) under Multiple spindle control II.

Remedy

Press the reset key and carry out the remedy below.
 - Select the spindle before commanding G92/G50.

M01 Sp synchro phase calc illegal 1106

Details

Spindle synchronization phase alignment command was issued while the "phase shift calculation request" signal was ON.

Remedy

- Correct the program.
 - Correct the sequence program.

M80 POSITION ERROR

Details

An axis position is illegal.
 An alarm is displayed (AL4 is output) and a block stop is applied on the machining program.
 When the block stop is not allowed in the thread cutting cycle and the like, the stop is applied at the next position where allowed.

Remedy

Carry out reset. Then confirm that the system starts the operation. If the alarm is displayed again, turn ON the emergency stop switch and turn the NC power OFF and ON.

M90 Parameter set mode

Details

The lock for setup parameters has been released. Setting the setup parameters is enabled while automatic start is disabled.

Remedy

Refer to the manual issued by the machine tool builder.

M91 INVALID MEASUR. 0002

Details

Data is over the range
 The measurement result exceeds the tool data setting range.

Remedy

Correct the settings of "#2015 tlmI- (Negative direction sensor of tool setter)" and "#2016 tlmI+ (Positive direction sensor of tool setter or TLM standard length)".

M91 INVALID MEASUR. 0003

Details

No corresponding No.
 No measurement tool No. has been set.
 The registered No. is out of the specifications.

Remedy

Correct the measurement tool No.

M91 INVALID MEASUR. 0045

Details

Measurement axis illegal
 Sensor has been turned ON while two or more axes are moving.

Remedy

Move a single axis when the sensor is contacted.

M91 INVALID MEASUR. 0046**Details**

Measurement axis has not returned to reference position
Reference position return has not been executed on a measurement axis in an incremental system.

Remedy

Carry out the reference position return on the measurement axis before measuring the tool.

M91 INVALID MEASUR. 0089**Details**

Sensor signal illegal ON
Sensor has already been ON when TLM mode is turned ON. The travel amount was so small that the tool contacted the sensor.

Remedy

All axes are interlocked when this alarm has occurred.
Turn the TLM mode OFF or use the interlock cancel signal to move the tool off the sensor.
Ensure at least 0.1mm for the movement to the sensor.

M91 INVALID MEASUR. 9000**Details**

Speed at contact is below minimum
The tool has contacted the sensor at the lower speed than set in "#1508 TLM_Fmin (Minimum speed toward tool setter)".

Remedy

Correct the feed rate to move the tool to the sensor.

M91 INVALID MEASUR. 9001**Details**

Speed at contact is over maximum
The tool has contacted the sensor at the higher speed than set in "#1509 TLM_Fmax (Maximum speed toward tool setter)".

Remedy

Correct the feed rate to move the tool to the sensor.

M91 INVALID MEASUR. 9002**Details**

Change of compensation No. or sub-side selection during measurement
A compensation No. or sub-side valid signal state has been changed while a sensor signal is ON or a compensation amount is being written.

Remedy

Carry out the measurement again.

M91 INVALID MEASUR. 9003**Details**

Error on response timing of sensor signal
A compensation No. has been changed at the same time as a sensor's response.

Remedy

Carry out the measurement again.

M92 IGNORE INT.LOCK**Details**

Manual tool length measurement Interlock temporarily canceled
"M01 Operation error 0005" and "M01 Operation error 0019", which occur at manual tool length measurement, are temporarily canceled. When a tool has contacted a sensor and "M01 Operation error 0019" has occurred, tool escape is enabled by temporarily turning ON the interlock cancel request. This alarm notifies that the interlock is disabled in the meantime.

Remedy

After carrying out the tool escape from the sensor, turn OFF the interlock temporary cancel signal for manual tool length measurement.

1.2 Stop Codes (T)

T01 Cycle start prohibit

Automatic start is not available in stop state.

T02 Feed hold

Feed hold is actuated during automatic operation for some reason.

T03 Block stop

Block stop is actuated during automatic operation for some reason.

(Note 1) "T01" stop codes are displayed as "T01 Cycle start prohibit" with the error number. Error number is four digit number displayed after error name (start from 0101). "T01" stop codes are listed in ascending order in this manual.

(Note 2) "T02" stop codes are displayed as "T02 Feed hold" with the error number. Error number is four digit number displayed after error name (start from 0201). "T02" stop codes are listed in ascending order in this manual.

(Note 3) "T03" stop codes are displayed as "T03 Block stop" with the error number. Error number is four digit number displayed after error name (start from 0301). "T03" stop codes are listed in ascending order in this manual.

T01 Axis in motion 0101

Details

Automatic start is not possible as one of the axes is moving.

Remedy

- Try automatic start again after all axes have stopped.

T01 NC not ready 0102

Details

Automatic start is not possible as the NC is not ready.

Remedy

- Another alarm has occurred. Check the details and remedy.

T01 Reset signal ON 0103

Details

Automatic start is not possible as the "reset" signal has been input.

Remedy

- Turn OFF the "reset" signal.
- Check for any failure of the reset switch which has caused the switch's continuous ON.
- Correct the sequence program.

T01 Auto operation pause signal ON 0104

Details

The feed hold switch on the machine operation panel is ON (valid).

Remedy

- Correct the feed hold switch setting.
- The feed hold switch is B contact switch.
- Fix any broken wires in the feed hold signal line.
- Correct the sequence program.

T01 H/W stroke end axis exists 0105

Details

Automatic start is not possible as one of the axes is at the stroke end.

Remedy

- Manually move any axis whose end is at the stroke end.
- Check for any broken wires in the stroke end signal line.
- Check for any failure in the stroke end limit switch.

T01 S/W stroke end axis exists 0106

Details

Automatic start is not possible as one of the axes is at the stored stroke limit.

Remedy

- Move the axis manually.
- If the axis's end is not at the stroke end, check the parameters.

T01 No operation mode 0107**Details**

The operation mode has not been selected.

Remedy

- Select automatic operation mode.
- Check for any broken wires in the signal line for automatic operation mode (memory, tape, MDI).

T01 Operation mode duplicated 0108**Details**

Two or more automatic operation modes have been selected.

Remedy

- Check for any short circuit in the mode (memory, tape, MDI) selection signal line.
- Check for any failure in the switch.
- Correct the sequence program.

T01 Operation mode changed 0109**Details**

The automatic operation mode has changed to another automatic operation mode.

Remedy

- Return to the original automatic operation mode, and execute automatic start.

T01 Tape search execution 0110**Details**

Automatic start is not possible as tape search is being executed.

Remedy

- Wait for the tape search to be completed and then execute the automatic start.

T01 Cycle start prohibit 0111**Details**

Automatic start is disabled because restart search is in execution.

Remedy

- Execute automatic start after the restart search is completed.

T01 Restart pos. return incomplete 0112**Details**

Automatic start is not possible as the axis has not been returned to the restart position.

Remedy

- Manually return the axis to the restart position.
- Turn ON the automatic restart valid parameter, and then execute the automatic start.

T01 CNC overheat 0113**Details**

Automatic start is not possible because a thermal alarm (Z53 CNC overheat) has occurred.

Remedy

- Temperature of the control unit has exceeded the specified temperature.
- Take appropriate measures to cool the unit.

T01 Cycle st. prohibit(Host comm.) 0115**Details**

Automatic start cannot is not possible because the NC is communicating with the host computer.

Remedy

- Wait for the communication with host computer to be ended and then execute the automatic start.

T01 Cycle st prohibit(Battery alm) 0116

Details

Automatic start is not possible because the voltage of the battery in the NC control unit has dropped.

Remedy

- Replace the battery of the NC control unit.
- Contact the service center.

T01 R-pnt offset value not set 0117

Details

Automatic operation is not possible because no reference position offset value has been set.

Remedy

- Perform the reference position initialization setting, then set "#2034 rfpofs(Distance-coded reference position detection offset)".

T01 Cycle start prohibit 0118

Details

Tool retract position signal OFF

The axis was moved from the tool retract position. Tool retract position reached signal is OFF.

Remedy

Once the axis has been moved off the tool retract position, resuming the program is not possible. Cancel the program by reset and then execute it from the start.

T01 User PLC address conflict alm 0119

Details

The automatic start is not possible because the User PLC address conflict alarm occurs.

Remedy

- Cancel the user PLC address conflict alarm.

T01 In absolute position alarm 0138

Details

A start signal was input during an absolute position detection alarm.

Remedy

- Clear the absolute position detection alarm, and then input the start signal.

T01 In abs posn initial setting 0139

Details

A start signal was input during zero point initialization in the absolute position detection system.

Remedy

- Complete zero point initialization before inputting the start signal.

T01 Start during MDI operation at other part system disable 0141

Details

In multi-part system, a start signal was input for MDI mode while the MDI operation was being carried out in another part system.

Remedy

- End the other part system's operation before starting.

T01 Cycle start prohibit 0142

Details

In manual coordinate system setting

Automatic start is not allowed during the manual coordinate system setting.

Remedy

The system restarts after either of the manual coordinate system setting completion signal or the error end signal has been turned ON.

T01 In manual measurement 0143**Details**

Automatic start is disabled because manual measurement is in execution.

Remedy

- Execute automatic start after the manual measurement is completed.

T01 Auto start in retract/return 0145**Details**

Auto start is disabled because the auto start in retract/return is in execution.

Remedy

- Execute the auto start after the axis was returned to the interrupt point with return start signal.

T01 Cycle start prohibit 0180**Details**

Automatic start became disabled while servo auto turning is enabled.

Remedy

- Set "#1164 ATS" to "0" when the servo auto turning is not executed.

T01 Cycle start prohibit 0190**Details**

Automatic start is not possible because the setting of setup parameters is enabled.

Remedy

- Refer to the manual issued by the machine tool builder.

T01 Cycle start prohibit 0191**Details**

Automatic start was attempted while a file was being deleted/written.

Remedy

- Wait for the file to be deleted/written and then execute the automatic start.

T01 Cycle st. prohibit (Term exp'd) 0193**Details**

Automatic start is not possible because the valid term has been expired.

Remedy

- Obtain a decryption code from the machine tool builder and input it in the NC, then turn the power ON again.

T02 H/W stroke end axis exists 0201**Details**

An axis is at the stroke end.

Remedy

- Manually move the axis away from the stroke end limit switch.
- Correct the machining program.

T02 S/W stroke end axis exists 0202**Details**

An axis is at the stored stroke limit.

Remedy

- Manually move the axis.
- Correct the machining program.

T02 Reset signal ON 0203**Details**

The reset has been entered.

Remedy

- The program execution position has returned to the start of the program. Execute automatic operation from the start of the machining program.

T02 Auto operation pause signal ON 0204

Details

The "feed hold" switch is ON.

Remedy

- Press the CYCLE START switch to resume the automatic operation.

T02 Operation mode changed 0205

Details

The operation mode has changed to another mode during automatic operation.

Remedy

- Return to the original automatic operation mode, and press the CYCLE START switch to resume the automatic operation.

T02 Acc/dec time cnst too large 0206

Details

The acceleration and deceleration time constants are too large. (This alarm occurs with the system alarm Z59.)

Remedy

- Set a larger value for "#1206 G1bF(Maximum speed)".
- Set a smaller value for "#1207 G1btL(Time constant)".
- Set a lower cutting speed.

T02 Abs posn detect alarm occurred 0215

Details

An absolute position detection alarm occurred.

Remedy

- Clear the absolute position detection alarm.

T02 Aux axis changeover error 0220

Details

A travel command was issued to an auxiliary axis.

Remedy

- Turn ON the "NC axis control selection" signal and press the CYCLE START switch to restart the automatic operation with.

T03 Single block stop signal ON 0301

Details

The SINGLE BLOCK switch on the machine operation panel is ON.
The SINGLE BLOCK or MACHINE LOCK switch changed.

Remedy

- Press the CYCLE START switch to resume the automatic operation.

T03 Block stop cmdnd in user macro 0302

Details

A block stop command was issued in the user macro program.

Remedy

- Press the CYCLE START switch to resume the automatic operation.

T03 Operation mode changed 0303

Details

Automatic mode changed to another automatic mode.

Remedy

- Return to the original automatic operation mode, and press the CYCLE START switch to resume the automatic operation.

T03 MDI completed 0304**Details**

MDI operation has ended the last block.

Remedy

- Set the MDI operation again, and press the CYCLE START switch to start the MDI operation.

T03 Block start interlock 0305**Details**

The interlock signal, which locks the block start, is ON.

Remedy

- Correct the sequence program.

T03 Cutting blk start interlock 0306**Details**

The interlock signal, which locks the block cutting start, is ON.

Remedy

- Correct the sequence program.

T03 Inclined Z offset change 0310**Details**

The "inclined axis control: No Z axis compensation" signal has turned ON or OFF during the program operation.

Remedy

- Press the CYCLE START switch to resume the automatic operation.

T03 Aux axis changeover error 0330**Details**

The "NC axis control selection" signal was turned OFF while a NC axis was traveling.

Remedy

- Turn the "NC axis control selection" signal ON and press the CYCLE START switch to resume the automatic operation.

T04 Collation stop 0401**Details**

Collation stop occurred.

Remedy

- Execute the automatic start to resume the automatic operation.

T10 Fin wait 0ooo

Details

The following Nos. are shown during the operation of the corresponding completion wait factor. The numbers will disappear when the operation is completed.

The completion wait factor is indicated with four digits (in hexadecimal).

Display format of completion wait factor

0 _ _ _ _
(a)(b)(c)

Each of the hexadecimal numbers (a), (b) and (c) indicates the following details.

(a)

bit0: In dwell execution

bit1: Waiting for G11 completion

bit3: Unclamp signal wait (Note 1)

(b)

bit0: Waiting for spindle position to be looped

bit1: Waiting for optimum acceleration/deceleration selection completion

bit3: Door open (Note 2)

(c)

bit0: Waiting for MSTB completion

bit1: Waiting for rapid traverse deceleration

bit2: Waiting for cutting speed deceleration

bit3: Waiting for spindle orientation completion

(Note 1) This shows the wait state for the unclamp signal's ON/OFF for the index table indexing.

(Note 2) This shows the door open state caused by the door interlock function.

T11 Fin wait 0010 (Factors for waiting completion)

Details

The following Nos. are shown during the operation of the corresponding completion wait factor. The numbers will disappear when the operation is completed.

The completion wait factor is indicated with four digits (in hexadecimal).

Display format of completion wait factor

0 _ _ _ _
(a)(b)(c)

Each of the hexadecimal numbers (a), (b) and (c) indicates the following details.

bit0: Operation alarm display being postponed

Remedy

The parameter "#1342 AlmDly" may be able to postpone displaying a part of an operation alarm, depending on the setting.

This stop code will remain displayed while any alarm is being postponed.

And it will disappear if the postponed alarm is displayed or canceled.

1.3 Servo/Spindle Alarms (S)

1.3.1 Servo Errors (S01/S03/S04)

Servo alarm is displayed in the following format.

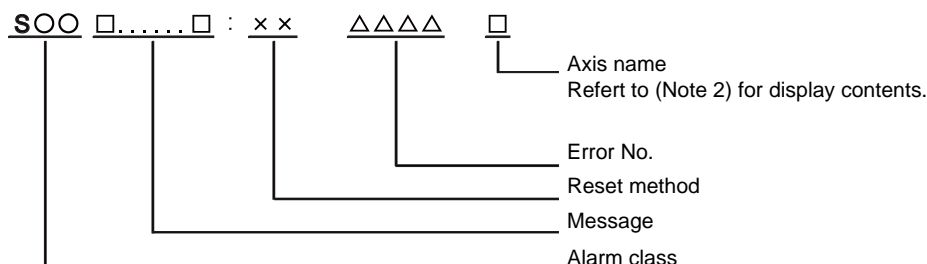

Alarm class	Message	Reset method	Resetting methods
S01	Servo alarm	PR	After removing the cause of the alarm, reset the alarm by turning the NC power ON again.
S03	Servo alarm	NR	After removing the cause of the alarm, reset the alarm by inputting the NC RESET key.
S04	Servo alarm	AR	After removing the cause of the alarm, reset the alarm by turning the drive unit power ON again.

Error No. consists of four digits (0010 to). Servo alarms are explained in ascending order of the error No. The four digits on the left part of each alarm indicate the error No.

(Note 1) For the details of servo alarms, refer to your drive unit's instruction manual.

(Note 2) The axis names are shown as followings.

[For M700UM]

NC axis: axis name

PLC axis : "P1", "P2", "P3", "P4", "P5", "P6"

Spindle : "S1", "S2", "S3", "S4"

[For M700BM]

<For Special display unit or MELDAS screen>

NC axis: axis name

PLC axis : axis name is displayed with small letters when axis name is set.

"1", "2", "3", "4", "5", "6" when axis name is not set.

Spindle : "S", "T", "M", "N"

<For Mitsubishi HMI screen>

NC axis: axis name

PLC axis : "P1", "P2", "P3", "P4", "P5", "P6"

Spindle : "S1", "S2", "S3", "S4"

Drive unit alarms

0010 Insufficient voltage

Details

A drop of bus voltage was detected in main circuit.

- Servo stop method: Dynamic stop
- Spindle stop method: Coast to a stop

0011 Axis selection error

Details

The axis selection rotary switch has been incorrectly set.

- Servo stop method: Initial error
- Spindle stop method: Initial error

0012 Memory error 1

Details

- A hardware error was detected during the power ON self-check.
- Servo stop method: Initial error
- Spindle stop method: Initial error

0013 Software processing error 1

Details

- An error was detected for the software execution state.
- Servo stop method: Dynamic stop
- Spindle stop method: Coast to a stop

0014 Software processing error 2

Details

- The current processing processor does not operate correctly.
- Servo stop method: Dynamic stop
- Spindle stop method: Coast to a stop

0016 Init mag pole pos detect err

Details

- In the built-in motor which uses the absolute position detector, the servo ON has been set before the magnetic pole shift amount is set.
- The magnetic pole position, detected in the initial magnetic pole position detection control, is not correctly set.
- Servo stop method: Dynamic stop
- Spindle stop method: Coast to a stop

0017 A/D converter error

Details

- A current feedback error was detected.
- Servo stop method: Dynamic stop
- Spindle stop method: Coast to a stop

0018 Motor side dtc: Init commu err

Details

- An error was detected in the initial communication with the motor side detector.
- Servo stop method: Initial error
- Spindle stop method: Initial error

0019 Detector commu err in syn cont

Details

- An error of the shared detector on the machine side was detected on the secondary axis of the speed command synchronization control.
- Servo stop method: Dynamic stop

001A Machine side dtc: Init comu er

Details

- An error was detected in the initial communication with the machine side detector.
- Servo stop method: Initial error
- Spindle stop method: Initial error

001B Machine side dtc: Error 1**Details**

An error was detected by the detector connected to the machine side.

The error details are different according to the detector type.

- Servo stop method: Dynamic stop
- Spindle stop method: Coast to a stop
- [Detector alarm (Servo drive unit)]
- OSA105, OSA105ET2A, OSA166, OSA166ET2NA(MITSUBISHI) Memory alarm
- OSA18() CPU alarm
- MDS-B-HR() Memory error
- MBA405W(MITSUBISHI) CPU error
- AT343, AT543, AT545(Mitsutoyo) Initialization error
- LC193M, LC493M, LC195M, LC495M, RCN223M, RCN227M, RCN727M, RCN827M, EIB Series(HEIDENHAIN) Initialization error
- MPRZ Scale(MHI) Installation accuracy fault
- SR75, SR85, SR77, SR87, RU77(Magnescale) Laser diode error
- RL40N Series(Renishaw) Initialization error
- [Detector alarm (Spindle drive unit)]
- TS5690, TS5691(MITSUBISHI) Memory error
- MDS-B-HR() Initialization error
- OSA18() CPU error
- MBE405W(MITSUBISHI) CPU error
- EIB Series(HEIDENHAIN) Initialization error
- MPC scale(MHI) Installation accuracy fault

(Note) A driver processes all reset types of alarms as "PR". However, "AR" will be applied according to the detector.

001C Machine side dtc: Error 2**Details**

An error was detected by the detector connected to the machine side.

The error details are different according to the detector type.

- Servo stop method: Dynamic stop
- Spindle stop method: Coast to a stop
- [Detector alarm (Servo drive unit)]
- OSA105, OSA105ET2A, OSA166, OSA166ET2NA(MITSUBISHI) LED alarm
- MBA405W(MITSUBISHI) Waveform error
- AT343, AT543, AT545(Mitsutoyo) EEPROM error
- LC193M, LC493M, LC195M, LC495M, RCN223M, RCN227M, RCN727M, RCN827M, EIB Series(HEIDENHAIN) EEPROM error
- SR75, SR85, SR77, SR87, RU77(Magnescale) System memory error
- [Detector alarm (Spindle drive unit)]
- TS5690, TS5691(MITSUBISHI) Waveform error
- MBE405W(MITSUBISHI) Waveform error
- EIB Series(HEIDENHAIN) EEPROM error

(Note) A driver processes all reset types of alarms as "PR". However, "AR" will be applied according to the detector.

001D Machine side dtc: Error 3

Details

An error was detected by the detector connected to the machine side.
The error details are different according to the detector type.

- Servo stop method: Dynamic stop
- Spindle stop method: Coast to a stop
- [Detector alarm (Servo drive unit)]
- OSA105, OSA105ET2A, OSA166, OSA166ET2NA(MITSUBISHI) Data alarm
- OSA18() Data alarm
- MDS-B-HR() Data error
- MBA405W(MITSUBISHI) Data error
- AT343, AT543, AT545(Mitsutoyo) Photoelectric type, static capacity type data mismatch
- LC193M, LC493M, LC195M, LC495M, RCN223M, RCN227M, RCN727M, RCN827M, EIB Series(HEIDENHAIN) Relative/ absolute position data mismatch
- MPRZ Scale(MHI) Detection position deviance
- SR75, SR85, SR77, SR87, RU77(Magnescape) Encoder mismatch error
- SAM/SVAM/GAM/LAN Series (FAGOR) Absolute position detection error
- RL40N Series (Renishaw) Absolute position data error

[Detector alarm (Spindle drive unit)]

- MDS-B-HR() Data error
 - OSA18() Data error
 - MBE405W(MITSUBISHI) Data error
 - MPC1 scale(MHI) Detection position deviance
- (Note) A driver processes all reset types of alarms as "PR". However, "AR" will be applied according to the detector.

001E Machine side dtc: Error 4

Details

An error was detected by the detector connected to the machine side.
The error details are different according to the detector type.

- Servo stop method: Dynamic stop
- Spindle stop method: Coast to a stop
- [Detector alarm (Servo drive unit)]
- AT343, AT543, AT545(Mitsutoyo) ROM/RAM error
- LC193M, LC493M, LC195M, LC495M, RCN223M, RCN227M, RCN727M, RCN827M, EIB Series(HEIDENHAIN) ROM/RAM error
- MPRZ Scale(MHI) Scale breaking
- SAM/SVAM/GAM/LAM Series (FAGOR) H/W error
- [Detector alarm (Spindle drive unit)]
- MPC1 scale(MHI) Scale breaking

(Note) A driver processes all reset types of alarms as "PR". However, "AR" will be applied according to the detector.

001F Machine side dtc: Commu error

Details

An error was detected in the communication with the machine side detector.

- Servo stop method: Dynamic stop
- Spindle stop method: Coast to a stop

0021 Machine side dtc: No signal

Details

In the machine side detector, ABZ-phase feedback cannot be returned even when the motor moves.

- Servo stop method: Dynamic stop
- Spindle stop method: Coast to a stop

0022 Detector data error

Details

An error was detected in the feedback data from the position detector.

- Servo stop method: Dynamic stop

0023 Excessive speed error

Details

The state that there is a difference between the actual speed and command speed continued for longer than the excessive speed deviation timer setting.

- Spindle stop method: Coast to a stop

0024 Grounding**Details**

- The motor power cable is in contact with FG (Frame Ground).
- Servo stop method: Dynamic stop
 - Spindle stop method: Coast to a stop

0025 Absolute position data lost**Details**

- The absolute position data was lost in the detector.
- Servo stop method: Initial error

0026 Unused axis error**Details**

- In the multi-axis drive unit, there is an axis set to free, and the other axis detected a power module error.
- Servo stop method: Dynamic stop
 - Spindle stop method: Coast to a stop

0027 Machine side dtc: Error 5**Details**

- An error was detected by the detector connected to the machine side.
The error details are different according to the detector type.
- Servo stop method: Dynamic stop
 - Spindle stop method: Coast to a stop
- [Detector alarm (Servo drive unit)]
- MDS-B-HR() Scale not connected
 - AT343, AT543, AT545(Mitsutoyo) CPU error
 - LC193M, LC493M, LC195M, LC495M, RCN223M, RCN227M, RCN727M, RCN827M, EIB Series(HEIDENHAIN) CPU error
 - MPRZ Scale(MHI) Absolute value detection fault
 - SAM/SVAM/GAM/LAN Series (FAGOR) CPU error
- [Detector alarm (Spindle drive unit)]
- MDS-B-HR() Connection error
 - EIB Series(HEIDENHAIN) CPU error
- (Note) A driver processes all reset types of alarms as "PR". However, "AR" will be applied according to the detector.

0028 Machine side dtc: Error 6**Details**

- An error was detected by the detector connected to the machine side.
The error details are different according to the detector type.
- Servo stop method: Dynamic stop
 - Spindle stop method: Coast to a stop
- [Detector alarm (Servo drive unit)]
- AT343, AT543, AT545(Mitsutoyo) Photoelectric type overspeed
 - LC193M, LC493M, LC195M, LC495M, RCN223M, RCN227M, RCN727M, RCN827M, EIB Series(HEIDENHAIN) Overspeed
 - SR75, SR85, SR77, SR87, RU77(Magnescale) Over speed
 - RL40N Series (Renishaw) Overspeed error
- [Detector alarm (Spindle drive unit)]
- TS5690, TS5691(MITSUBISHI) Overspeed
 - EIB Series(HEIDENHAIN) Overspeed
- (Note) A driver processes all reset types of alarms as "PR". However, "AR" will be applied according to the detector.

0029 Machine side dtc: Error 7

Details

An error was detected by the detector connected to the machine side.
The error details are different according to the detector type.

- Servo stop method: Dynamic stop
- Spindle stop method: Coast to a stop
- [Detector alarm (Servo drive unit)]
- AT343, AT543, AT545(Mitsutoyo) Static capacity type error
- LC193M, LC493M, LC195M, LC495M, RCN223M, RCN227M, RCN727M, RCN827M, EIB Series(HEIDENHAIN) Absolute position data error
- MPRZ Scale(MHI) Gain fault
- SR75, SR85, SR77, SR87, RU77(Magnescale) Absolute position data error
- [Detector alarm (Spindle drive unit)]
- MPCl scale(MHI) Gain fault

(Note) A driver processes all reset types of alarms as "PR". However, "AR" will be applied according to the detector.

002A Machine side dtc: Error 8

Details

An error was detected by the detector connected to the machine side.
The error details are different according to the detector type.

- Servo stop method: Dynamic stop
- Spindle stop method: Coast to a stop
- [Detector alarm (Servo drive unit)]
- MBA405W(MITSUBISHI) Count error
- AT343, AT543, AT545(Mitsutoyo) Photoelectric type error
- LC193M, LC493M, LC195M, LC495M, RCN223M, RCN227M, RCN727M, RCN827M, EIB Series(HEIDENHAIN) Relative position data error
- MPRZ Scale(MHI) Phase fault
- SR75, SR85, SR77, SR87, RU77(Magnescale) Relative position data error
- [Detector alarm (Spindle drive unit)]
- TS5690, TS5691(MITSUBISHI) Relative position data error
- MBE405W(MITSUBISHI) Count error
- EIB Series(HEIDENHAIN) Relative position data error
- MPCl scale(MHI) Phase fault

(Note) A driver processes all reset types of alarms as "PR". However, "AR" will be applied according to the detector.

002B Motor side dtc: Error 1

Details

An error was detected by the detector connected to the motor side.
The error details are different according to the detector type.

- Servo stop method: Dynamic stop
- Spindle stop method: Coast to a stop
- [Detector alarm (Servo drive unit)]
- OSA105, OSA105ET2A, OSA166, OSA166ET2NA(MITSUBISHI) Memory alarm
- OSA18() CPU alarm
- MDS-B-HR() Memory error
- AT343, AT543, AT545(Mitsutoyo) Initialization error
- LC193M, LC493M, RCN223M, RCN227M, RCN727M, RCN827M, EIB Series(HEIDENHAIN) Initialization error
- MPRZ Series(MHI) Installation accuracy fault
- SR75, SR85, SR77, SR87, RU77(Magnescale) Laser diode error
- [Detector alarm (Spindle drive unit)]
- TS5690, TS5691(MITSUBISHI) Memory error
- MDS-B-HR() Initialization error
- OSA18() CPU error
- EIB Series(HEIDENHAIN) Initialization error
- MPCl scale(MHI) Installation accuracy fault

(Note) A driver processes all reset types of alarms as "PR". However, "AR" will be applied according to the detector.

002C Motor side dtc: Error 2**Details**

An error was detected by the detector connected to the motor side.

The error details are different according to the detector type.

- Servo stop method: Dynamic stop
- Spindle stop method: Coast to a stop
- [Detector alarm (Servo drive unit)]
- OSA105, OSA105ET2A, OSA166, OSA166ET2NA(MITSUBISHI) LED alarm
- AT343, AT543, AT545(Mitsutoyo) EEPROM error
- LC193M, LC493M, RCN223M, RCN227M, RCN727M, RCN827M, EIB Series(HEIDENHAIN) EEPROM error
- SR75, SR85, SR77, SR87, RU77(Magnescale) System memory error
- [Detector alarm (Spindle drive unit)]
- TS5690, TS5691(MITSUBISHI) Waveform error
- EIB Series(HEIDENHAIN) EEPROM error

(Note) A driver processes all reset types of alarms as "PR". However, "AR" will be applied according to the detector.

002D Motor side dtc: Error 3**Details**

An error was detected by the detector connected to the motor side.

The error details are different according to the detector type.

- Servo stop method: Dynamic stop
- Spindle stop method: Coast to a stop
- [Detector alarm (Servo drive unit)]
- OSA105, OSA105ET2A, OSA166, OSA166ET2NA(MITSUBISHI) Data alarm
- OSA18() Data alarm
- MDS-B-HR() Data error
- AT343, AT543, AT545(Mitsutoyo) Photoelectric type, static capacity type data mismatch
- LC193M, LC493M, RCN223M, RCN227M, RCN727M, RCN827M, EIB Series(HEIDENHAIN) Relative/ absolute position data mismatch
- MPRZ Series(MHI) Detection position deviance
- SR75, SR85, SR77, SR87, RU77(Magnescale) Encoder mismatch error
- SAM/SVAM/GAM/LAN Series (FAGOR) Absolute position detection error
- [Detector alarm (Spindle drive unit)]
- MDS-B-HR() Data error
- OSA18() Data error
- MPC1 scale(MHI) Detection position deviance

(Note) A driver processes all reset types of alarms as "PR". However, "AR" will be applied according to the detector.

002E Motor side dtc: Error 4**Details**

An error was detected by the detector connected to the motor side.

The error details are different according to the detector type.

- Servo stop method: Dynamic stop
- Spindle stop method: Coast to a stop
- [Detector alarm (Servo drive unit)]
- AT343, AT543, AT545(Mitsutoyo) ROM/RAM error
- LC193M, LC493M, RCN223M, RCN227M, RCN727M, RCN827M, EIB Series(HEIDENHAIN) ROM/RAM error
- MPRZ Series(MHI) Scale breaking
- SAM/SVAM/GAM/LAM Series (FAGOR) H/W error
- [Detector alarm (Spindle drive unit)]
- MPC1 scale(MHI) Scale breaking

(Note) A driver processes all reset types of alarms as "PR". However, "AR" will be applied according to the detector.

002F Motor side dtc: Commu error**Details**

An error was detected in the communication with the motor side detector.

- Servo stop method: Dynamic stop
- Spindle stop method: Coast to a stop

0030 Over regeneration

Details

- Over-regeneration level exceeded 100%. The regenerative resistor is overloaded.
- Servo stop method: Dynamic stop
- Spindle stop method: Coast to a stop

0031 Overspeed

Details

- The motor speed exceeded the allowable speed.
- Servo stop method: Deceleration stop enabled
- Spindle stop method: Deceleration stop enabled

0032 Power module overcurrent

Details

- The power module detected the overcurrent.
- Servo stop method: Dynamic stop
- Spindle stop method: Coast to a stop

0033 Overvoltage

Details

- The bus voltage in main circuit exceeded the allowable value.
- Servo stop method: Dynamic stop
- Spindle stop method: Coast to a stop

0034 NC-DRV commu: CRC error

Details

- The data received from the NC was outside the setting range.
- Servo stop method: Deceleration stop enabled
- Spindle stop method: Deceleration stop enabled

0035 NC command error

Details

- The travel command data received from the NC was excessive.
- Servo stop method: Deceleration stop enabled
- Spindle stop method: Deceleration stop enabled

0036 NC-DRV commu: Commu error

Details

- The communication with the NC was interrupted.
- Servo stop method: Deceleration stop enabled
- Spindle stop method: Deceleration stop enabled

0037 Initial parameter error

Details

- An incorrect set value was detected among the parameters send from the NC at the power ON.
- In the SLS (Safely Limited Speed) function, an error was detected in the relation between the safety speed and safety rotation number in the speed observation mode.
- Servo stop method: Initial error
- Spindle stop method: Initial error

0038 NC-DRV commu: Protocol error 1

Details

- An error was detected in the communication frames received from the NC.
- Or, removing an axis or changing an axis was performed in the synchronous control.
- Servo stop method: Deceleration stop enabled
- Spindle stop method: Deceleration stop enabled

0039 NC-DRV commu: Protocol error 2**Details**

- An error was detected in the axis data received from the NC.
Or, in changing an axis, the parameter setting of the synchronous control was applied when the axis was installed.
- Servo stop method: Deceleration stop enabled
 - Spindle stop method: Deceleration stop enabled

003A Overcurrent**Details**

- Excessive motor drive current was detected.
- Servo stop method: Dynamic stop
 - Spindle stop method: Coast to a stop

003B Power module overheat**Details**

- The power module detected an overheat.
- Servo stop method: Dynamic stop
 - Spindle stop method: Coast to a stop

003C Regeneration circuit error**Details**

- An error was detected in the regenerative transistor or in the regenerative resistor.
- Servo stop method: Dynamic stop

003D Pw sply volt err acc/dec**Details**

- A motor control error during acceleration/deceleration, due to a power voltage failure, was detected.
- Servo stop method: Dynamic stop

003E Magnet pole pos detect err**Details**

- The magnetic pole position, detected in the magnetic pole position detection control, is not correctly detected.
- Servo stop method: Dynamic stop
 - Spindle stop method: Coast to a stop

0041 Feedback error 3**Details**

- Either a missed feedback pulse in the motor side detector or an error in the Z-phase was detected in the full closed loop system.
- Servo stop method: Dynamic stop
 - Spindle stop method: Coast to a stop

0042 Feedback error 1**Details**

- Either a missed feedback pulse in the position detection or an error in the Z-phase was detected. Or the distance-coded reference check error exceeded the allowable value when the distance-coded reference scale was used.
- Servo stop method: Dynamic stop
 - Spindle stop method: Coast to a stop

0043 Feedback error 2**Details**

- An excessive difference in feedback was detected between the machine side detector and the motor side detector.
- Servo stop method: Dynamic stop
 - Spindle stop method: Coast to a stop

0045 Fan stop

Details

- An overheat of the power module was detected during the cooling fan stopping.
- Servo stop method: Dynamic stop
 - Spindle stop method: Coast to a stop

0046 Motor overheat

Details

- Either the motor or the motor side detector detected an overheat.
 Or, the thermistor signal receiving circuit of the linear motor or DD motor was disconnected.
 Or, the thermistor signal receiving circuit was short-circuited.
- Servo stop method: Deceleration stop enabled
 - Spindle stop method: Deceleration stop enabled

0048 Motor side dtc: Error 5

Details

- An error was detected by the detector connected to the main side.
 The error details are different according to the connected detector.
- Servo stop method: Dynamic stop
 - Spindle stop method: Coast to a stop
- [Detector alarm (Servo drive unit)]
- MDS-B-HR() Scale not connected
 - AT343, AT543, AT545(Mitsutoyo) CPU error
 - LC193M, LC493M, RCN223M, RCN227M, RCN727M, RCN827M, EIB Series(HEIDENHAIN) CPU error
 - MPRZ Series(MHI) Absolute value detection fault
 - SAM/SVAM/GAM/LAM Series (FAGOR) CPU error
- [Detector alarm (Spindle drive unit)]
- MDS-B-HR() Connection error
 - EIB Series(HEIDENHAIN) CPU error
- (Note) A driver processes all reset types of alarms as "PR". However, "AR" will be applied according to the detector.

0049 Motor side dtc: Error 6

Details

- An error was detected by the detector connected to the main side.
 The error details are different according to the connected detector.
- Servo stop method: Dynamic stop
 - Spindle stop method: Coast to a stop
- [Detector alarm (Servo drive unit)]
- AT343, AT543, AT545(Mitsutoyo) Photoelectric type overspeed
 - LC193M, LC493M, RCN223M, RCN227M, RCN727M, RCN827M, EIB Series(HEIDENHAIN) Overspeed
 - SR75, SR85, SR77, SR87, RU77(Magnescale) Over speed
- [Detector alarm (Spindle drive unit)]
- TS5690, TS5691(MITSUBISHI) Overspeed
 - EIB Series(HEIDENHAIN) Overspeed
- (Note) A driver processes all reset types of alarms as "PR". However, "AR" will be applied according to the detector.

004A Motor side dtc: Error 7

Details

- An error was detected by the detector connected to the main side.
 The error details are different according to the connected detector.
- Servo stop method: Dynamic stop
 - Spindle stop method: Coast to a stop
- [Detector alarm (Servo drive unit)]
- AT343, AT543, AT545(Mitsutoyo) Static capacity type error
 - LC193M, LC493M, RCN223M, RCN227M, RCN727M, RCN827M, EIB Series(HEIDENHAIN) Absolute position data error
 - MPRZ Series(MHI) Gain fault
 - SR75, SR85, SR77, SR87, RU77(Magnescale) Absolute position data error
- [Detector alarm (Spindle drive unit)]
- MPC1 scale(MHI) Gain fault
- (Note) A driver processes all reset types of alarms as "PR". However, "AR" will be applied according to the detector.

004B Motor side dtc: Error 8**Details**

An error was detected by the detector connected to the main side.
The error details are different according to the connected detector.

- Servo stop method: Dynamic stop
 - Spindle stop method: Coast to a stop
- [Detector alarm (Servo drive unit)]
- AT343, AT543, AT545(Mitsutoyo) Photoelectric type error
 - LC193M, LC493M, RCN223M, RCN227M, RCN272M, RCN827M, EIB Series(HEIDENHAIN) Relative position data error
 - MPRZ Series(MHI) Phase fault
 - SR75, SR85, SR77, SR87, RU77(Magnescale) Relative position data error
- [Detector alarm (Spindle drive unit)]
- TS5690, TS5691(MITSUBISHI) Relative position data error
 - EIB Series(HEIDENHAIN) Relative position data error
 - MPCI scale(MHI) Phase fault

(Note) A driver processes all reset types of alarms as "PR". However, "AR" will be applied according to the detector.

004C Current err mag pole estim**Details**

Current detection failed at the initial magnetic pole estimation.

- Servo stop method: Dynamic stop
- Spindle stop method: Coast to a stop

004D Dual signal error**Details**

An error was detected in the signal related to the dual signal.

- Servo stop method: Dynamic stop
- Spindle stop method: Coast to a stop

004E NC command mode error**Details**

An error was detected in the control mode send from the NC.

- Servo stop method: Deceleration stop enabled
- Spindle stop method: Deceleration stop enabled

004F Instantaneous power interrupt**Details**

The control power supply has been shut down for 50ms or more.

- Servo stop method: Deceleration stop enabled
- Spindle stop method: Deceleration stop enabled

0050 Overload 1**Details**

Overload detection level became 100% or more. The motor or the drive unit is overloaded.

- Servo stop method: Deceleration stop enabled
- Spindle stop method: Deceleration stop enabled

0051 Overload 2**Details**

In a servo system, current command of 95% or more of the unit's max. current was given continuously for 1 second or longer. In a spindle system, current command of 95% or more of the motor's max. current was given continuously for 1 second or longer.

- Servo stop method: Deceleration stop enabled
- Spindle stop method: Deceleration stop enabled

0052 Excessive error 1**Details**

A position tracking error during servo ON was excessive.

- Servo stop method: Deceleration stop enabled
- Spindle stop method: Deceleration stop enabled

0053 Excessive error 2**Details**

A position tracking error during servo OFF was excessive.
 - Servo stop method: Dynamic stop

0054 Excessive error 3**Details**

There was no motor current feedback when the alarm "Excessive error 1" was detected.
 - Servo stop method: Dynamic stop
 - Spindle stop method: Coast to a stop

0056 Commanded speed error**Details**

In the C-axis control mode, excessive speed error was detected.
 - Spindle stop method: Deceleration stop enabled

0058 Collision detection 1: G0**Details**

A disturbance torque exceeded the allowable value in rapid traverse modal (G0).
 - Servo stop method: Maximum capacity deceleration stop

0059 Collision detection 1: G1**Details**

A disturbance torque exceeded the allowable value in the cutting feed modal (G1).
 - Servo stop method: Maximum capacity deceleration stop

005A Collision detection 2**Details**

A current command with the maximum drive unit current value was detected.
 - Servo stop method: Maximum capacity deceleration stop

005B Safely limited: Cmd spd err**Details**

A commanded speed exceeding the safely limited speed was detected in the safely limited mode.
 - Servo stop method: Deceleration stop enabled
 - Spindle stop method: Deceleration stop enabled

005D Safely limited: Door stat err**Details**

The door state signal input in the NC does not coincide with the door state signal input in the drive unit in the safely limited mode. Otherwise, door open state was detected in normal mode.
 - Servo stop method: Deceleration stop enabled
 - Spindle stop method: Deceleration stop enabled

005E Safely limited: FB speed err**Details**

A motor speed exceeding the safely limited speed was detected in the safely limited mode.
 - Servo stop method: Deceleration stop enabled
 - Spindle stop method: Deceleration stop enabled

005F External contactor error**Details**

A contact of the external contactor is welding.
 - Servo stop method: Deceleration stop enabled
 - Spindle stop method: Deceleration stop enabled

0080 Motor side dtc: cable err**Details**

The cable type of the motor side detector cable is for rectangular wave signal.
 - Servo stop method: Initial error

0081 Machine side dtc: cable err**Details**

The cable type of the machine side detector cable does not coincide with the detector type which is set by the parameter.

- Servo stop method: Initial error

0087 Drive unit communication error**Details**

The communication frame between drive units was aborted.

- Servo stop method: Dynamic stop
- Spindle stop method: Coast to a stop

0088 Watchdog**Details**

The drive unit does not operate correctly.

- Servo stop method: Dynamic stop
- Spindle stop method: Coast to a stop

008A Drivers commu data error 1**Details**

The communication data 1 between drivers exceeded the tolerable value in the communication between drive units.

- Servo stop method: Dynamic stop
- Spindle stop method: Coast to a stop

008B Drivers commu data error 2**Details**

The communication data 2 between drivers exceeded the tolerable value in the communication between drive units.

- Servo stop method: Dynamic stop
- Spindle stop method: Coast to a stop

Power supply alarms

0061 Pw sply: Pwr module overcurrnt

Details

Overcurrent protection function in the power module has started its operation.

0062 Pw sply: Frequency error

Details

The input power supply frequency increased above the specification range.

0066 Pw sply: Process error

Details

An error occurred in the process cycle.

0067 Pw sply: Phase interruption

Details

An open-phase condition was detected in input power supply circuit.

0068 Pw sply: Watchdog

Details

The system does not operate correctly.

0069 Pw sply: Grounding

Details

The motor power cable is in contact with FG (Frame Ground).

006A Pw sply: Ext contactor weld

Details

A contact of the external contactor is welding.

006B Pw sply: Rush circuit error

Details

An error was detected in the rush circuit.

006C Pw sply: Main circuit error

Details

An error was detected in charging operation of the main circuit capacitor.

006D Pw sply: Parameter error

Details

An error was detected in the parameter sent from the drive unit.

006E Pw sply: H/W error

Details

An error was detected in the internal memory.
 An error was detected in the A/D converter.
 An error was detected in the unit identification.

006F Power supply error

Details

No power supply is connected to the drive unit, or a communication error was detected.

0070 Pw sply: External EMG stop err

Details

A mismatch of the external emergency stop input and NC emergency stop input continued for 30 seconds.

0071 Pw sply: Instant pwr interrupt**Details**

The power was momentarily interrupted.

0072 Pw sply: Fan stop**Details**

A cooling fan built in the power supply unit stopped, and overheat occurred in the power module.

0073 Pw sply: Over regeneration**Details**

Over-regeneration detection level became over 100%. The regenerative resistor is overloaded. This alarm cannot be reset for 15 min from the occurrence to protect the regeneration resistor. Leave the drive system energized for more than 15 min, then turn the power ON to reset the alarm.

0074 Pw sply: Option unit error**Details**

An alarm was detected in the power backup unit (power supply option unit). Check the LED display on the power backup unit to identify what alarm is occurring to the unit. Refer to the instruction manual of your drive unit for details.

0075 Pw sply: Overvoltage**Details**

L+ and L- bus voltage in main circuit exceeded the allowable value. As the voltage between L+ and L- is high immediately after this alarm, another alarm may occur if this alarm is reset in a short time. Wait more than 5 min before resetting so that the voltage drops.

0076 Pw sply: Function setting err**Details**

The rotary switch setting of external emergency stop is not correct, or a wrong external emergency stop signal is input.
Undefined number was selected for the rotary switch setting of the power supply.

0077 Pw sply: Power module overheat**Details**

Thermal protection function in the power module has started its operation.

1.3.2 Initial Parameter Errors (S02)

S02 Initial parameter error:PR 2201-2456 (Axis name)

Details

The servo parameter setting data is illegal.
The alarm No. is the No. of the servo parameter where the error occurred.

Remedy

Check the descriptions for the appropriate servo parameters and correct them.
Even when the parameter is set to a value within the setting range, an error is occurring due to the hardware compatibility or specifications or in relation to several other parameters.
Refer to "Parameter Numbers during Initial Parameter Error" of each drive unit instruction manual for details.

S02 Initial parameter error:PR 13001-13256 (Axis name)

Details

Parameter error
The spindle parameter setting data is illegal.
The alarm No. is the No. of the spindle parameter where the error occurred.

Remedy

Check the descriptions for the appropriate spindle parameters and correct them.
Even when the parameter is set to a value within the setting range, an error is occurring due to the hardware compatibility or specifications or in relation to several other parameters.
Refer to "Parameter Numbers during Initial Parameter Error" of each drive unit instruction manual for details.

1.3.3 Safety Function Errors (S05)

S05 Safety function error (Alarm) (Axis name)

Details

Alarms are displayed in four digits(hexadecimal).
- Reset method : NR

Display format of alarms

000_
(a)

(a) means as follows in hexadecimal.

bit0 : STO signal has been input when no parameter to enable STO was set. (Only for drive units corresponding to STO function.)

- Axis type : All types
- Stop method : Dynamic stop
- During release of axis : Enable

bit1 : STO signal has been input when the servo is ON.

- Axis type : All types
- Stop method : Dynamic stop
- During release of axis : Enable

bit2 : STO signal error

- Axis type : All types
- Stop method : Dynamic stop
- During release of axis : Enable

1.3.4 Parameter Errors (S51)

S51 Parameter error 2201-2456 (Axis name)

Details

Servo parameter setting data is illegal.

The alarm No. is the No. of the servo parameter where the warning occurred.

Remedy

Check the descriptions for the appropriate servo parameters and correct them.

Even when the parameter is set to a value within the setting range, an error is occurring due to the hardware compatibility or specifications or in relation to several other parameters.

Refer to "Parameter Numbers during Initial Parameter Error" of each drive unit instruction manual for details.

S51 Parameter error 13001-13256 (Axis name)

Details

Spindle parameter setting data is illegal.

The alarm No. is the No. of the spindle parameter where the warning occurred.

Remedy

Check the descriptions for the appropriate spindle parameters and correct them.

Even when the parameter is set to a value within the setting range, an error is occurring due to the hardware compatibility or specifications or in relation to several other parameters.

Refer to "Parameter Numbers during Initial Parameter Error" of each drive unit instruction manual for details.

1.3.5 Servo Warnings (S52)

Servo warning is displayed in the following format.

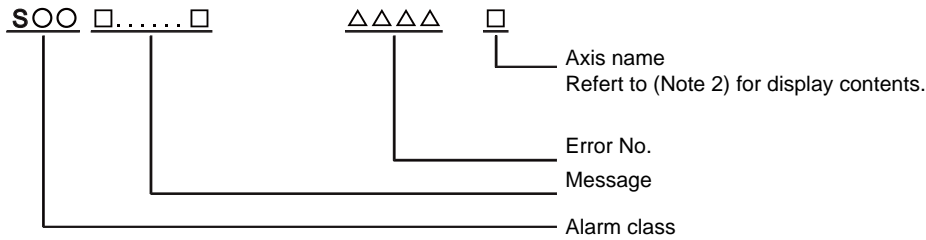

Alarm class	Message
S52	Servo warning

Error No. consists of four digits (0096 to). Servo warnings are explained in ascending order of the error No. The four digits on the left part of each warning indicate the error No.

(Note 1) For the details of servo warnings, refer to your drive unit's instruction manual.

(Note 2) The axis names are shown as followings.

[For M700UM]

- NC axis: axis name
- PLC axis : "P1", "P2", "P3", "P4", "P5", "P6"
- Spindle : "S1", "S2", "S3", "S4"

[For M700BM]

<For Special display unit or MELDAS screen>

- NC axis: axis name
- PLC axis : axis name is displayed with small letters when axis name is set.
"1", "2", "3", "4", "5", "6" when axis name is not set.
- Spindle : "S", "T", "M", "N"

<For Mitsubishi HMI screen>

- NC axis: axis name
- PLC axis : "P1", "P2", "P3", "P4", "P5", "P6"
- Spindle : "S1", "S2", "S3", "S4"

Drive unit warnings

0096 Scale feedback error

Details

An excessive difference in feedback amount was detected between the main side detector and the MPI scale in MPI scale absolute position detection system.
- Reset method: Automatically reset once the cause of the warning is removed.

0097 Scale offset error

Details

An error was detected in the offset data that is read at the NC power-ON in MPI scale absolute position detection system.

009B Detec cnv: Mag pole shift warn

Details

The difference between the magnetic pole position after the phase Z has been passed (magnetic pole shift amount:SV028) and the initially detected position is excessive in the built-in motor's incremental control system. The magnetic pole is controlled by the initial detection value.
- Reset method: Automatically reset once the cause of the warning is removed.

009E Abs pos dtc: Rev count error

Details

An error was detected in the revolution counter data of the absolute position detector. The accuracy of absolute position is not guaranteed.
- Reset method: Automatically reset once the cause of the warning is removed.

009F Battery voltage drop**Details**

The battery voltage to be supplied to the absolute position detector is dropping.

00A3 In initial setup of ABS posn.**Details**

This warning is detected until the axis reaches the reference position during the initial setup of the distance-coded reference check function. This warning turns OFF after the axis has reached the position, thus set the value displayed on the drive monitor to the parameter.

This warning is detected during the initial setup of MBA405W. This warning turns OFF after the initial setup is completed by having the axis pass the Z-phase of MBA405W and turning the NC power ON again.

- Reset method: Automatically reset once the cause of the warning is removed.

00A4 Dual signal warning**Details**

An input was detected in the signal related to the dual signal.

- Reset method: Automatically reset once the cause of the warning is removed.

00A6 Fan stop warning**Details**

A cooling fan in the drive unit stopped.

- Reset method: Automatically reset once the cause of the warning is removed.

00E0 Over regeneration warning**Details**

Over-regeneration detection level exceeded 80%.

- Reset method: Automatically reset once the cause of the warning is removed.

00E1 Overload warning**Details**

A level of 80% of the Overload 1 alarm state was detected.

- Reset method: Automatically reset once the cause of the warning is removed.

00E4 Set parameter warning**Details**

An incorrect set value was detected among the parameters send from the NC in the normal operation.

- Reset method: Automatically reset once the cause of the warning is removed.

00E6 Control axis detach warning**Details**

A control axis is being detached. (State display)

- Reset method: Automatically reset once the cause of the warning is removed.

00E7 In NC emergency stop state**Details**

In NC emergency stop. (State display)

- Stop method: Deceleration stop enabled

- Reset method: Automatically reset once the cause of the warning is removed.

00E8-00EF Power supply warning**Details**

The power supply unit detected a warning. The error details are different according to the connected power supply unit.

Refer to "Power supply warning".

- Stop method: - (EA: Deceleration stop enabled)

- Reset method: Automatically reset once the cause of the warning is removed.

Power supply warnings

00E9 Instant pwr interrupt warning

Details

The power was momentarily interrupted.

00EA In external EMG stop state

Details

External emergency stop signal was input.
 - Reset method: Automatically reset once the cause of the warning is removed.

00EB Pw sply: Over regenerat warn

Details

Over-regeneration detection level exceeded 80%.
 - Reset method: Automatically reset once the cause of the warning is removed.

00EE Pw sply: Fan stop warning

Details

A cooling fan built in the power supply unit stopped.
 - Reset method: Automatically reset once the cause of the warning is removed.

00EF Pw sply: Option unit warning

Details

A warning is detected in the power backup unit (power supply option unit).
 Check the LED display on the power backup unit to identify what alarm is occurring to the unit. Refer to the using drive unit instruction manual for details.

1.3.6 Safety Function Warnings (S53)

S53 Safety function warning (Warning) (Axis name)

Details

Warnings are displayed in four digits(hexadecimal).

Display format of warnings

000_

(a)

The hexadecimal numbers (a) indicates the following details.

bit0 : Both of STO1 and STO2 are input.

- Axis type : All types
- During release of axis : Enable

bit1 : STO1 is input.

- Axis type : All types
- During release of axis : Enable

bit2 : STO2 is input.

- Axis type : All types
- During release of axis : Enable

1.4 MCP Alarms (Y)

(Note 1) "Y02" alarms are displayed as "Y02 System alarm" with the error number. Error number is the four digit number displayed after error name (start from 0050). "Y02" alarms are listed in ascending order in this manual.

(Note 2) "Y20" alarms are displayed as "Y20 Safety observation alarm" with the error number. Error number is the four digit number displayed after error name (start from 0001). "Y20" alarms are listed in ascending order in this manual.

(Note 3) "Y21" warnings are displayed as "Y21 Safety observation warning" with the error number. Error number is the four digit number displayed after error name (start from 0001). "Y21" warnings are listed in ascending order in this manual.

(Note 4) "Y51" warnings are displayed as "Y51 Parameter error" with the error number. Error number is the four digit number displayed after error name (start from 0001). "Y51" warnings are listed in ascending order in this manual.

Y02 System alm: Process time over 0050

Details

System alarm: Process time is over.

Remedy

The software or hardware may be damaged.
Contact the service center.

(Note) When two or more "Y02 System alarms" occur at the same time, only the alarm which has occurred first is displayed.

Y02 SV commu er: CRC error 1 0051 0000

Details

A communication error has occurred between controller and drive unit.

Remedy

- Take measures against noise.
- Check for any failure of the communication cable connectors between controller and drive unit or between two drive units.
- Check for any failure of the communication cables between controller and drive unit or between two drive units.
- A drive unit may be faulty. Take a note of the 7-segment LED contents of each drive unit and contact the Service Center.
- Update the drive unit software version.

(Note) When two or more "Y02 System alarms" occur at the same time, only the alarm which has occurred first is displayed.

Y02 SV commu er: CRC error 2 0051 0001

Details

A communication error has occurred between controller and drive unit.

Remedy

- Take measures against noise.
- Check for any failure of the communication cable connectors between controller and drive unit or between two drive units.
- Check for any failure of the communication cables between controller and drive unit or between two drive units.
- A drive unit may be faulty. Take a note of the 7-segment LED contents of each drive unit and contact the Service Center.
- Update the drive unit software version.

(Note) When two or more "Y02 System alarms" occur at the same time, only the alarm which has occurred first is displayed.

Y02 SV commu er: Recv timing err 0051 0002

Details

A communication error has occurred between controller and drive unit.

Remedy

- Take measures against noise.
- Check for any failure of the communication cable connectors between controller and drive unit or between two drive units.
- Check for any failure of the communication cables between controller and drive unit or between two drive units.
- A drive unit may be faulty. Take a note of the 7-segment LED contents of each drive unit and contact the Service Center.
- Update the drive unit software version.

(Note) When two or more "Y02 System alarms" occur at the same time, only the alarm which has occurred first is displayed.

Y02 SV commu er: Data ID error 0051 xy03

Details

A communication error has occurred between controller and drive unit.

x: Channel No. (0 to)

y: Drive unit rotary switch No. (0 to)

Remedy

- Take measures against noise.
- Check for any failure of the communication cable connectors between controller and drive unit or between two drive units.
- Check for any failure of the communication cables between controller and drive unit or between two drive units.
- A drive unit may be faulty. Take a note of the 7-segment LED contents of each drive unit and contact the Service Center.
- Update the drive unit software version.

(Note) When two or more "Y02 System alarms" occur at the same time, only the alarm which has occurred first is displayed.

Y02 SV commu er: Recv frame No. 0051 xy04

Details

A communication error has occurred between controller and drive unit.

x: Channel No. (from 0)

y: Drive unit rotary switch No. (from 0)

Remedy

- Take measures against noise.
- Check for any failure of the communication cable connectors between controller and drive unit or between two drive units.
- Check for any failure of the communication cables between controller and drive unit or between two drive units.
- A drive unit may be faulty. Take a note of the 7-segment LED contents of each drive unit and contact the Service Center.
- Update the drive unit software version.

(Note) When two or more "Y02 System alarms" occur at the same time, only the alarm which has occurred first is displayed.

Y02 SV commu er: Commu error 0051 x005

Details

A communication error has occurred between controller and drive unit.

x: Channel No. (from 0)

Remedy

- Take measures against noise.
- Check for any failure of the communication cable connectors between controller and drive unit or between two drive units.
- Check for any failure of the communication cables between controller and drive unit or between two drive units.
- A drive unit may be faulty. Take a note of the 7-segment LED contents of each drive unit and contact the Service Center.
- Update the drive unit software version.

(Note) When two or more "Y02 System alarms" occur at the same time, only the alarm which has occurred first is displayed.

Y02 SV commu er: Connect error 0051 x006**Details**

A communication error has occurred between controller and drive unit.
x: Channel No. (from 0)

Remedy

- Take measures against noise.
- Check for any failure of the communication cable connectors between controller and drive unit or between two drive units.
- Check for any failure of the communication cables between controller and drive unit or between two drive units.
- A drive unit may be faulty. Take a note of the 7-segment LED contents of each drive unit and contact the Service Center.
- Update the drive unit software version.

(Note) When two or more "Y02 System alarms" occur at the same time, only the alarm which has occurred first is displayed.

Y02 SV commu er : Init commu error 0051 xy20**Details**

A communication error has occurred between controller and drive unit.
A drive unit stopped due to transition failure from initial communication to runtime.
x: Channel No. (from 0)
y: Drive unit rotary switch No. (from 0)

Remedy

- Take measures against noise.
- Check for any failure of the communication cable connectors between controller and drive unit or between two drive units.
- Check for any failure of the communication cables between controller and drive unit or between two drive units.
- A drive unit may be faulty. Take a note of the 7-segment LED contents of each drive unit and contact the Service Center.
- Update the drive unit software version.

(Note) When two or more "Y02 System alarms" occur at the same time, only the alarm which has occurred first is displayed.

Y02 SV commu er: Node detect error 0051 xy30**Details**

A communication error has occurred between controller and drive unit.
No response from drive unit to the request from NC when setting network configuration.
x: Channel No. (from 0)
y: Station No. (from 0)

Remedy

- Take measures against noise.
- Check for any failure of the communication cable connectors between controller and drive unit or between two drive units.
- Check for any failure of the communication cables between controller and drive unit or between two drive units.
- A drive unit may be faulty. Take a note of the 7-segment LED contents of each drive unit and contact the Service Center.
- Update the drive unit software version.

(Note) When two or more "Y02 System alarms" occur at the same time, only the alarm which has occurred first is displayed.

Y02 SV communication error: Communication mode not supported 0051 xy31**Details**

A communication error has occurred between controller and drive unit.
 Drive unit's software version doesn't support the communication mode that the controller requires.
 x: Channel No. (from 0)
 y: Station No. (from 0)

Remedy

- Take measures against noise.
- Check for any failure of the communication cable connectors between controller and drive unit or between two drive units.
- Check for any failure of the communication cables between controller and drive unit or between two drive units.
- A drive unit may be faulty. Take a note of the 7-segment LED contents of each drive unit and contact the Service Center.
- Update the drive unit software version.

(Note) When two or more "Y02 System alarms" occur at the same time, only the alarm which has occurred first is displayed.

Y02 System alarm 0052 0001**Details**

Transfer to buffer is not properly done in servo communication.

Remedy

Software/ hardware may have a fault.
 Contact service center.

(Note) When two or more "Y02 System alarms 0051" alarms occur at the same time, only the alarm which occurs first is displayed.

Y03 Drive unit unequipped axis name**Details**

The drive unit is not correctly connected.
 Alphabet (axis name): Servo axis drive unit not mounted
 1 to 4: PLC axis drive unit not mounted
 S: No.1 spindle drive unit not mounted
 T: No.2 spindle drive unit not mounted
 M: No.3 spindle drive unit not mounted
 N: No.4 spindle drive unit not mounted

Remedy

- Check the drive unit mounting state.
- Check the end of the cable wiring.
 - Check for any broken wires.
 - Check the connector insertion.
 - The drive unit input power has not been ON.
 - The drive unit axis No. switch is illegal.

Y05 Initial parameter error**Details**

There is a problem in the value set for the number of axes or the number of part systems.

Remedy

Correct the value set for the following corresponding parameters:
 "#1001 SYS_ON (System validation setup)",
 "#1002 axisno (Number of axes)",
 "#1039 spinno (Number of spindles)", etc.

Y06 mcp_no setting error 0001**Details**

There is a skipped number in the channels.

Remedy

Check the values set for the following parameters.
 "#1021 mcp_no (Drive unit I/F channel No. (servo))"
 "#3031 smcp_no (Drive unit I/F channel No. (spindle))"

Y06 mcp_no setting error 0002**Details**

There is a duplicate setting for random layout.

Remedy

Check the values set for the following parameters.

"#1021 mcp_no (Drive unit I/F channel No. (servo))"

"#3031 smcp_no (Drive unit I/F channel No. (spindle))"

Y06 mcp_no setting error 0003**Details**

The drive unit fixed setting "0000" and random layout setting "*****" are both set.

Remedy

Check the values set for the following parameters.

"#1021 mcp_no (Drive unit I/F channel No. (servo))"

"#3031 smcp_no (Drive unit I/F channel No. (spindle))"

Y06 mcp_no setting error 0004**Details**

The spindle/C axis "#1021 mcp_no (Drive unit I/F channel No. (servo))" and "#3031 smcp_no (Drive unit I/F channel No. (spindle))" are not set to the same values.

Remedy

Check the values set for the following parameters.

"#1021 mcp_no (Drive unit I/F channel No. (servo))"

"#3031 smcp_no (Drive unit I/F channel No. (spindle))"

Y06 mcp_no setting error 0005**Details**

A random layout has been set while "#1154 pdoor" has been set to "1" in two-part system.

Remedy

Check the values set for the following parameters.

"#1021 mcp_no (Drive unit I/F channel No. (servo))"

"#3031 smcp_no (Drive unit I/F channel No. (spindle))"

Y06 mcp_no setting error 0006**Details**

The channel No. parameter is not within the setting range.

Remedy

Check the values set for the following parameters.

"#1021 mcp_no (Drive unit I/F channel No. (servo))"

"#3031 smcp_no (Drive unit I/F channel No. (spindle))"

Y07 Too many axes connected 00xy

Details

The number of axes connected to each channel exceeds the maximum number of connectable axes. The exceeded number of axes per channel is displayed as alarm No.

- x: Exceeded number of axes at drive unit interface channel 2 (0 to F)
- y: Exceeded number of axes at drive unit interface channel 1 (0 to F)

This alarm also occurs when the drive unit is connected only with the 2nd channel without connecting with the 1st channel.

Remedy

Remove connected axes from the channel whose alarm No. is other than '0' for the number displayed as the alarm No. Keep the number of connected axes to or less than the maximum that can be connected.

(Note 1) The number of axes is limited per each drive unit interface channel.

(Note 2) The maximum numbers of connectable axes per channel differ depending on the setting of "#11012 16 axes for 1ch (connecting 16 axes for 1ch.)."

The maximum numbers of connectable axes per channel are as follows: eight axes when "0" is set and sixteen axes when "2" is set for "#11012 16 axes for 1ch".

(Note 3) If this alarm occurs, the alarm 'Y03 Message: Drive unit unequipped' will not occur.

(Note 4) This alarm is displayed taking precedence over the alarm 'Y08 Too many drive units connected' and 'Y09 Too many axisno connected'.

Y08 Too many drive units connected 00xy

Details

The number of drive units connected to each channel exceeds 8. The exceeded number of drive units per channel is displayed as alarm No.

- x: Exceeded number of drive units at drive unit interface channel 2 (0 to F)
- y: Exceeded number of drive units at drive unit interface channel 1 (0 to F)

Remedy

Remove drive units from the channel whose alarm No. is other than "0" for the number displayed as the alarm No. Keep the number of connected drive units to 8 or less.

(Note 1) The drive unit is not counted when all the axes connected to it are invalid.

(Note 2) If this alarm occurs, the alarm "Y03 Message: Drive unit unequipped" will not occur.

(Note 3) The alarm "Y07 Too many axes connected" and "Y09 Too many axisno connected" are displayed taking precedence over this alarm.

Y09 Too many axisno connected 00xy

Details

The No. of the axis (drive unit's rotary switch No.) connected to each channel is bigger than the No. allowed.

If the axis No. of each channel is bigger than the No. allowed, "1" is displayed for the alarm No.

- x: "1" when the axis No. at drive unit interface channel 2 is too big
- y: "1" when the axis No. at drive unit interface channel 1 is too big

Remedy

For the channel whose alarm No. is "1", keep the axis No. (drive unit's rotary switch No.) not bigger than the No. allowed.

(Note 1) The axis No. is limited per each drive unit interface channel.

(Note 2) The numbers of connectable axes differ depending on the setting of "#11012 16 axes for 1ch (connecting 16 axes for 1ch.)."

The numbers of connectable axes per channel are as follows: 0 to 7 when "0" and 0 to F when "2" are set for "#11012 16 axes for 1ch".

(Note 3) If this alarm occurs, the alarm "Y03 Message: Drive unit unequipped" will not occur.

(Note 4) This alarm is displayed taking precedence over the alarm "Y08 Too many drive units connected".

(Note 5) The alarm "Y07 Too many axes connected" is displayed taking precedence over this alarm.

Y11 Node Detect Err 8002-8300 xy00**Details**

Drive unit does not respond to the request from NC when the NC is turned ON.
 Error No. shows the No. of communication phase at which the response stopped.
 x: Channel No. (0 or later)
 y: Station No. with the error (0 or later)

Remedy

The communication error may be caused by the drive unit software version that does not correspond to the NC software version. Check the drive unit software version.
 This alarm is canceled after the NC restarts.
 When the alarm is not canceled, write down the alarm No. and contact service center.

Y12 No commu. with axis drv unit**Details**

Although the high-speed synchronous tapping option is valid, the connected drive unit doesn't support the option.

Remedy

Replace the drive unit with that supports the option.

Y13 No commu. with sp drv unit**Details**

Although the high-speed synchronous tapping option is valid, the connected drive unit doesn't support the option.

Remedy

Replace the drive unit with that supports the option.

Y14 Comm btwn drives not ready**Details**

Communication between drive units failed to be ready within a specified time.

Remedy

- There may be a faulty connection of drive units.
- Check if any of drive units is broken.

Y20 Parameter compare error 0001 (Axis name)**Details**

The speed monitoring parameter in the NC does not correspond to the parameter transmitted to the drive unit.
 The name of the axis with an error is displayed.

Remedy

The NC or the servo drive unit may be damaged.
 Contact the service center.

Y20 Sfty obsrvation: Cmd spd err 0002 (Axis name)**Details**

The speed exceeding the speed set with the parameter was commanded during the speed monitoring mode.
 The name of the axis with an error is displayed.

Remedy

Check the speed monitoring parameter and the sequence program.
 Restart the NC.

Y20 Sfty obsrvation: FB pos err 0003 (Axis name)**Details**

The commanded position, transmitted to the servo drive unit from NC, is totally different from the feedback position received from the servo drive unit during the speed monitoring mode.
 The name of the axis with an error is displayed.

Remedy

The NC or the servo drive unit may be damaged.
 Contact the service center.

Y20 Sfty obsrvation: FB speed err 0004 (Axis name)**Details**

Actual rotation speed of the motor is exceeding the speed that has been set with speed monitoring parameter during the speed monitoring mode.
The name of the axis with an error is displayed.

Remedy

Correct the speed observation parameter and the sequence program.
Restart the NC.

Y20 Door signal: Input mismatch 0005 Door No.**Details**

Door state signals on the NC side and the drive side do not match. It may be caused by the followings:

- Cable disconnection
- Damaged door switch
- Damaged NC or servo drive unit

Remedy

Check the cable.
Check the door switch.
Restart the NC.

Y20 No speed observation mode in door open 0006 Door No.**Details**

The door open state was detected when the speed monitoring mode was invalid.
The causes may be same as the ones for 0005 (Door signal: Input mismatch). Also the sequence program may not be correct.

Remedy

Correct the sequence program.
Restart the NC.

Y20 Speed obsv: Para incompatible 0007 (Axis name)**Details**

Two speed monitoring parameters are not matched at the rising edge of the "speed monitor mode" signal.
The name of the axis with an error is displayed.

Remedy

Correct the relevant parameters so that the two speed monitoring parameters match.
Restart the NC.

Y20 Contactor welding detected 0008 Contactor No.**Details**

Contactor welding was detected.
Displays the bit corresponding to the No. of the abnormal contactor.
Some contactors take a while to be shutdown after the servo ready is turned OFF, and the servo ready was turned ON in the meantime.

Remedy

- Make sure that contactor's auxiliary B contact signal is output correctly to the device set on "#1330 MC_dp1(Contactor weld detection device 1)" and "#1331 MC_dp2(Contactor weld detection device 2)".
- If welding, replace the contactor.
- Restart the NC.

Y20 No spec: Safety observation 0009**Details**

"#2313 SV113 SSF8/bitF (ssc SLS (Safely Limited Speed) function)" and "#13229 SP229 SFNC9/bitF (ssc SLS (Safely Limited Speed) function)" are set for a system with no safety observation option.

Remedy

Disable "#2313 SV113 SSF8/bitF (ssc SLS (Safely Limited Speed) function)" and "#13229 SP229 SFNC9/bitF (ssc SLS (Safely Limited Speed) function)".
Then, restart the NC.

Y20 SDIO connector input volt err 0010**Details**

24VDC power is not supplied to SDIO connector correctly. (SDIO 4A pin supply voltage was dropped to 16V or less, or 1ms or more instant power interrupt was detected.)

In this case, "Pw sply:Inst pw interpt(DC24V)" alarm occurs because the contactor control output signal cannot be controlled.

This state remains until restarting the NC even if the cause of the alarm has been removed.

Remedy

Check the wiring. Supply 24VDC power to the SDIO connector.

Restart the NC.

Y20 Device setting illegal 0011**Details**

- The device set in "#1353 MC_ct1 (Contactor shutoff output 1 device)" does not exist.

- The device set in "#1353 MC_ct1 (Contactor shutoff output 1 device)" is used as an output device in PLC program.

Remedy

- In "#1353 MC_ct1 (Contactor shutoff output 1 device)", set the device to which a remote I/O is connected. Use the device to control the contactor.

- Confirm that the devices set by "#1353 MC_ct1 (Contactor shutoff output 1 device)" are not used as an output device in PLC program.

Y20 Contactor operation abnormal 0012 Contactor No.**Details**

Contactor's operation is not following the NC's commands.

Displays the No. of the abnormal contactor.

Remedy

- Check and correct "#1353 MC_ct1 (Contactor shutoff output 1 device)" setting.

- Check the wiring for contactor shutoff.

- Check for contactor's welding.

Y20 STO function operation illegal 0013**Details**

The drive unit's STO function has failed to work properly.

Remedy

Check if the setting parameter #1353 MC_ct1 for the contactor shutoff output device is correctly set.

Check the wiring of STO cable.

Y20 STO function illegal at pwr ON 0014**Details**

The motor power has not been shut down with the STO function when the NC power was turned ON.

Remedy

Check the wiring of STO cable.

When the power of the drive system is OFF, turn the power ON.

Y20 Safety signal compare error 0020 (Device No.)**Details**

A mismatch between safety signals which were input to the NC Control unit and those which were input to the Drive unit was detected.

The following causes are assumed:

- Cable is disconnected.

- Sensor is broken.

Alarm No. shows the device No. which has the error. ("0024" indicates the device No. X24.)

When two or more signals are detected for errors, the No. shows the first detected signal.

Remedy

Check the wiring.

Y20 Safety signal para setting err 0027**Details**

#2180 S_DIN, #2188 S_SigIn, #3140 S_DINSp, and #3145 S_SigInSP are not correctly set.

Remedy

Correct the parameter settings.

Y20 Sfty obsrvtion para memory err 0031**Details**

The safety observation parameters and the data for checking the parameters are inconsistent.

Remedy

- Check all the safety observation parameters.
- Reset parameters.
- Restore the backup data, in case the parameters or the data for checking the parameters are broken.

Y20 Constant spd obs para set err 0038**Details**

- The constant speed observation is enabled to the axis with a door signal input.
- The value of constant speed observation is smaller than observation speed 1 to 8.

The name of the axis with an error is displayed.

Remedy

- The constant speed observation has not to be enabled to the axis with a door signal input.
- Set the faster speed than the setting value of observation speed 1 to 8 for the constant speed observation.

Y20 Constant speed observation err 0039**Details**

- The safety observation is not enabled for the axis for which the constant observation is enabled.

The name of the axis with an error is displayed.

Remedy

- Check if the following parameters are correctly set: #2196/bit 0 (constant speed observation), #2313/bit F (SLS (Safely Limited Speed) function), #3164/bit 0(constant speed observation), #13229/bit F (SLS (Safely Limited Speed) function).

Y21 Speed obsv signal: Speed over 0001 (Axis name)**Details**

The speed exceeds the safety speed limit when the "speed monitor mode" signal is ON.
The name of the axis with an error is displayed.

Remedy

Decelerate the speed to reset the warning and start the speed monitor.

Y51 Parameter G0tL illegal 0001**Details**

The time constant has not been set or exceeded the setting range.

Remedy

Correct "#2004 G0tL (G0 time constant (linear))".

Y51 Parameter G1tL illegal 0002**Details**

The time constant has not been set or exceeded the setting range.

Remedy

Correct "#2007 G1tL (G1 time constant (linear))".

Y51 Parameter G0t1 illegal 0003**Details**

The time constant has not been set or exceeded the setting range.

Remedy

Correct "#2005 G0t1 (G0 time constant (primary delay) / Second-step time constant for soft acceleration/deceleration)".

Y51 Parameter G1t1 illegal 0004**Details**

The time constant has not been set or exceeded the setting range.

Remedy

Correct "#2008 G1t1 (G1 time constant (primary delay)/Second-step time constant for soft acceleration/deceleration)".

Y51 Parameter grid space illegal 0009**Details**

The grid space is illegal.

Remedy

Correct "#2029 grspc(Grid interval)".

Y51 Parameter stapt1-4 illegal 0012**Details**

The time constant has not been set or exceeded the setting range.

Remedy

Correct the parameters from "#3017 stapt1(Tap time constant (Gear: 00))" to "#3020 stapt4(Tap time constant (Gear: 11))".

Y51 Secondary axis No. illegal 0014**Details**

In the axis synchronization, parameter settings for secondary axis differs from that of primary axis.

Remedy

- Correct the "#1068 slavno (secondary axis number)" setting.

Y51 Parameter skip_tL illegal 0015**Details**

The time constant has exceeded the setting range.

Remedy

Correct "#2102 skip_tL (Skip time constant linear)".

Y51 Parameter skip_t1 illegal 0016**Details**

The time constant has exceeded the setting range.

Remedy

Correct "#2103 skip_t1 (Skip time constant primary delay / Second-step time constant for soft acceleration/deceleration)".

Y51 Parameter G0bdcc illegal 0017**Details**

"#1205 G0bdcc (Acceleration and deceleration before G0 interpolation)" for the 2nd part system is set to acceleration/deceleration before G0 interpolation.

Remedy

Correct "#1205 G0bdcc (Acceleration and deceleration before G0 interpolation)".

Y51 OMR-II parameter error 0018**Details**

An illegal setting was found in the OMR-II-related parameters. OMR-II has been disabled.

Remedy

Correct the related parameter settings.

Y51 PLC indexing stroke length err 0019

Details

"#12804 aux_tleng (Linear axis stroke length)" has not been set or exceeded the setting range while the linear axis equal indexing is enabled for the PLC indexing axis.

Remedy

Correct "#12804 aux_tleng (Linear axis stroke length)".

Y51 No hi-accu acc/dec t-const ext 0020

Details

There is no expansion option for the high-accuracy acceleration/deceleration time constant.

Remedy

Set "#1207 G1btL (Time constant)" to a value within the setting range with no expansion specification for the extended high-accuracy time constant.

Y51 Var lost motion comp illegal 0021

Details

Variable lost motion compensation is requested while the function is out of specifications.

Remedy

- Check the specification.
- Change to the servo drive compatible with the variable lost motion compensation.
- When the variable lost motion compensation is not used, set "#12400 ValLMC(variable lost motion compensation) to OFF.

Y51 Parameter JHtL illegal 0026

Details

The time constant is not set or exceeded the setting range.

Remedy

Correct "#2616 JHtL (Jog/handle time constant)".

Y51 Parameter JHt1 illegal 0027

Details

The time constant is not set or exceeded the setting range.

Remedy

Correct "#2617 JHt1(Jog/handle time constant (primary delay) / Second-step time constant for soft acceleration/deceleration)".

Y51 Values of PC1/PC2 too large 0101

Details

The PC1 and PC2 settings for the rotary axis are too large.

Remedy

Correct "#2201 SV001 PC1 (Motor side gear ratio)" and "#2202 SV002 PC2 (Machine side gear ratio)".

Y90 No spindle signal 0001-0007

Details

There is an error in the spindle encoder signal.

The data transmission to the drive unit is stopped when this error occurs.

Remedy

Check the spindle encoder's feedback cable and the encoder.

1.5 System Alarms (Z)

(Note) "Z31"alarms are displayed as "Z31 DataServer error"with the error number. Error number is the four digit number displayed after error name(start from 0001). "Z31"alarms are listed in ascending order in this manual.

Z20 Power ON again

Details

A parameter is set witch will be enabled after the power is turned ON.

Remedy

Turn the power ON again.

Z31 Socket open error(socket) 0001

Details

Socket open error (socket)

Remedy

Set the parameter then turn the power OFF and ON again.

Z31 Socket bind error(bind) 0002

Details

Socket bind error (bind)

Remedy

Set the parameter then turn the power OFF and ON again.

Z31 Connection wait queue error(listen) 0003

Details

Connection wait queue error (listen)

Remedy

Set the parameter then turn the power OFF and ON again.

Z31 Connection request error(accept) 0004

Details

Connection request error (accept)

Z31 Data rcv error(socket error) 0005

Details

Data receive error (socket error)

Z31 Data rcv error(data error) 0006

Details

Data receive error (data error)

Z31 Data send error(socket error) 0007

Details

Data send error (socket error)

Z31 Data send error(data error) 0008

Details

Data send error (data error)

Z31 Socket close error(close) 000A

Details

Socket close error (close)

Remedy

Set the parameter then turn the power OFF and ON again.

Z35 Direct Socket connection error 0001 0001**Details**

- socket() error
- Connection has failed.

Remedy

- Check the connection of the network cables, and check for broken wires and a failure of the network connection devices such as hub.

Z35 Direct Socket connection error 0001 0002**Details**

- bind() error
- An invalid socket was specified.
 - The address is not available or in operation.
 - Socket is already bound.

Remedy

- Check the connection of the network cables, and check for broken wires and a failure of the network connection devices such as hub.

Z35 Direct Socket connection error 0001 0003**Details**

- listen() error
- An invalid socket was specified.
 - Cannot connect.

Remedy

- Check the connection of the network cables, and check for broken wires and a failure of the network connection devices such as hub.

Z35 Direct Socket connection error 0001 0004**Details**

- accept() error
- Connection has failed.

Remedy

- Check the connection of the network cables, and check for broken wires and a failure of the network connection devices such as hub.

Z35 Direct Socket connection error 0001 0005**Details**

- close() error
- Socket close has failed.

Remedy

- Check the connection of the network cables, and check for broken wires and a failure of the network connection devices such as hub.

Z35 Direct Socket connection error 0001 0006**Details**

- Number of client is over.
- Multiple clients attempted a connection.

Remedy

- When using the Direct Socket communication I/F, connect up to one client.

Z35 Direct Socket receive error 0002 0001**Details**

- recv() error
- Receiving data from a client has failed.

Remedy

- Check the connection of the network cables, and check for broken wires and a failure of the network connection devices such as hub.

Z35 Direct Socket receive error 0002 0002**Details**

Data error/disconnected

- Received data size differs from the size registered in the header of the packet received from the client.

Remedy

- Check the connection of the network cables, and check for broken wires and a failure of the network connection devices such as hub.
- Check the send data from the client.

Z35 Direct Socket send error 0003 0001**Details**

send() error

- Sending data to a client has failed.

Remedy

- Check the connection of the network cables, and check for broken wires and a failure of the network connection devices such as hub.

Z35 Direct Socket send error 0003 0002**Details**

Data error/disconnected

- Sending data to a client has failed.

Remedy

- Check the connection of the network cables, and check for broken wires and a failure of the network connection devices such as hub.
- Check that socket communication is enabled for the client.

Z35 Direct Socket timeout error 0004**Details**

There was no response from client computers, and a timeout error occurred.

Remedy

- Check the connection of the network cables, and check for broken wires and a failure of the network connection devices such as hub.

Z35 Direct Socket comm OFF 0005**Details**

The direct Socket communication I/F is OFF.

Remedy

- Check the parameter "#11051 Direct Socket OFF".

Z40 Format mismatch**Details**

"#1052 MemVal (No. of common variables shared in part system designation)", formatted at "0", was set to "1".

Remedy

- Reset "#1052 MemVal (No. of common variables shared in part system designation)" to "0" or format and restart.

Z51 E2PROM error 000X

Details

- Formatting of machine tool builder macro program area has not been successfully completed.
- Machine tool builder macro program has not been successfully written into FROM.

[Type]

- Z51 E2PROM error 0001: Open error
- Z51 E2PROM error 0002: Erase error
- Z51 E2PROM error 0003: Write error
- Z51 E2PROM error 0004: Verify error

Remedy

- Format the area again.
- Write the program into FROM again.

If the alarm is not cleared, hardware may be broken. Contact service center.

Z52 Battery fault 000x

Details

The voltage of the battery in the NC control unit has dropped. (The battery used to save the internal data.)

- 0001: Battery warning
- 0002: Battery detecting circuit error
- 0003: Battery alarm

(Note)The display of "Z52 battery fault 0001" can be removed by resetting. However, the warning state will not be cleared until the battery is replaced.

Remedy

- Replace the battery of the NC control unit.
- Check for any disconnection of the battery cable.
- After fixing the battery's fault, check the machining program.

Z53 overheat

Details

The controller or operation board temperature has risen above the designated value.

(Note)Temperature warning

When an overheat alarm is detected, the alarm is displayed and the overheat signal is output simultaneously. Automatic operation will be continued, while restarting after resetting or stopping with M02/M30 is not possible. (Restarting after block stop or feed hold is possible.) The alarm will be cleared and the overheat signal will turn OFF when the temperature drops below the specified temperature.

Z53 overheat 000x
[000x]

- 0001: The temperature in the control unit is high.

The ambient temperature must be lowered immediately when a "Z53 overheat" alarm occurs. However, if the machining needs to be continued, set "0" for the following parameter. Then the alarm will be invalidated.

Remedy

- Cooling measures are required.
- Turn OFF the controller power, or lower the temperature with a cooler, etc.

Z55 RIO communication stop**Details**

An error occurs in the communication between the control unit and remote I/O unit.

Disconnection of a cable

Fault in remote I/O unit

Fault of power supply to remote I/O unit

The alarm and the I/O unit No. is displayed when an error occurs in the communication between the control unit and remote I/O unit.

The remote I/O unit No. is displayed in eight digits. Two digits (in hexadecimal) are used for each board and part system.

[Display format of remote I/O unit No.]

Z55 RIO communication stop
 (a) (b) (c) (d)(e) (f) (g) (h)

(a)(b): Remote I/O 2nd part system communication interrupted station

(c)(d): Remote I/O 1st part system communication interrupted station

(e)(f): Remote I/O 3rd part system communication interrupted station

(g)(h): Board connection remote I/O communication interrupted station

(a)(b) indicates the following station in hexadecimal.

bit0: RIO (0th station)

bit1: RIO (first station)

bit2: RIO (second station)

bit3: RIO (third station)

bit4: RIO (fourth station)

bit5: RIO (fifth station)

bit6: RIO (sixth station)

bit7: RIO (seventh station)

This also applies for the remote I/O 1st part system communication interrupted station, remote I/O 3rd part system communication interrupted station and board connection remote I/O communication interrupted station.

Remedy

- Check and replace the cables.
- Replace the remote I/O unit.
- Check the power supply (existence of supply and voltage).

Z57 System warning**Details**

Program memory capacity has been set over the value that can be formatted.

An expansion device/expansion cassette has not mounted after formatting.

The mounted expansion device/expansion cassette is different from the one that was mounted at formatting.

Remedy

Check the followings.

- Program memory capacity
- Mounting of an expansion device/expansion cassette
- APLC release option

Z58 ROM write not completed**Details**

A machine tool builder macro program has not been written to FROM after being registered/ edited/ copied/ condensed/ merged/ the number changed/ deleted.

Remedy

- Write the machine tool builder macro program to FROM.

The program does not need to be written to FROM unless the editing operations and so on need to be valid after the NC power OFF.

Z59 Acc/dec time cnst too large**Details**

Acceleration and deceleration time constants are too large.

(This alarm is output at the same time as "T02 0206".)

Remedy

- Set the larger value for "#1206 G1bF(Maximum speed)".
- Set the smaller value for "#1207 G1btL(Time constant)".
- Set the lower feedrate.

Z60 Fieldbus communication error n1 n2 n3 n4

Details

A communication error has occurred on the Fieldbus communication with HN571/HN573/HN575.

[n1 :Shows state of the master channel (shown in hexadecimal number)]

00 :Offline In initializing

40 :Stop Cutting I/O communication

80 :Clear Resetting output data of each slave by sending 0 data.

C0 :In operation I/O In I/O communication

[n2 :Shows error state (shown in hexadecimal number)]

bit0 :Control error Parameter error

bit1 :Auto clear error Communication with all the slave channels was cut because a communication with one slave channel had an error.

bit2 :Non exchange error Slave channel with communication error is found.

bit3 :Fatal error The communication cannot be continued because severe network failure exists.

bit4 :Event error Short-circuit was found on the network.

bit5 :Not ready CNC communication is not ready.

bit6 :Time out error Time out was detected in communication with each channel.

bit7 :Not used

[n3 :Shows error No. (shown in hexadecimal number)]

- Error in master channel (when remote address with an error is FF (hexadecimal number))

0 :No error Operating normally

32 :No USR_INT Damage in HN571. Replace HN571.

33 :No global data field

34 :No FDL-task

35 :No PLC-task

37 :Master parameter incorrect

39 :Slave parameter incorrect

3C :Data offset exceeding allowable set value received. Check the configuration setting.

3D :Slave data send range overlap

3E :Slave data receive range overlap

3F :Not set data hand shake Damage in HN571. Replace HN571.

40 :RAM range exceeded

41 :Slave parameter data set illegal

CA :No segment

D4 :Data base read illegal Download the configuration data again.

D5 :Operating system illegal Damage in HN571. Replace HN571.

DC :Watch dog error

DD :Hand shake mode No data communication by 0

DE :Master auto clear mode When setting auto clear mode, the auto clear mode was performed because one slave was not able to connect in run time.

- Error in slave channel (when remote address with an error is other than FF (hexadecimal number))

Check the configuration of slave channel in which error has occurred. Check if there is any short-circuit in wire to bus.

2 :Station overflow reported

3 :Station stopped responding to master command

9 :No slave required responding data

11 :No station respond

12 :No master to logical token ring

15 :Illegal parameter requested

[n4 : Shows slave No. where communication error has occurred. (shown in hexadecimal number)]

'FF' means an error in master channel.

Z64 Valid term soon to be expired xx

Details

The valid term will be expired in less than a week. Remaining valid term is xx days.

Remedy

- Obtain a decryption code from the machine tool builder and input it in the NC, then turn the power ON again.

Z65 Valid term has been expired

Details

The valid term has been expired with no decryption code input.

Remedy

- Obtain a decryption code from the machine tool builder and input it in the NC, then turn the power ON again.

Z67 CC-Link communication error**Details**

A communication error occurred during CC-Link communication using CC-Link unit.

Remedy

- Refer to "List of Messages" in CC-Link (Master/Slave) Specification manual (BNP-C3039-214).

Z68 CC-Link unconnected**Details**

A cable between CC-Link unit and a device is disconnected or broken.

Remedy

- Connect the cable.
- Check for any broken cables.

Z69 External link error 2**Details**

A FROM/TO instruction was used while the MELSEC-Q interface expansion module is not installed.

Remedy

Install the MELSEC-Q interface expansion module.

Z69 External link error 3**Details**

A negative value was set for an I/O No. in the FROM/TO instruction.

Remedy

Correct the I/O No.

Z69 External link error 4**Details**

A negative value was set for transfer size in the FROM/TO instruction.

Remedy

Correct the transfer size.

Z69 External link error 5**Details**

The number of FROM/TO instructions within one scan has exceeded 50.

Remedy

Correct the user PLC (ladder sequence) so that the number of FROM/TO instructions per scan is 50 or less.

Z69 External link error 6**Details**

The access to the buffer memory by the FROM/TO instruction has exceeded 12K words per scan.

Remedy

Correct the user PLC (ladder sequence) so that the buffer memory access by the FROM/TO instruction won't exceed 12K words per scan. (The total size of FROM/TO is up to 12K words.)

Z69 External link error 7**Details**

A FROM/TO instruction was used in high-speed processing.

Remedy

Delete the FROM/TO instruction from high-speed processing.

Z69 External link error 8**Details**

The bit device number designated in the FROM/TO instruction is not a multiple of 16.

Remedy

Correct the bit device number designated in the FROM/TO instruction to be a multiple of 16.

Z69 External link error 9

Details

With a FROM/TO instruction, a value out of the address range (negative value, or 0x8000 or over) was set as the head address of the buffer memory.

Remedy

Correct the head address of the buffer memory.

Z69 External link error 10

Details

An alarm occurred in the MELSEC module mounted on the extension base.

Remedy

Check for any disconnection of the MELSEC module and the cables on the extension base. Then turn the CNC's power ON again.

Z69 External link error 11

Details

The I/O No. designated in the FROM/TO instruction is different from the mounted location of the intelligent function module on the extension base (the module's I/O No.).

Remedy

Correct the I/O No. Then turn the CNC's power ON again.

Z87 System link error

Details

System link error is occurred.

Remedy

Contact your machine builder.

Z88 PLC address conflict (R register No.) (R register state bit)

Details

The address for R register conflicts between PLC and special display unit.
R register No. is displayed in five digits (decimal).

[When R register No.: 0/R register No. state bit:0]
R register No. in conflict is not specified.
- Stop method: Reset signal

[When R register No.: other than 0/R register No. state bit:1]
R register No. in conflict can be specified.
The head R register No. including the right access from PLC is displayed.
With the user PLC, check the usage of four continuous R register numbers from displayed R register No.

(Example) When "Z88 PLC address conflict 29868 1" is displayed,
Check if data are written into R29868,R29869,R29870,R29871.
- Stop method: Reset signal

1.6 Absolute Position Detection System Alarms (Z7*)

(Note 1) "Z70" alarms are displayed as "Z70 Abs data error" with the error number. Error number is the four digit number displayed after error name (start from 0001). "Z70" alarms are listed in ascending order in this manual.

(Note 2) "Z71" alarms are displayed as "Z71 Abs encoder failure" with the error number. Error number is the four digit number displayed after error name (start from 0001). "Z71" alarms are listed in ascending order in this manual.

Z70 Abs posn base set incomplete 0001 (Axis name)

Details

Zero point initialization is incomplete. Otherwise, the spindle was removed.

Remedy

Complete zero point initialization.

(Note) To release alarm "Z70 Abs data error", enter the parameter data output when establishing the absolute position and turn ON the power again. For the rotary axis, however, the alarm cannot be released by entering the parameter data.

- Zero point initialization: Required

Z70 Absolute position lost 0002 (Axis name)

Details

The absolute position basic point data saved in the NC has been damaged.

Remedy

Set the parameters. If the basic point data is not restored by setting the parameters, perform zero point initialization.

(Note) To release alarm "Z70 Abs data error", enter the parameter data output when establishing the absolute position and turn ON the power again. For the rotary axis, however, the alarm cannot be released by entering the parameter data.

- Zero point initialization: (Required)

Z70 Abs posn param changed 0003 (Axis name)

Details

Any of the parameters for absolute position detection has been changed.

#1003 iunit
#1016 iout
#1017 rot
#1018 ccw
#1040 M_inch
#2049 type

Remedy

Correct the parameter settings. Then turn the power ON again and perform zero point initialization.

(Note) To release alarm "Z70 Abs data error", enter the parameter data output when establishing the absolute position and turn ON the power again. For the rotary axis, however, the alarm cannot be released by entering the parameter data.

- Zero point initialization: Required

Z70 Abs posn initial set illegal 0004 (Axis name)

Details

The zero point initialization point is not at the grid position.

Remedy

Perform the zero point initialization again.

(Note) To release alarm "Z70 Abs data error", enter the parameter data output when establishing the absolute position and turn ON the power again. For the rotary axis, however, the alarm cannot be released by entering the parameter data.

- Zero point initialization: Required

Z70 Abs posn param restored 0005 (Axis name)

Details

The data has been restored by inputting the parameters during the alarm No.0002.

Remedy

Turn the power ON again to start the operation.

(Note) To release alarm "Z70 Abs data error", enter the parameter data output when establishing the absolute position and turn ON the power again. For the rotary axis, however, the alarm cannot be released by entering the parameter data.

- Zero point initialization: Not required

Z70 Abs data error 0006 (axis name)

Details

Deviation of the servo axis with scale when the power is OFF exceeds the set value in "#2051 check (Check)".

Remedy

Search for the factor which led the deviation of the servo axis at the power OFF.

- Zero point initialization: Not required
- Alarm reset when power is turned OFF: -
- Servo alarm No.: -

Z70 Excessive posn detected when Power supply on 0007 (axis name)

Detail

The machine positions at the power ON and OFF differ more than the value set in "#2051 check". This alarm occurs mainly by the following causes.

1. The machine position has changed.
2. Detector problem.

Remedy

- Initial setting for the zero point.
- If this alarm repeatedly occurs, check if the machine position has changed when turning the power OFF.
- Replace the detector.

Z70 Abs posn data lost 0080 (Axis name)

Details

The absolute position data has been lost. An error of the multi-rotation counter data in the detector and so on may be the cause.

Remedy

Replace the detector and complete zero point initialization.

(Note) To release alarm "Z70 Abs data error", enter the parameter data output when establishing the absolute position and turn ON the power again. For the rotary axis, however, the alarm cannot be released by entering the parameter data.

- Zero point initialization: Required
- Servo alarm No.: (9E)etc.

Z70 Abs posn error(servo alm 25) 0101 (Axis name)

Details

The servo alarm No. 25 was displayed and the power was turned ON again.

Remedy

Perform zero point initialization again.

(Note) To release alarm "Z70 Abs data error", enter the parameter data output when establishing the absolute position and turn ON the power again. For the rotary axis, however, the alarm cannot be released by entering the parameter data.

- Zero point initialization: Required
- Servo alarm No.: -25

Z70 Abs posn error(servo alm E3) 0106 (Axis name)

Details

The servo alarm No. E3 was displayed and the power was turned ON again.

Remedy

Perform zero point initialization again.

(Note) To release alarm "Z70 Abs data error", enter the parameter data output when establishing the absolute position and turn ON the power again. For the rotary axis, however, the alarm cannot be released by entering the parameter data.

- Zero point initialization: Required
- Servo alarm No.: (E3)

Z71 AbsEncoder:Backup voltage drop 0001 (Axis name)

Details

Backup voltage in the absolute position detector dropped.

Remedy

Replace the battery, check the cable connections, and check the detector. Turn the power ON again and perform zero point initialization.

- Zero point initialization: Required
- Alarm reset when power is turned OFF: -(Z70-0101 is displayed after the power is turned ON again.)
- Servo alarm No.: 25

Z71 AbsEncoder: Commu error 0003 (Axis name)

Details

Communication with the absolute position detector has been disabled.

Remedy

Check and replace the cables, card or detector. Turn the power ON again and perform zero point initialization.

- Zero point initialization: (Required) only when the detector has been replaced.
- Alarm reset when power is turned OFF: Reset
- Servo alarm No.: 91

Z71 AbsEncoder: Abs data changed 0004 (Axis name)

Details

Absolute position data has been changed at the absolute position establishment.

Remedy

Check and replace the cables, card or detector. Turn the power ON again and perform zero point initialization.

- Zero point initialization: (Required) only when the detector has been replaced.
- Alarm reset when power is turned OFF: Reset
- Servo alarm No.: 93

Z71 AbsEncoder: Serial data error 0005 (Axis name)

Details

An error of the serial data was found in the absolute position detector.

Remedy

Check and replace the cables, card or detector. Turn the power ON again and perform zero point initialization.

- Zero point initialization: (Required) only when the detector has been replaced.
- Alarm reset when power is turned OFF: Reset
- Servo alarm No.: 92

Z71 AbsEncoder: Abs/inc posn diffr 0006 (Axis name)

Details

Servo alarm E3
Absolute position counter warning

Remedy

Operation is possible until the power is turned OFF.

- Zero point initialization: (Required) after the power is turned ON again.
- Alarm reset when power is turned OFF: Reset (Z70-0106 is displayed after the power is turned ON again.)
- Servo alarm No.: E3

Z71 AbsEncoder: Initial communication error 0007 (Axis name)**Details**

Initial communication with the absolute position detector is not possible.

Remedy

Check and replace the cables, card or detector. Turn the power ON again and perform zero point initialization.

- Zero point initialization: (Required) only when the detector has been replaced.
- Alarm reset when power is turned OFF: Reset
- Servo alarm No.: 18

Z72 Message: Position check error (Axis name)**Details**

An error is detected at the comparison of detector's absolute position and controller coordinate values in the absolute position detection system.

Remedy**Z73 Battery for abs data fault 0001****Details**

Low backup battery
Servo alarm 9F
Low battery voltage

Remedy

This is displayed when the battery voltage is low or the cable has been damaged.

The absolute position initialization is not required.

Even after the servo alarm 9F is canceled, this alarm will continue to be displayed until NC reset is entered.

(Note) When this alarm has occurred, do not turn OFF the drive unit power in order to protect the absolute position data. Replace the battery with the drive unit power ON.

1.7 Distance-coded Reference Scale Errors (Z8*)

Z80 Basic position lost 0001

Details

The basic point data saved in the NC has been damaged.

Remedy

- Set the parameters. If the basic point data is not restored by setting the parameters, perform zero point initialization.

Z80 Basic position restore 0002

Details

The basic point data has been restored by setting the parameters.

Remedy

- Turn the power ON again to start the operation.

Z80 No spec: Distance-coded scale 0003

Details

The distance-coded reference scale has been set available although this function is out of the specifications.

Remedy

- Check the specifications.
- If you do not use this function, correct the detector type with the servo parameter.

Z81 R-pos adjustment data lost 0001

Details

Reference position adjustment value data saved in the NC has been damaged.

Remedy

- Set the parameter. If the data is not restored by setting the parameter, establish the reference position again.

Z81 R-pos adjustment data restored 0002

Details

After the 'Z81 R-pos adjustment data lost 0001', the data has been recovered by setting the parameter.

Remedy

- Establish the reference position to start the operation.

1.8 Emergency Stop Alarms (EMG)

EMG Emergency stop PLC

Details

The user PLC has entered the emergency stop state during the sequence process.

Remedy

- Investigate and remove the cause of the user PLC emergency stop.

EMG Emergency stop EXIN

Details

The "emergency stop" signal is significant (open).

Remedy

- Cancel the "emergency stop" signal.
- Check for any broken wires.

EMG Emergency stop SRV

Details

An alarm occurred in the servo system causing an emergency stop.

Remedy

- Investigate and remove the cause of the servo alarm.

EMG Emergency stop STOP

Details

The user PLC (ladder sequence) is not running.

Remedy

- Check the setting of the control unit rotary switch CS2. Correct it if set to "1".
- Check the [RUN/SP] (run/stop) switch on the PLC edit file save screen (onboard function). Turn it OFF if ON.

EMG Emergency stop SPIN

Details

Spindle drive unit is not mounted.

Remedy

- Cancel the causes of the other emergency stop.
- Check the "emergency stop" signal input in the spindle drive unit.

EMG Emergency stop PC_H

Details

Failure in the high-speed PC processing abnormal

Remedy

- Correct the sequence program. (To stop monitoring the high-speed PC processing temporarily, set "1" in "#1219 aux03/bit1 (Stop high-speed PC monitoring function)". Disable the monitoring function only as a temporary measure.)

EMG Emergency stop PARA

Details

Setting of the door open II fixed device is illegal.

Setting of the parameters for dog signal random assignment is illegal.

Remedy

- Correct the "#1155 DOOR_m" and "#1156 DOOR_s" settings. (When the door open II fixed device is not used, set "#1155 DOOR_m" and "#1156 DOOR_s" to "100".)
- Correct the "#2073 zrn_dog (Origin dog Random assignment device)", "#2074 H/W_OT+ (H/W OT+ Random assignment device)", "#2075 H/W_OT- (H/W OT- Random assignment device)" and "#1226 aux10/bit5 (Arbitrary allocation of dog signal)" settings.

EMG Emergency stop LINK**Details**

An emergency stop occurs when the FROM/TO instruction is not executed within 500ms.

Remedy

- Execute the FROM/TO instruction one or more times every 500ms.

The time in which no interrupt request is issued from MELSEC is measured and stored in the following R registers:

R10190: Current timeout counter

R10191: Maximum timeout counter after power ON

R10192: Maximum timeout counter after system is started up (this is backed up)

Details

MELSEC is in error and reset states.

Remedy

- Check the MELSEC states.

Details

The contents of MELSEC-specific code area in buffer memory have been damaged.

Remedy

- Check the MELSEC states.

Details

PLC serial link communication has stopped.

(Note) When "WAIT" is entered in the PLC serial link, only the preparation sequence has been established before the communication stops. It is supposed that the settings of the serial link parameters "#1902 Din size" and "#1903 Dout size" are incorrect or the "#1909 Tout (ini)" set-time is too short in basic specification parameters.

Remedy

- Check the CC-Link card wiring and the external sequencer transmission.
- Check the link communication errors shown on the diagnostic screen.
- Correct the settings of the serial link parameters in basic specification parameters.

EMG Emergency stop WAIT**Details**

The preparation sequence is not sent from the master station. Otherwise, the contents of the received preparation sequence are inconsistent with those of the parameters, so that the usual sequence cannot be started.

(Note) When "LINK" is also entered for the PLC serial link, refer to "Note" in the section, "LINK".

Remedy

- Check that the CC-Link card switch setting and wiring as well as the external sequencer transmission are normal.
- Check the diagnostic screen for link communication errors.

EMG Emergency stop XTEN**Details**

The CC-Link card is operating incorrectly.

Switch/parameter settings for the CC-Link card are incorrect.

Remedy

- Replace the CC-Link card.
- Correct the switch/parameter settings for the CC-Link card.

EMG Emergency stop LAD**Details**

The sequence program has an illegal code.

Remedy

- Correct any illegal device Nos. or constants in the sequence program.

EMG Emergency stop CVIN

Details

The "emergency stop" signal for power supply is significant (open) because the external emergency stop function for power supply is enabled.

Remedy

- Cancel the "emergency stop" signal.
- Check for any broken wires.
- Make sure that NC reset 1 signal, NC rest 2 signal, and reset & rewind signal are all OFF. (All part systems must be OFF on a multi-part system machine.)

EMG Emergency stop MCT

Details

The contactor shutoff test is being executed.

Remedy

- The emergency stop is reset automatically after the contactor shutoff is confirmed.
- If the contactor shutoff is not confirmed within 5 seconds after the "contactor shutoff test" signal has been input, the "contactor welding detected" alarm occurs and the emergency stop status remains.
- Make sure that the contactor's auxiliary B contact signal is correctly output to the device that is set in "#1330 MC_dp1" and "#1331 MC_dp2" (Contactor weld detection device 1 and 2), and then turn the power ON again.

EMG Emergency stop IPWD

Details

The data backup for power failure might not have been executed successfully at the previous power failure.

Remedy

- If this message appears frequently, the power supply may be deteriorated. Contact the service center.

EMG Emergency stop SUIN

Details

The emergency stop input signal (M0) is OFF in the NC/PLC safety circuit.

Remedy

- Check the conditions for turning ON the emergency stop input signal.
- Check for any broken wires.

EMG Emergency stop STP2

Details

Sequence programs stopped in CNC.

Remedy

- Correct the rotary switch 1 (on the right) of the control unit if set to "1".

EMG Emergency stop MULT

Details

An error related to Q bus or Qr bus occurred.

Remedy

- Refer to the error No. that follows the message "A01 Multi CPU error" to take a remedy.

EMG Emergency stop LINE

Details

The emergency stop line of the drive unit connecting cable is OFF.

Remedy

- Check the connection of terminal connector.
- Check the connection of the drive unit connecting cable.
- An alarm has occurred to the safety observation unit.

1.9 Computer Link Errors (L)

(Note) "L01" alarms are displayed as "L01 Computer link error" with the error number. Error number is the four digit number displayed after error name (start from 0002). "L01" alarms are listed in ascending order in this manual.

L01 Serial port being used 0002

Details

Serial port has already been opened or cannot be used.

Remedy

- Set the port not to shared by Anshin-net and so on.
- Correct the parameter settings for tape operation port.

L01 Timeout error 0004

Details

Communication ended with timeout.

(CNC has a 248-byte receive buffer. The time during which CNC receives 248 bytes exceeds the 'TIME-OUT' value set in the I/O device parameter.

Remedy

- Set a greater timeout value in the input/output device parameter.
- Check the software in HOST and make sure that the HOST transmits data in response to DC1(data request) from CNC.
- Set '#9614 START CODE' to '0'.

L01 Host ER signal OFF 0010

Details

ER signal in HOST (or DR signal in CNC) is not turned ON.

Remedy

- Check for any disconnected cable.
- Check for any broke wire.
- Make sure that the HOST power is turned ON.

L01 Parity H error 0015

Details

Communication ended with parity H.

Remedy

- Check the software in HOST and make sure that the data to be transmitted to CNC is ISO code.

L01 Parity V error 0016

Details

Communication ended with parity V.

Remedy

- Correct the data to transmit to CNC.

L01 Overrun error 0017

Details

CNC received 10 bytes or more data from HOST in spite of DC3 (request to stop data transfer) transmission from CNC to the HOST, which terminated the communication.

CNC received 10 bytes or more data from HOST during the data transmission from CNC to the HOST.

Remedy

- Check the software in HOST and make sure that the HOST stops transmitting data within 10 bytes after receiving DC3.
- Correct the software in HOST not to transmit data such as a command or header to CNC during receiving a machining program.

1.10 User PLC Alarms (U)

U01 No user PLC - -

Details

PLC program is not input.

(Note 1) The number of PLC program steps displayed on the screen may not match the actual number of error occurrence steps because of the PLC program timing. Use this as a guideline of the occurrence place.

(Note 2) Emergency stop (EMG) will be applied.

Remedy

Download the PLC program with the format selected by the PLC environment selection parameters (bit selection "#51/bit4").

U10 Illegal PLC 0x0010 -

Details

PLC scan time error

The scan time is 1 second or longer.

(Note) The number of PLC program steps displayed on the screen may not match the actual number of error occurrence steps because of the PLC program timing. Use this as a guideline of the occurrence place.

Remedy

Edit the PLC program to make the size smaller.

U10 Illegal PLC 0x0040 -

Details

PLC program operation mode illegal

The downloaded PLC program is compatible with the designated mode.

(Note 1) The number of PLC program steps displayed on the screen may not match the actual number of error occurrence steps because of the PLC program timing. Use this as a guideline of the occurrence place.

(Note 2) Emergency stop (EMG) will be applied.

Remedy

Turn the power ON again or download the PLC program with the same format as at the power ON.

U10 Illegal PLC 0x0080 -

Details

GPPW ladder code error

(Note 1) The number of PLC program steps displayed on the screen may not match the actual number of error occurrence steps because of the PLC program timing. Use this as a guideline of the occurrence place.

(Note 2) Emergency stop (EMG) will be applied.

Remedy

Download the PLC program with a correct GPPW format.

U10 Illegal PLC 0x008x -

Details

PLC4B ladder code error

An illegal circuit was found in the PLC4B ladder.

bit1: PC medium-speed circuit illegal

bit2: PC high-speed circuit illegal

(Note 1) The number of PLC program steps displayed on the screen may not match the actual number of error occurrence steps because of the PLC program timing. Use this as a guideline of the occurrence place.

(Note 2) Emergency stop (EMG) will be applied.

Remedy

Download the correct PLC4B format PLC program.

U10 Illegal PLC 0x0400 Number of ladder steps**Details**

Software illegal interrupt

An abnormal stop occurred in the PLC program process due to an illegal code for software command.

(Note 1) The number of PLC program steps displayed on the screen may not match the actual number of error occurrence steps because of the PLC program timing. Use this as a guideline of the occurrence place.

(Note 2) Emergency stop (EMG) will be applied.

Remedy

Turn the power ON again.

If the error is not reset, download the correct PLC program.

U10 Illegal PLC 0x800x Number of PLC program steps**Details**

Software exception

An abnormal stop occurred in PLC program process due to a bus error, etc.

bit0: BIN command operation error

bit1: BCD command operation error

(Note) The number of PLC program steps displayed on the screen may not match the actual number of error occurrence steps because of the PLC program timing. Use this as a guideline of the occurrence place.

Remedy

Refer to the methods for using the BCD and BIN function commands.

Details

Software exception

An abnormal stop occurred in PLC program process due to a bus error, etc.

bit6: CALL/CALLS/RET command error

bit7: IRET command execution error

(Note 1) The number of PLC program steps displayed on the screen may not match the actual number of error occurrence steps because of the PLC program timing. Use this as a guideline of the occurrence place.

(Note 2) Emergency stop (EMG) is applied for bit6/7.

Remedy

Turn the power ON again.

If the error is not reset, download the correct PLC program.

U10 Illegal PLC 0x8Bxx Step No./register No.**Details**

Software exceptional interruption

An abnormal stop occurred in PLC program process due to a bus error, etc.

The setting of #6456 bit7 enables to change display contents of factors information when this alarm occurred.

0: Step number

1: Write R register number from PLC when an error occurred.

(Note 1) Step number will be advanced with several commands from the occurrence. The step No. can be a guide of the occurrence place.

Remedy

When this alarm occurred, step numbers and write R register numbers from PLC will be registered to the following R register.

R38: Step number (Low side)

R39: Step number (High side)

R40: Write R register number from PLC

This R register will not be updated until an alarm of same factors occurs.

In PLC program, check the usage of four continuous R register numbers from R register number registered in R40.

This alarm occurs also when the writing is simultaneously executed from the special display unit to the area within 8-bit boundary including R register to be written from PLC program.

Although the parameter #1261 bit0=1 enables to avoid the alarm, R register reviews to use separately the area within the 8-bit boundary in PLC program and the special display unit.

(Note 1) When parameter setting is #1261 bit0=1, the latest data writing is adopted.

U50 PLC stopped**Details**

The PLC program is stopped.

(Note) The number of PLC program steps displayed on the screen may not match the actual number of error occurrence steps because of the PLC program timing. Use this as a guideline of the occurrence place.

Remedy

Start the PLC program.

U55 PLC stopped / is not saved**Details**

The PLC program is stopped and not written into ROM.

(Note) The number of PLC program steps displayed on the screen may not match the actual number of error occurrence steps because of the PLC program timing. Use this as a guideline of the occurrence place.

Remedy

Write the PLC program into ROM.

U60 Ladder is not saved**Details**

The PLC program is not written into ROM.

(Note) The number of PLC program steps displayed on the screen may not match the actual number of error occurrence steps because of the PLC program timing. Use this as a guideline of the occurrence place.

Remedy

Write the PLC program into ROM.

1.11 Network Service Errors (N)

N001 Modem initial error

Details

An error occurred in the modem connection at the power ON.

Remedy

- Check the connection between the NC and modem, connection port and power supply to modem.

N002 Redial over

Details

- The number of redials exceeded due to the dial transmission failure.

Remedy

- Wait a while, and then dial again.

N003 TEL unconnect

Details

- The phone line is not connected.

Remedy

- Check for any disconnection in the modem's phone line.

N004 Net communication error

Details

- An error other than the above occurred during communication.

Remedy

- Note down how the error occurred and contact the service center.

N005 Invalid net communication

Details

- The modem connection port is being used for another function such as input/output.
- The modem connection port settings are incorrect.

Remedy

- Stop using the modem connection port with the other function, and then turn the power ON again.
- Correct the settings of the modem connection port.

N006 Received result of diagnosis

Details

- A diagnosis data file has been received.

Remedy

- Clear the message.

N007 Send data size over

Details

- A file larger than Anshin-net server capacity (64Kbyte) has been transmitted in machining data sharing.

Remedy

- Reduce the size of machining program file so that it won't exceed the capacity of Anshin-net server.

N008 No file on server

Details

- The file reception failed in machining data sharing because no file exists on Anshin-net server.

Remedy

- Confirm that a machining program file exists on Anshin-net server before receiving it.

N009 Password error**Details**

- The file reception failed in machining data sharing due to a wrong password.

Remedy

- Input the password again.

N010 Customer number error**Details**

- The file reception failed in machining data sharing due to a wrong customer number.

Remedy

- Input the customer number again.

N011 Storage capacity over**Details**

- The file reception failed in machining data sharing because the size of the file to be received is bigger than free space in the NC.

Remedy

- Ensure sufficient free space in the NC.

N012 File deletion error**Details**

- A file on Anshin-net server cannot be deleted in machining data sharing.

Remedy

- Confirm that the file exists on Anshin-net server.
- Note down how the error occurred and contact the service center.

1.12 Program Errors (P)

(Note) Program error messages are displayed in abbreviation on the screen.

P10 No. of simultaneous axes over

Details

The number of axis addresses commanded in a block exceeds the specifications.

Remedy

- Divide the alarm block command into two.
- Check the specifications.

P11 Illegal axis address

Details

The axis address commanded by the program does not match any of the ones set by the parameter.

Remedy

- Correct the axis names in the program.

P20 Division error

Details

The issued axis command cannot be divided by the command unit.

Remedy

- Correct the program.

P29 Not accept command

Details

The command has been issued when it is impossible.

- The normal line control command (G40.1, G41.1, G42.1) has been issued during the modal in which the normal line control is not acceptable.
- The command has been issued during the modal in which the 2-part system synchronous thread cutting is not acceptable.
- G118.2/G119.2 was commanded in one of the following mode.
Fixed cycle, macro interrupt, constant surface speed control
- G119.2 was commanded when M code of the spindle forward/reverse run command which is set in "#3028 sprcmm" was one of the followings;
M00/M01/M02/M30/M98/M99/M198
M code No. that commands to enable/disable the macro interrupt signal.

Remedy

- Correct the program.
- Correct the parameter settings.

P30 Parity H error

Details

The number of holes per character on the paper tape is even for EIA code and odd for ISO code.

Remedy

- Check the paper tape.
- Check the tape puncher and tape reader.

P31 Parity V error

Details

The number of characters per block on the paper tape is odd.

Remedy

- Make the number of characters per block on the paper tape even.
- Set the parameter parity V selection OFF.

P32 Illegal address**Details**

An address not listed in the specifications has been used.

Remedy

- Correct the program address.
- Correct the parameter settings.
- Check the specifications.

Details

The retract is commanded to the axis not intended for the tool retract and return.

Remedy

- Set "0" to "#2597 retract_axis" for the axis intended for the tool retract and return.

P33 Format error**Details**

- The command format in the program is not correct.
- More than two axes are specified at the chopping command.
- An invalid address is specified in the same block of chopping command.
- An address of other axis than chopping axis is commanded during a chopping mode.
- Another G code is commanded in the chopping(G81.1) command block.
- G81.1 is commanded although chopping function is out of the specifications.

Remedy

- Correct the program.

P34 Illegal G code**Details**

The commanded G code is not in the specifications.

An illegal G code was commanded during the coordinate rotation command.

Remedy

- Correct the G code address in the program.

Details

G51.2 or G50.2 was commanded when "#1501 polyax (Rotational tool axis number)" was set to "0".
G51.2 or G50.2 was commanded when the tool axis was set to the linear axis ("#1017 rot (Rotational axis)" is set to "0").

Remedy

- Correct the parameter settings.

Details

G81.1 is commanded during an operation not allowed the simultaneous use with the chopping.

An illegal G code is commanded during the chopping.

Remedy

- Correct the program.

P35 Setting value range over**Details**

The setting range for the addresses has been exceeded.

The program coordinates overflowed because commands to the linear type rotary axis accumulated in one direction.

Remedy

- Correct the program.

P36 Program end error**Details**

"EOR" has been read during tape and memory mode.

Remedy

- Enter the M02 and M30 command at the end of the program.
- Enter the M99 command at the end of the subprogram.

P37 O, N number zero**Details**

"0" has been specified for program or sequence No.

Remedy

- Designate program Nos. within a range from 1 to 99999999.
- Designate sequence Nos. within a range from 1 to 99999.

P38 No spec: Add. Op block skip**Details**

"/n" has been issued while the optional block skip addition is not in the specifications.

Remedy

- Check the specifications.

P39 No specifications**Details**

- A non-specified G code was commanded.
- The selected operation mode is out of specifications.

Remedy

- Check the specifications.

P40 Pre-read block error**Details**

The interference check is disabled due to an error in the pre-read block in tool radius compensation.

Remedy

- Correct the program.

P48 Restart pos return incomplete**Details**

A travel command was issued before the execution of the block that had been restart-searched.

Remedy

- Carry out program restart again.
Travel command cannot be executed before the execution of the block that has been restart-searched.

P49 Invalid restart search**Details**

- Restart search was attempted for the 3-dimensional circular interpolation.
- Restart search was attempted for the mixed control (cross axis control) command (G110).
- Restart search was attempted during the cylindrical interpolation, polar coordinate interpolation, or tool tip center control.
- Restart search was attempted from a block (G68.2) during the inclined surface machining mode or from the inclined surface machining mode cancel command block (G69).
- Restart search was attempted to the program after direct command mode.

Remedy

- Correct the program.
- Correct the restart search position.

P50 No spec: Inch/Metric change**Details**

Inch/Metric changeover (G20/G21) command was issued while the function is out of specifications.

Remedy

- Check the specifications.

P60 Compensation length over**Details**

The commanded movement distance is excessive (over 2^{31}).

Remedy

- Correct the command range for the axis address.

P61 No spec: Unidirectional posit.

Details

Unidirectional positioning (G60) was commanded while the function is out of specifications.

Remedy

- Check the specifications.

P62 No F command

Details

- No feed rate command has been issued.
- There is no F command in the cylindrical interpolation or polar coordinate interpolation immediately after the G95 mode is commanded.

Remedy

- The default movement modal command at power ON is G01. This causes the machine to move without a G01 command if a movement command is issued in the program, and an alarm results. Use an F command to specify the feed rate.
- Specify F with a thread lead command.

P63 No spec: High-speed machining

Details

High-speed machining cancel (G5P0) was commanded while the high-speed machining is out of specifications.

Remedy

- Check the specifications.

P65 No spec: High speed mode 3

Details

Remedy

- Check whether the specifications are provided for the high-speed mode III.

P70 Arc end point deviation large

Details

- There is an error in the arc start and end points as well as in the arc center.
- The difference of the involute curve through the start point and the end point is large.
- When arc was commanded, one of the two axes configuring the arc plane was a scaling valid axis.

Remedy

- Correct the numerical values of the addresses that specify the start and end points, arc center as well as the radius in the program.
- Correct the "+" and "-" directions of the address numerical values.
- Check for the scaling valid axis.

P71 Arc center error

Details

- An arc center cannot be obtained in R-specified circular interpolation.
- A curvature center of the involute curve cannot be obtained.

Remedy

- Correct the numerical values of the addresses in the program.
- Correct the start and end points if they are inside of the base circle for involute interpolation. When carrying out tool radius compensation, make sure that the start and end points after compensation will not be inside of the base circle for involute interpolation.
- Correct the start and end points if they are at an even distance from the center of the base circle for involute interpolation.

P72 No spec: Helical cutting

Details

A helical command has been issued though it is out of specifications.

Remedy

- Check whether the specifications are provided for the helical cutting.
- An Axis 3 command has been issued by the circular interpolation command. If there is no helical specification, move the linear axis to the next block.

P73 No spec: Spiral cutting**Details**

A spiral command was issued though it is out of specifications.

Remedy

- Issue the G02.1 and G03.1 commands for circular interpolation.
- Check whether the specifications are provided for the spiral cutting.

P74 Can't calculate 3DIM arc**Details**

The 3-dimension circular cannot be obtained because the end block was not specified during 3-dimension circular interpolation supplementary modal.

The 3-dimension circular cannot be obtained due to an interruption during 3-dimension circular interpolation supplementary modal.

Remedy

- Correct the program.

P75 3DIM arc illegal**Details**

An illegal G code was issued during 3-dimension circular interpolation modal.

Otherwise, 3-dimension circular interpolation command was issued during a modal for which a 3-dimension circular interpolation command cannot be issued.

Remedy

- Correct the program.

P76 No spec: 3DIM arc interpolat**Details**

G02.4/G03.4 was commanded though there is no 3-dimension circular interpolation specification.

Remedy

- Check the specifications.

P80 No spec: Hypoth ax interpolat**Details**

Hypothetical axis interpolation (G07) was commanded though it is out of specifications.

Remedy

- Check the specifications.

P90 No spec: Thread cutting**Details**

A thread cutting command was issued though it is out of specifications.

Remedy

- Check the specifications.

P91 No spec: Var lead threading**Details**

Variable lead thread cutting (G34) was commanded though it is out of specifications.

Remedy

- Check the specifications.

P93 Illegal pitch vaule**Details**

An illegal thread lead (thread pitch) was specified at the thread cutting command.

Remedy

- Correct the thread lead for the thread cutting command.

P100 No spec: Cylindric interpolat

Details

A cylindrical interpolation command was issued though it is out of specifications.

Remedy

- Check the specifications.

P110 Plane select during figure rot

Details

Plane selection (G17/G18/G19) was commanded during figure rotation.

Remedy

- Correct the machining program.

P111 Plane selected while coord rot

Details

Plane selection commands (G17, G18, G19) were issued during a coordinate rotation was being commanded.

Remedy

- Always command coordinate rotation cancel after the coordinate rotation command, and then issue a plane selection command.

P112 Plane selected while R compen

Details

- Plane selection commands (G17, G18, G19) were issued while tool radius compensation (G41, G42) and nose R compensation (G41, G42, G46) commands were being issued.
- Plane selection commands were issued after completing nose R compensation commands when there were no further axis movement commands after G40, and compensation has not been cancelled.

Remedy

- Issue plane selection commands after completing (axis movement commands issued after G40 cancel command) tool radius compensation and nose R compensation commands.

P113 Illegal plane select

Details

The circular command axis does not correspond to the selected plane.

Remedy

- Select a correct plane before issuing a circular command.

P120 No spec: Feed per rotation

Details

Feed per rotation (G95) was commanded though it is out of specifications.

Remedy

- Check the specifications.

P121 F0 command during arc modal

Details

F0 (F 1-digit feed) was commanded during the arc modal (G02/G03).

Remedy

- Correct the machining program.

P122 No spec: Auto corner override

Details

An auto corner override command (G62) was issued though it is out of specifications.

Remedy

- Check the specifications.
- Delete the G62 command from the program.

P123 No spec: High-accuracy control**Details**

High-accuracy control command was issued though it is out of specifications.

Remedy

- Check the specifications.

P124 No spec: Inverse time feed**Details**

- The inverse time option is not provided.

Remedy

- Check the specifications.

P125 G93 mode error**Details**

- The issued G code command is illegal during G93 mode.
- G93 command was issued during a modal for which inverse time feed cannot be performed.

Remedy

- Correct the program.

P126 Invalid cmdnd in high-accuracy**Details**

An illegal command was issued during high-accuracy control mode.

- G code group 13 command was issued during high-accuracy control mode.
- One of the following was commanded during high-accuracy control mode.
(1)Milling (2)Cylindrical interpolation (3)Pole coordinate interpolation

Remedy

- Correct the program.
- Select optimum acceleration/deceleration control while polar coordinate/ cylindrical interpolation or milling is commanded.

P127 No spec: SSS Control**Details**

The SSS control valid parameter has been set although there is no SSS control specification.

Remedy

- Check the specifications. Set "#8090 SSS ON" to "0" when there is no SSS control specification.

P130 2nd M function code illegal**Details**

The 2nd miscellaneous function address, commanded in the program, differs from the address set in the parameters.

Remedy

- Correct the 2nd miscellaneous function address in the program.

P131 No spec: Cnst surface ctrl G96**Details**

A constant surface speed control command (G96) was issued though it is out of specifications.

Remedy

- Check the specifications.
- Issue a rotation speed command (G97) instead of the constant surface speed control command (G96).

P132 Spindle rotation speed S=0**Details**

No spindle rotation speed command has been issued.

Remedy

- Correct the program.

P133 Illegal P-No. G96

Details

The illegal No. was specified for the constant surface speed control axis.

Remedy

- Correct the parameter settings and program that specify the constant surface speed control axis.

P134 G96 Clamp Err.

Details

The constant surface speed control command (G96) was issued without commanding the spindle speed clamp (G92/G50).

Remedy

- Press the reset key and carry out the remedy below.
- Check the program.
 - Issue the G92/G50 command before the G96 command.
 - Command the constant surface speed cancel (G97) to switch to the rotation speed command.

P140 No spec: Pos compen cmd

Details

The position compensation command (G45 to G48) is out of specifications.

Remedy

- Check the specifications.

P141 Pos compen during rotation

Details

Position compensation was commanded during the figure rotation or coordinate rotation command.

Remedy

- Correct the program.

P142 Pos compen invalid arc

Details

Position compensation cannot be executed with the issued arc command.

Remedy

- Correct the program.

P150 No spec: Nose R compensation

Details

- Tool radius compensation commands (G41 and G42) were issued though they are out of specifications.
- Nose R compensation commands (G41, G42, and G46) were issued though they are out of specifications.

Remedy

- Check the specifications.

P151 Radius compen during arc mode

Details

A compensation command (G40, G41, G42, G43, G44, or G46) has been issued in the arc modal (G02 or G03).

Remedy

- Issue the linear command (G01) or rapid traverse command (G00) in the compensation command block or cancel block.
(Set the modal to linear interpolation.)

P152 No intersection**Details**

- In interference block processing during execution of a tool radius compensation (G41 or G42) or nose R compensation (G41, G42, or G46) command, the intersection point after one block is skipped cannot be determined.
- The compensation amount cannot be calculated during the tool radius compensation for 5-axis machining (G41.2,G42.2).

Remedy

- Correct the program.

P153 Compensation interference**Details**

An interference error has occurred while the tool radius compensation command (G41 or G42) or nose R compensation command (G41, G42 or G46) was being executed.

Remedy

- Correct the program.

P154 No spec: 3D compensation**Details**

A three-dimensional compensation command was issued though it is out of specifications.

Remedy

- Check the specifications.

P155 Fixed cyc exec during compen**Details**

A fixed cycle command has been issued in the radius compensation mode.

Remedy

- Issue a radius compensation cancel command (G40) to cancel the radius compensation mode that has been applied since the fixed cycle command was issued.

P156 R compen direction not defined**Details**

A shift vector with undefined compensation direction was found at the start of G46 nose R compensation.

Remedy

- Change the vector to that which has the defined compensation direction.
- Change the tool to that which has a different tip point No.

P157 R compen direction changed**Details**

During G46 nose R compensation, the compensation direction is reversed.

Remedy

- Change the G command to that which allows the reversed compensation direction (G00, G28, G30, G33, or G53).
- Change the tool to that which has a different tip point No.
- Enable "#8106 G46 NO REV-ERR".

P158 Illegal tip point**Details**

An illegal tip point No. (other than 1 to 8) was found during G46 nose R compensation.

Remedy

- Correct the tip point No.

P159 C-CMP REMAINS

Details

One of the followings was commanded while the compensation has not been canceled (the compensation amount remained).

- (1) Automatic tool nose R compensation (G143)
- (2) Radius compensation (G145)
- (3) Plane selection (G17 to G19)
- (4) Skip (G31 or G31.1/G31.2/G31.3)
- (5) Fixed cycle for drilling (G81 to G89)
- (6) Compound type fixed cycle II (G74 to G76)

Remedy

- Cancel the compensation (with compensation amount "0") before commanding.
- Command the G00 move block before the block with a command among (1) to (6).

P160 G53 CMP. ERR

Details

- G53 was commanded during nose R compensation (by G41/G42/G46).
- G53 was commanded to the block where the nose R compensation mode is changed (with G40/G41/G42/G46).
- G53 was commanded while nose R compensation amount has not been cleared.

Remedy

- Correct the program.
- When issuing G53 after G40 command, move the compensation plane axis by G00/G01/G02/G03 command before issuing G53.

P161 No spec: 5ax tool R compensate

Details

Tool radius compensation for 5-axis machining is not included in the specifications.

Remedy

- Check the specifications.

P162 Disable Cmd in 5ax tool R comp

Details

A command (G or T command, etc) was issued during tool radius compensation for 5-axis machining, although it is disabled during the compensation.

Remedy

- Cancel the tool radius compensation for 5-axis machining.

P163 5 ax tool R comp is disable

Details

Tool radius compensation for 5-axis machining was commanded in a mode where the command is disabled.

Remedy

- Cancel the mode that disables the command.

P169 Tool offset amount zero

Details

The tool offset amount of the offset number(D ○○ , H ○○) commanded by the compensation commands(note) is zero.

(Note) Compensation commands are as follows:

Tool radius compensation (G41, G42, G41.2, G42.2) D command

Tool length compensation (G43,G44,G43.1, G43.4, G43.5) H command

Remedy

- Check the compensation amount of the offset number.
- Correct the program.

P170 No offset number**Details**

- No compensation No. (DOO, TOO or HOO) command was given when the radius compensation (G41, G42, G43 or G46) command was issued. Otherwise, the compensation No. is larger than the number of sets in the specifications.
- When setting the L system tool life management II, the tool group management program was executed with the tool life management disabled.

Remedy

- Add the compensation No. command to the compensation command block.
- Check the number of sets for the tool compensation Nos. and correct the compensation No. command to be within the number of sets.
- When setting the L system tool life management II ("#1096 T_Ltyp="2"), enable the tool life management ("#1103 T_Life="1") to execute a tool group management program.

P171 No spec:Comp input by prog G10**Details**

Compensation data input by program (G10) was commanded though it is out of specifications.

Remedy

- Check the specifications.

P172 G10 L number error**Details**

An address of G10 command is not correct.

Remedy

- Correct the address L No. of the G10 command.

P173 G10 P number error**Details**

The compensation No. at the G10 command is not within the permitted number of sets in the specifications.

Remedy

- Check the number of sets for the tool compensation Nos. and correct the address P designation to be within the number of sets.

P174 No spec:Comp input by prog G11**Details**

Compensation data input by program cancel (G11) was commanded though there is no specification of compensation data input by program.

Remedy

- Check the specifications.

P177 Tool life count active**Details**

Registration of tool life management data with G10 was attempted when the "usage data count valid" signal was ON.

Remedy

- The tool life management data cannot be registered during the usage data count. Turn the "usage data count valid" signal OFF.

P178 Tool life data entry over**Details**

The number of registration groups, total number of registered tools or the number of registrations per group exceeded the range in the specifications.

Remedy

- Correct the number of registrations.

P179 Illegal group No.

Details

- A duplicate group No. was found at the registration of the tool life management data with G10.
- A group No. that was not registered was designated during the T****99 command.
- An M code command, which must be issued as a single command, coexists in the same block as that of another M code command.
- The M code commands set in the same group exist in the same block.

Remedy

- Register the tool life data once for one group: commanding with a duplicate group No. is not allowed.
- Correct to the group No.

P180 No spec: Drilling cycle

Details

A fixed cycle command (G72 - G89) was issued though it is out of specifications.

Remedy

- Check the specifications.
- Correct the program.

P181 No spindle command (Tap cycle)

Details

Spindle rotation speed (S) has not been commanded in synchronous tapping.

Remedy

- Command the spindle rotation speed (S) in synchronous tapping.
- When "#8125 Check Scode in G84" is set to "1", enter the S command in the same block where the synchronous tapping command is issued.

P182 Synchronous tap error

Details

- Connection to the main spindle unit was not established.
- The synchronous tapping was attempted with the spindle not serially connected under the multiple-spindle control I.

Remedy

- Check connection to the main spindle.
- Check that the main spindle encoder exists.
- Set 1 to the parameter #3024 (sout).

P183 No pitch/thread number

Details

The pitch or number of threads has not been commanded in the tap cycle of a fixed cycle for drilling command.

Remedy

- Specify the pitch data and the number of threads by F or E command.

P184 Pitch/thread number error

Details

- The pitch or the number of threads per inch is illegal in the tap cycle of the fixed cycle for drilling command.
- The pitch is too small for the spindle rotation speed.
- The thread number is too large for the spindle rotation speed.

Remedy

- Correct the pitch or the number of threads per inch.

P185 No spec: Sync tapping cycle

Details

Synchronous tapping cycle (G84/G74) was commanded though it is out of specifications.

Remedy

- Check the specifications.

P186 Illegal S cmd in synchro tap**Details**

S command was issued during synchronous tapping modal.

Remedy

- Cancel the synchronous tapping before issuing the S command.

P190 No spec: Turning cycle**Details**

A lathe cutting cycle command was issued though it is out of specifications.

Remedy

- Check the specification.
- Delete the lathe cutting cycle command.

P191 Taper length error**Details**

In the lathe cutting cycle, the specified length of taper section is illegal.

Remedy

- Set the smaller radius value than the axis travel amount in the lathe cycle command.

P192 Chamfering error**Details**

Chamfering in the thread cutting cycle is illegal.

Remedy

- Set a chamfering amount not exceeding the cycle.

P200 No spec: MRC cycle**Details**

The compound type fixed cycle for turning machining I (G70 to G73) was commanded though it is out of specifications.

Remedy

- Check the specifications.

P201 Program error (MRC)**Details**

- The subprogram, called with a compound type fixed cycle for turning machining I command, has at least one of the following commands: reference position return command (G27, G28, G29, G30); thread cutting (G33, G34); fixed cycle skip-function (G31, G31.n).
- An arc command was found in the first movement block of the finished shape program in compound type fixed cycle for turning machining I.

Remedy

- Delete G27, G28, G29, G30, G31, G33, G34, and fixed cycle G codes from the subprogram called with the compound type fixed cycle for turning machining I commands (G70 to G73).
- Delete G02 and G03 from the first movement block of the finished shape program in compound type fixed cycle for turning machining I.

P202 Block over (MRC)**Details**

The number of blocks in the shape program of the compound type fixed cycle for turning machining I is over 50 or 200 (the maximum number differs according to the model).

Remedy

- Set a 50/200 or less value for the number of blocks in the shape program called by the compound type fixed cycle for turning machining I commands (G70 to G73). (The maximum number differs according to the model).

P203 D cmdnd figure error (MRC)

Details

A proper shape will not obtained by executing the shape program for the compound type fixed cycle for turning machining I (G70 to G73).

Remedy

- Correct the shape program for the compound type fixed cycle for turning machining I (G70 to G73).

P204 E cmdnd fixed cycle error

Details

A command value of the compound type fixed cycle for turning machining (G70 to G76) is illegal.

Remedy

- Correct the command value of the compound type fixed cycle for turning machining (G70 to G76).

P210 No spec: Pattern cycle

Details

A compound type fixed cycle for turning machining II (G74 to G76) command was commanded though it is out of specifications.

Remedy

- Check the specifications.

P220 No spec: Special fixed cycle

Details

There are no special fixed cycle specifications.

Remedy

- Check the specifications.

P221 No. of special fixed holes = 0

Details

"0" has been specified for the number of holes in special fixed cycle mode.

Remedy

- Correct the program.

P222 G36 angle error

Details

A G36 command specifies "0" for angle intervals.

Remedy

- Correct the program.

P223 G12/G13 radius error

Details

The radius value specified with a G12 or G13 command is below the compensation amount.

Remedy

- Correct the program.

P224 No spec: Circular (G12/G13)

Details

There are no circular cutting specifications.

Remedy

- Check the specifications.

P230 Subprogram nesting over**Details**

Over 8 times of subprogram calls have been done in succession from a subprogram.

- A M198 command was found in the program in the data server.
- The program in the IC card has been called more than once (the program in the IC card can be called only once during nested).

Remedy

- Correct the program so that the number of subprogram calls does not exceed 8 times.

P231 No sequence No.**Details**

The sequence No., commanded at the return from the subprogram or by GOTO in the subprogram call, was not set.

Remedy

- Specify the sequence Nos. in the call block of the subprogram.

P232 No program No.**Details**

- The machining program has not been found when the machining program is called.

- The file name of the program registered in IC card is not corresponding to O No.

Remedy

- Enter the machining program.
- Check the subprogram storage destination parameters.
- Ensure that the external device (including IC card) that contains the file is mounted.

P235 Program editing**Details**

Operation was attempted for the file under program editing.

Remedy

- Execute the program again after completion of program editing.

P240 No spec: Variable commands**Details**

A variable command (with #) was issued though it is out of specifications.

Remedy

- Check the specifications.

P241 No variable No.**Details**

The variable No. commanded is out of the range specified in the specifications.

Remedy

- Check the specifications.
- Correct the program variable No.

P242 = not defined at vrble set**Details**

The "=" sign has not been commanded when a variable is defined.

Remedy

- Designate the "=" sign in the variable definition of the program.

P243 Can't use variables**Details**

An invalid variable has been specified in the left or right side of an operation expression.

Remedy

- Correct the program.

P250 No spec: Figure rotation**Details**

Figure rotation (M98 I_J_P_H_L_) was commanded though it is out of specifications.

Remedy

- Check the specifications.

P251 Figure rotation overlapped**Details**

Figure rotation command was issued during figure rotation.

Remedy

- Correct the program.

P252 Coord rotate in fig. rotation**Details**

A coordinate rotation related command (G68, G69) was issued during figure rotation.

Remedy

- Correct the program.

P260 No spec: Coordinates rotation**Details**

A coordinate rotation command was issued though it is out of specifications.

Remedy

- Check the specifications.

P270 No spec: User macro**Details**

A macro specification was commanded though it is out of specifications.

Remedy

- Check the specifications.

P271 No spec: Macro interrupt**Details**

A macro interruption command has been issued though it is out of specifications.

Remedy

- Check the specifications.

P272 NC and macro texts in a block**Details**

An executable statement and a macro statement exist together in the same block.

Remedy

- Place the executable statement and macro statement in separate blocks in the program.

P273 Macro call nesting over**Details**

The number of macro call nests exceeded the limit imposed by the specifications.

Remedy

- Correct the program so that the macro calls do not exceed the limit imposed by the specifications.

P275 Macro argument over**Details**

The number of argument sets in the macro call argument type II has exceeded the limit.

Remedy

- Correct the program.

P276 Illegal G67 command**Details**

A G67 command was issued though it was not during the G66 command modal.

Remedy

- Correct the program.
- Issue G66 command before G67 command, which is a call cancel command.

P277 Macro alarm message**Details**

An alarm command has been issued in #3000.

Remedy

- Refer to the operator messages on the diagnosis screen.
- Refer to the instruction manual issued by the machine tool builder.

P280 Brackets [] nesting over**Details**

Over five times have the parentheses "[" or "]" been used in a single block.

Remedy

- Correct the program so that the number of "[" or "]" is five or less.

P281 Brackets [] not paired**Details**

A single block does not have the same number of commanded parentheses "[" as that of "]".

Remedy

- Correct the program so that "[" and "]" parentheses are paired up properly.

P282 Calculation impossible**Details**

The arithmetic formula is incorrect.

Remedy

- Correct the formula in the program.

P283 Divided by zero**Details**

The denominator of the division is zero.

Remedy

- Correct the program so that the denominator for division in the formula is not zero.

P288 IF EXCESS**Details**

Over ten times of IF statement nesting have been done.

Remedy

Correct the program so that the number of IF statement nesting does not exceed ten.

P289 IF-ENDIF MMC.**Details**

An IF statement is not ended with ENDIF.

THEN/ELSE has been commanded while there is no IF command.

Remedy

- Correct the program so that IF statements are ended with ENDIFs.
- Put IF[condition] before THEN/ELSE command.

P290 IF sentence error**Details**

There is an error in the "IF[<conditional>]GOTO(" statement.

Remedy

- Correct the program.

P291 WHILE sentence error**Details**

There is an error in the "WHILE[<conditional>]DO(-END(" statement.

Remedy

- Correct the program.

P292 SETVN sentence error**Details**

There is an error in the "SETVN(" statement when the variable name setting was made.

Remedy

- Correct the program.
- The number of characters in the variable name of the SETVN statement must be 7 or less.

P293 DO-END nesting over**Details**

The number of DO-END nesting levels in the "WHILE[<conditional>]DO(-END(" statement has exceeded 27.

Remedy

- Correct the program so that the nesting levels of the DO-END statement does not exceed 27.

P294 DO and END not paired**Details**

The DOs and ENDS are not paired off properly.

Remedy

- Correct the program so that the DOs and ENDS are paired off properly.

P295 WHILE/GOTO in tape**Details**

There is a WHILE or GOTO statement on the tape during tape operation.

Remedy

- Apply memory mode operation instead of tape mode that does not allow the execution of the program with a WHILE or GOTO statement.

P296 No address (macro)**Details**

A required address has not been specified in the user macro.

Remedy

- Correct the program.

P297 Address-A error**Details**

The user macro does not use address A as a variable.

Remedy

- Correct the program.

P298 G200-G202 cmdnd in tape**Details**

User macro G200, G201, or G202 was specified during tape or MDI mode.

Remedy

- Correct the program.

P300 Variable name illegal**Details**

The variable names have not been commanded properly.

Remedy

- Correct the variable names in the program.

P301 Variable name duplicated**Details**

A duplicate variable name was found.

Remedy

- Correct the program so that no duplicate name exists.

P310 Not use GMSTB macro code**Details**

G, M, S, T, or B macro code was called during fixed cycle.

Remedy

- Correct the program.
- Correct the parameter settings.

P350 No spec: Scaling command**Details**

The scaling command (G50, G51) was issued though it is out of specifications.

Remedy

- Check the specifications.

P360 No spec: Program mirror**Details**

A mirror image (G50.1 or G51.1) command has been issued though the programmable mirror image specifications are not provided.

Remedy

- Check the specifications.

P370 No spec: Facing t-post MR**Details**

The facing turret mirror image specifications are not provided.

Remedy

- Check the specifications.

P371 Facing t-post MR illegal**Details**

- Mirror image for facing tool posts was commanded to an axis in external mirror image or parameter mirror image.
- The commanded mirror image for facing tool posts enables the mirror image for a rotary axis.

Remedy

- Correct the program.
- Correct the parameter settings.

P380 No spec: Corner R/C**Details**

The corner R/C was issued though it is out of specifications.

Remedy

- Check the specifications.
- Delete the corner chamfering/corner rounding command in the program.

P381 No spec: Arc R/C**Details**

Corner chamfering II or corner rounding II was commanded in the arc interpolation block though it is out of specifications.

Remedy

- Check the specifications.

P382 No corner movement**Details**

The block next to corner chamfering/ corner rounding is not a travel command.

Remedy

- Replace the block succeeding the corner chamfering/ corner rounding command by G01 command.

P383 Corner movement short**Details**

The travel distance in the corner chamfering/corner rounding command was shorter than the value in the corner chamfering/corner rounding command.

Remedy

- Set the smaller value for the corner chamfering/corner rounding than the travel distance.

P384 Corner next movement short**Details**

The travel distance in the following block in the corner chamfering/corner rounding command was shorter than the value in the corner chamfering/corner rounding command.

Remedy

- Set the smaller value for the corner chamfering/corner rounding than the travel distance in the following block.

P385 Corner during G00/G33**Details**

A block with corner chamfering/corner rounding was given during G00 or G33 modal.

Remedy

- Correct the program.

P390 No spec: Geometric**Details**

A geometric command was issued though it is out of specifications.

Remedy

- Check the specifications.

P391 No spec: Geometric arc**Details**

There are no geometric IB specifications.

Remedy

- Check the specifications.

P392 Angle < 1 degree (GEOMT)**Details**

The angular difference between the geometric line and line is 1° or less.

Remedy

- Correct the geometric angle.

P393 Inc value in 2nd block (GEOMT)**Details**

The second geometric block has a command with an incremental value.

Remedy

- Issue a command with an absolute value in the second geometric block.

P394 No linear move command (GEOMT)**Details**

The second geometric block contains no linear command.

Remedy

- Issue the G01 command.

P395 Illegal address (GEOMT)**Details**

The geometric format is invalid.

Remedy

- Correct the program.

P396 Plane selected in GEOMT ctrl**Details**

A plane switching command was issued during geometric command processing.

Remedy

- Complete the plane switching command before geometric command processing.

P397 Arc error (GEOMT)**Details**

In geometric IB, the circular arc end point does not contact or cross the next block start point.

Remedy

- Correct the geometric circular arc command and the preceding and following commands.

P398 No spec: Geometric1B**Details**

A geometric command was issued though the geometric IB specifications are not provided.

Remedy

- Check the specifications.

P411 Illegal modal G111**Details**

- G111 was issued during milling mode.
- G111 was issued during nose R compensation mode.
- G111 was issued during constant surface speed.
- G111 was issued during mixed control (cross axis control).
- G111 was issued during fixed cycle.
- G111 was issued during polar coordinate interpolation.
- G111 was issued during cylindrical interpolation mode.

Remedy

- Before commanding G111, cancel the following commands.
- Milling mode
- Nose R compensation
- Constant surface speed
- Mixed control (cross axis control)
- Fixed cycle
- Polar coordinate interpolation
- Cylindrical interpolation

P412 No spec: Axis name switch**Details**

Axis name switch (G111) was issued though it is out of specifications.

Remedy

- Check the specifications.

P420 No spec: Para input by program**Details**

Parameter input by program (G10) was commanded though it is out of specifications.

Remedy

- Check the specifications.

P421 Parameter input error**Details**

- The specified parameter No. or set data is illegal.
- An illegal G command address was input in parameter input mode.
- A parameter input command was issued during fixed cycle modal or nose R compensation.
- G10L50, G10L70, G11 were not commanded in independent blocks.

Remedy

- Correct the program.

P430 R-pnt return incomplete**Details**

- A command was issued to move an axis, which has not returned to the reference position, away from that reference position.
- A command was issued to an axis removal axis.

Remedy

- Execute reference position return manually.
- Disable the axis removal on the axis for which the command was issued.

P431 No spec: 2,3,4th R-point ret**Details**

A command for second, third or fourth reference position return was issued though there are no such command specifications.

Remedy

- Check the specifications.

P432 No spec: Start position return**Details**

Start position return (G29) was commanded though it is out of specifications.

Remedy

- Check the specifications.

P433 No spec: R-position check**Details**

Reference position check (G27) was commanded though it is out of specifications.

Remedy

- Check the specifications.

P434 Compare error**Details**

One of the axes did not return to the reference position when the reference position check command (G27) was executed.

Remedy

- Correct the program.

P435 G27 and M commands in a block**Details**

An M command was issued simultaneously in the G27 command block.

Remedy

- Place the M code command, which cannot be issued in a G27 command block, in separate block from G27 command block.

P436 G29 and M commands in a block**Details**

An M command was issued simultaneously in the G29 command block.

Remedy

- Place the M code command, which cannot be issued in a G29 command block, in separate block from G29 command block.

P438 G52 invalid during G54.1**Details**

A local coordinate system command was issued during execution of the G54.1 command.

Remedy

- Correct the program.

P450 No spec: Chuck barrier**Details**

The chuck barrier on command (G22) was specified although the chuck barrier is out of specifications.

Remedy

- Check the specifications.

P451 No spec: Stroke chk bef travel**Details**

Stroke check before travel (G22/G23) was commanded though it is out of specifications.

Remedy

- Check the specifications.

P452 Limit before travel exists**Details**

An illegal command, which places the axis travel start/end point in the prohibited area or moves the axis through the prohibited area, was detected when Stroke check before travel (G22) was commanded.

Remedy

- Correct the coordinate values of the axis address commanded in the program.

P460 Tape I/O error**Details**

An error has occurred in the tape reader. Otherwise an error has occurred in the printer during macro printing.

Remedy

- Check the power and cable of the connected devices.
- Correct the I/O device parameters.

P461 File I/O error**Details**

- A file of the machining program cannot be read.
- IC card has not been inserted.

Remedy

- In memory mode, the programs stored in memory may have been destroyed. Output all of the programs and tool data and then format the system.
- Ensure that the external device (including an IC card, etc) that contains the file is mounted.
- Correct the parameter settings for HD operation or IC card operation.

P462 Computer link commu error**Details**

A communication error occurred during the BTR operation.

Remedy

- "L01 Computer link error" is displayed simultaneously. Take the remedy corresponding to the error No.

P480 No spec: Milling**Details**

- Milling was commanded though it is out of specifications.
- Polar coordinate interpolation was commanded though it is out of specifications.

Remedy

- Check the specifications.

P481 Illegal G code (mill)

Details

- An illegal G code was used during the milling mode.
- An illegal G code was used during cylindrical interpolation or polar coordinate interpolation.
- The G07.1 command was issued during the tool radius compensation.

Remedy

- Correct the program.

P482 Illegal axis (mill)

Details

- A rotary axis was commanded during the milling mode.
- Milling was executed though an illegal value was set for the milling axis No.
- Cylindrical interpolation or polar coordinate interpolation was commanded during mirror image.
- Cylindrical interpolation or polar coordinate interpolation was commanded before the tool compensation was completed after the T command.
- G07.1 was commanded when cylindrical interpolation was not possible (there is no rotary axis, or external mirror image is ON).
- An axis other than a cylindrical coordinate system axis was commanded during cylindrical interpolation.

Remedy

- Correct the machining program, parameters and PLC interface signals.

P484 R-pnt ret incomplete (mill)

Details

- Movement was commanded to an axis that had not completed reference position return during the milling mode.
- Movement was commanded to an axis that had not completed reference position return during cylindrical interpolation or polar coordinate interpolation.

Remedy

- Carry out manual reference position return.

P485 Illegal modal (mill)

Details

- The milling mode was turned ON during nose R compensation or constant surface speed control.
- A T command was issued during the milling mode.
- The mode was switched from milling to cutting during tool compensation.
- Cylindrical interpolation or polar coordinate interpolation was commanded during the constant surface speed control mode (G96).
- The command unacceptable in the cylindrical interpolation was issued.
- A T command was issued during the cylindrical interpolation or polar coordinate interpolation mode.
- A movement command was issued when the plane was not selected just before or after the G07.1 command.
- A plane selection command was issued during the polar coordinate interpolation mode.
- Cylindrical interpolation or polar coordinate interpolation was commanded during tool radius compensation.
- The G16 plane in which the radius value of a cylinder is "0" was specified.
- A cylindrical interpolation or polar coordinate interpolation command was issued during coordinate rotation by program.

Remedy

- Correct the program.
- Issue G40 or G97 before issuing G12.1.
- Issue a T command before issuing G12.1.
- Issue G40 before issuing G13.1.
- Specify the radius value of a cylinder other than "0", or specify the X axis's current value other than "0" before issuing G12.1/G16.

P486 Milling error**Details**

- The milling command was issued during the mirror image (when parameter or external input is turned ON).
- Polar coordinate interpolation, cylindrical interpolation or milling interpolation was commanded during mirror image for facing tool posts.
- The start command of the cylindrical interpolation or polar coordinate interpolation was issued during the normal line control.

Remedy

- Correct the program.

P501 Cross (G110) impossible**Details**

Mixed control (cross axis control) command (G110) was issued in the following modes.

- During nose R compensation mode
- During pole coordinate interpolation mode
- During cylindrical interpolation mode
- During balance cut mode
- During fixed cycle machining mode
- During facing turret mirror image
- During constant surface speed control mode
- During hobbing mode
- During axis name switch

Remedy

- Correct the program.

P503 Illegal G110 axis**Details**

- The commanded axis does not exist.
- The mixed control (cross axis control) (G110) was commanded to the axis for which the mixed control (cross axis control) is disabled.
- The number of axes included in the mixed control (cross axis control) (G110) command is exceeding the maximum number of axes per part system.

Remedy

- Correct the program.

P505 Hobbing axis selection illegal**Details**

The axis selected with the hobbing workpiece axis selection signal is not the rotary axis. Or, the number of the NC axes in the part system is exceeded.

Remedy

Check if the axis for which the hobbing workpiece axis selection is set is the rotary axis and it's a NC axis in the part system.

P506 Sp-sp polygon axis illegal**Details**

When G52.1 is commanded and "#1292 ext28/bit6" is enabled(1), the spindle selected with the signal of the spindle-spindle polygon machining workpiece axis selection falls under either of following conditions.

- Unconnected spindle number is selected.
- The spindle is not serially connected.

Remedy

Correct the value of the spindle-spindle polygon machining workpiece axis selection.

P511 Synchronization M code error

Details

- Two or more synchronization M codes were commanded in the same block.
- The synchronization M code and "!" code were commanded in the same block.
- Synchronization with the M code was commanded in 3rd part system or more. (Synchronization with the M code is valid only in 1st part system or 2nd part system.)

Remedy

- Correct the program.

P520 Control axis superimposition/Designated axis illegal

Details

An axis which was impossible to superimpose was designated as a master axis or superimposing axis.

Remedy

Correct the program.

P530 DEC. POINT ERR

Details

A decimal point was added to the address where the decimal point command is not allowed. ("#1274 ext10/bit0 (Type of address enabling/disabling decimal point command)")

Remedy

Do not add any decimal point to the addresses where the decimal point is not allowed.

P540 No spec: G54.2

Details

G54.2 or G10 L21 was commanded when workpiece position offset for rotary axis was OFF.

Remedy

Check the workpiece position offset for rotary axis.

P544 No spec: Wk instl err cmp

Details

The workpiece installation error compensation function is out of the specifications.

Remedy

- Check the specifications.

P545 Invlid cmd in wk instl err cmp

Details

During workpiece installation error compensation, a command impossible to issue (such as G command) was issued.

Remedy

- Check the program. If you wish to issue a command impossible to issue (such as G command) during workpiece installation error compensation, cancel workpiece installation error compensation once.

P546 Wk instl err cmp cmd invalid

Details

- Workpiece installation error compensation was commanded in a G modal in which commanding it is not allowed.
- An illegal G command was issued in the block that has a workpiece installation error compensation command.

Remedy

- Check the program. Also check the G modals which were issued at commanding the workpiece installation error compensation, and cancel illegal ones.
- Issue the G command in a separate block.

P547 Illegal wk instl err cmp cmd**Details**

A command in which the rotary axis's travel distance exceeds 180 degrees was issued.

Remedy

- Divide the travel command so that the rotary axis's travel distance per block is less than 180 degrees.

P550 No spec: G06.2(NURBS)**Details**

There is no NURBS interpolation option.

Remedy

- Check the specifications.

P551 G06.2 knot error**Details**

The knot (k) command value is smaller than the value for the previous block.

Remedy

- Correct the program.
- Specify the knot by monotone increment.

P552 Start point of 1st G06.2 err**Details**

The block end point immediately before the G06.2 command and the G06.2 first block command value do not match.

Remedy

- Match the G06.2 first block coordinate command value with the previous block end point.

P554 Invl manual interrupt in G6.2**Details**

Manual interruption was executed in a block that applies the G06.2 mode.

Remedy

- Execute the manual interruption in the block that does not apply the G06.2 mode.

P555 Invalid restart during G06.2**Details**

Restart was attempted from the block that applies G06.2 mode.

Remedy

- Restart from the block that does not apply the G06.2 mode.

P600 No spec: Auto TLM**Details**

An automatic tool length measurement command (G37) was issued though it is out of specifications.

Remedy

- Check the specifications.

P601 No spec: Skip**Details**

A skip command (G31) was issued though it is out of specifications.

Remedy

- Check the specifications.

P602 No spec: Multi skip**Details**

A multiple skip command (G31.1, G31.2, G31.3 or G31 Pn) was issued though it is out of specifications.

Remedy

- Check the specifications.

P603 Skip speed 0**Details**

The skip speed is "0".

Remedy

- Specify the skip speed.

P604 TLM illegal axis**Details**

No axis was specified in the automatic tool length measurement block. Otherwise, two or more axes were specified.

Remedy

- Specify only one axis.

P605 T & TLM command in a block**Details**

The T code is in the same block as the automatic tool length measurement block.

Remedy

- Specify the T code before the automatic tool length measurement block.

P606 T cmdnd not found before TLM**Details**

The T code was not yet specified in automatic tool length measurement.

Remedy

- Specify the T code before the automatic tool length measurement block.

P607 TLM illegal signal**Details**

The measurement position arrival signal turned ON before the area specified by the D command or "#8006 ZONE d". Otherwise, the signal remained OFF to the end.

Remedy

- Correct the program.

P608 Skip during radius compen**Details**

A skip command was issued during radius compensation processing.

Remedy

- Issue a radius compensation cancel (G40) command or remove the skip command.

P610 Illegal parameter**Details**

- The parameter setting is not correct.
- G114.1 was commanded while the spindle synchronization was selected with the PLC interface signal.
- G110 was commanded while the mixed control (cross axis control) was selected with the PLC interface signal.
- G125 was commanded while the control axis synchronization across part systems was selected with the PLC interface signal.

Remedy

- Correct the settings of "#1514 expLinax (Exponential function interpolation linear axis)" and "#1515 expRotax (Exponential function interpolation rotary axis)".
- Correct the program.
- Correct the parameter settings.

Details

- The chopping command (G81.1) was issued while the chopping command method from the PLC signal was selected.
- The axis for which "#8223 G10.6 retract amount" was set to other than "0" was the index table indexing axis.

Remedy

- Change the chopping command method into G command method.
- Set "0" to "2076 index_x" of the axis for which "#8223 G10.6 retract amount" is set to other than "0".
- If "8223 G10.6 retract amount" is set on the axis as the index table indexing axis, set "0" to "2076 index_x" and "8223 G10.6 retract amount", and then put "1" to "2076 index_x" once more.

P611 No spec: Exponential function**Details**

There is no specification for the exponential interpolation.

Remedy

- Check the specifications.

P612 Exponential function error**Details**

A travel command for exponential interpolation was issued during mirror image for facing tool posts.

Remedy

- Correct the program.

P700 Illegal command value**Details**

Spindle synchronization was commanded to a spindle that is not connected serially.

Remedy

- Correct the program.
- Correct the parameter settings.

P900 No spec: Normal line control**Details**

A normal line control command (G40.1, G41.1, or G42.1) was issued though it is out of specifications.

Remedy

- Check the specifications.

P901 Normal line control axis G92**Details**

A coordinate system preset command (G92) was issued to a normal line control axis during normal line control.

Remedy

- Correct the program.

P902 Normal line control axis error**Details**

- The normal line control axis was set to a linear axis.
- The normal line control axis was set to the linear type rotary axis II axis.
- The normal line control axis has not been set.
- The normal line control axis is the same as the plane selection axis.

Remedy

- Correct the normal line control axis setting.

P903 Plane chg in Normal line ctrl**Details**

The plane selection command (G17, G18, or G19) was issued during normal line control.

Remedy

- Delete the plane selection command (G17, G18, or G19) from the program of the normal line control.

P920 No spec: 3D coord conv**Details**

There is no specification for 3-dimensional coordinate conversion.

Remedy

- Check the specifications.

P921 Illegal G code at 3D coord**Details**

The commanded G code cannot be performed during 3-dimensional coordinate conversion modal.

Remedy

- Correct the program.
- If "#1229 set01/bit3 (Initial constant surface speed)" is enabled, disable the parameter or issue the constant surface speed control cancel (G97) command.
- If a synchronous tap command, which leads the inclined axis' movement, has been issued during 3-dimensional coordinate conversion, change the command to the one which does not lead the inclined axis' movement.

P922 Illegal mode at 3D coord**Details**

The modal does not allow the 3-dimensional coordinate conversion command.

Remedy

Correct the program.

P923 Illegal addr in 3D coord blk**Details**

The G code, issued with G68.1 in the same block, is not allowed to be used with G68.1.

Remedy

- Correct the program.

P930 No spec: Tool axis compen**Details**

A tool length compensation along the tool axis command was issued though it is out of specifications.

Remedy

- Check the specifications.

P931 Executing tool axis compen**Details**

There is a G code that cannot be commanded during tool length compensation along the tool axis.

Remedy

- Correct the program.

P932 Rot axis parameter error**Details**

There is an illegal linear axis name or rotary axis name set in the rotary axis configuration parameters. There is an illegal setting in the parameter concerning the configuration of the inclined surface machining axis.

Remedy

- Set the correct value and turn the power ON again.

P940 No spec: Tool tip control**Details**

There is no specification for tool tip center control.

Remedy

- Check the specifications.

P941 Invalid T tip control command**Details**

A tool tip center control command was issued during a modal for which a tool tip center control command cannot be issued.

Remedy

- Correct the program.

Details

- This axis configuration cannot be commanded the tool center point control type 2.
- The tool center point control is commanded with an axis configuration outside the specification.

Remedy

- Correct the parameter of the rotary axis configuration or the program.
- Set three orthogonal coordinates axes and a rotary axis for the axis configuration of the rotary axis configuration parameter.

P942 Invalid cmd during T tip ctrl**Details**

A G code that cannot be commanded was issued during tool tip center control.

Remedy

- Correct the program.

P943 Tool posture command illegal**Details**

In tool tip center control type 1, if the signs at the tool-side rotary axis or table base-side rotary axis start and finish points differ, a tool base-side rotary axis or table workpiece-side rotary axis rotation exists for the same block, and does not pass a singular point.

In tool tip center control type 2, the posture vector command is incorrect.

Remedy

- Correct the program.

P950 No spec: Tilt face machining**Details**

Inclined surface machining option is not supported.

Remedy

- Check the specifications.

P951 Ill cmd in tilt face machining**Details**

A forbidden command (G command, etc) was issued during inclined surface machining.

Remedy

- Check the program. If you want to execute a command (G command, etc) that is unavailable during inclined surface machining, cancel the inclined surface machining.

P952 Inclined face cut prohibited

Details

Inclined surface machining was commanded during the mode where the machining is unavailable.
Inclined surface machining was commanded during interruption.

Remedy

- Check the program and see whether any unavailable mode is included during inclined surface machining command. If any, cancel that mode.

P953 Tool axis dir cntrl prohibited

Details

Tool axis direction control was commanded during the mode where the control is unavailable.

Remedy

- Check the program and see whether any unavailable mode is included during tool axis direction control. If any, cancel that mode.

P954 Inclined face command error

Details

The address to issue the inclined surface machining command is incorrect.

Remedy

- Check the program.

P955 Inclined face coord illegal

Details

Impossible to define an inclined surface with the values you specified.

Remedy

- Check the program.

P958 Tool axis dir ctrl axis illeg

Details

The command is executed in an angle, which does not allow the tool axis direction control with four axes.

Remedy

- Check the feature coordinate system defined by the inclined surface machining demand.

P970 No spec : Involute interpolation

Details

There is no specification of the involute interpolation.

Remedy

- Check the specification.

P971 Invalid cmd in involute interp

Details

The issued G code command is illegal during involute interpolation modal.

Remedy

- Correct the program.

P972 Involute interp. cmd invalid

Details

A involute interpolation is commanded in a modal in which the involute interpolation is not acceptable.

Remedy

- Correct the program.

P990 PREPRO error**Details**

Combining commands that required pre-reading (nose R offset, corner chamfering/corner rounding, geometric I, geometric IB, and compound type fixed cycle for turning machining) resulted in eight or more pre-read blocks.

Remedy

- Delete some or all of the combinations of commands that require pre-reading.

Explanation of Parameters

2.1 Machining Parameters

The parameters with "(PR)" requires the CNC to be turned OFF after the settings. Turn the power OFF and ON to enable the parameter settings.

【#8000】 CNT TYPE

Select the M code that counts up the number of workpiece machining.
 0: M code designated by "#8001 WRK COUNT M"
 1: M code designated by "#8001 WRK COUNT M", and M02/M30
 2: M02/M30

【#8001】 WRK COUNT M

Set the M code for counting the number of the workpiece repeated machining.
 The number of the M-codes set by this parameter is counted.
 The No. will not be counted when set to "0".

---Setting range---
 0 to 999

【#8002】 WRK COUNT

Set the initial value of the number of workpiece machining. The number of current workpiece machining is displayed.

---Setting range---
 0 to 999999

【#8003】 WRK LIMIT

Set the maximum number of workpiece machining.
 A signal will be output to PLC when the number of machining times is counted to this limit.

---Setting range---
 0 to 999999

【#8004】 SPEED

Set the feedrate during automatic tool length measurement.

---Setting range---
 1 to 100000 (mm/min)

【#8005】 ZONE r

Set the distance between the measurement point and deceleration start point.

---Setting range---
 0 to 99999.999 (mm)

【#8006】 ZONE d

Set the tolerable range of the measurement point.
 An alarm will occur when the sensor signal turns ON before the range, set by this parameter, has not been reached from the measurement point, or when the signal does not turn ON after the range is passed.

---Setting range---
 0 to 99999.999 (mm)

【#8007】 OVERRIDE

Set the override value for automatic corner override.

---Setting range---
 0 to 100 (%)

【#8008】 MAX ANGLE

Set the maximum corner opening angle where deceleration should start automatically. When the angle is larger than this value, deceleration will not start.

---Setting range---
0 to 180 (°)

【#8009】 DSC. ZONE

Set the position where deceleration starts at the corner. Designate at which length point before the corner deceleration should start.

---Setting range---
0 to 99999.999 (mm)

【#8010】 ABS. MAX. (for L system only)

Set the maximum value when inputting the tool wear compensation amount. A value exceeding this setting value cannot be set.

---Setting range---
0 to 999.999 (mm)
(Input setting increment applies)

【#8011】 INC. MAX. (for L system only)

Set the maximum value for when inputting the tool wear compensation amount in the incremental mode.

---Setting range---
0 to 999.999 (mm)
(Input setting increment applies)

【#8012】 G73 n

Set the return amount for G73 (step cycle).
Set the return amount for MITSUBISHI CNC special format G83.1.

---Setting range---
0 to 99999.999 (mm)

【#8013】 G83 n

Set the return amount for G83 (deep hole drilling cycle).

---Setting range---
0 to 99999.999 (mm)

【#8014】 CDZ-VALE (for L system only)

Set the screw cut up amount for G76 and G78 (thread cutting cycle).

---Setting range---
0 to 127 (0.1 lead)

【#8015】 CDZ-ANGLE (for L system only)

Set the screw cut up angle for G76 and G78 (thread cutting cycle).

---Setting range---
0 to 89 (°)

【#8016】 G71 MINIMUM (for L system only)

Set the minimum value of the last cutting amount by the rough cutting cycle (G71, G72). The cutting amount of the last cutting will be the remainder. When the remainder is smaller than this parameter setting, the last cycle will not be executed.

---Setting range---
0 to 999.999 (mm)

【#8017】 G71 DELTA-D (for L system only)

Set the change amount of the rough cutting cycle.
 The rough cutting cycle (G71, G72) cutting amount repeats $d + \Delta d$, d , $d - \Delta d$ using the value (d) commanded with D as a reference. Set the change amount Δd .

---Setting range---
 0 to 999.999 (mm)

【#8018】 G84/G74 n

Set the retract amount m in a G84/G74/G88 pecking tapping cycle.
 (Note) In the case of a normal tapping cycle, set to "0".

【#8019】 R COMP

Set a compensation coefficient for reducing a control error in the reduction of a corner roundness and arc radius.
 The larger the set value is, the smaller the theoretical error will be. However, since the speed at the corner goes down, the cycle time will be extended.
 Coefficient = 100 - set value
 (Note) This function will be enabled when "#8021 COMP_CHANGE" is set to "0".

---Setting range---
 0 to 99 (%)

【#8020】 DCC. angle

Set the minimum value of an angle (external angle) that should be assumed to be a corner.
 When an inter-block angle (external angle) in high-accuracy mode is larger than the set value, it will be determined as a corner and the speed will go down to sharpen the edge.

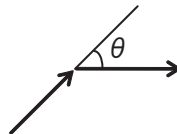

If the set value is smaller than θ , the speed goes down to optimize the corner.

(Note) If "0" is set, it will be handled as "5" degrees.

---Setting range---
 0 to 89 (°)
 0: 5 degree (Equals to setting "5")

【#8021】 COMP_CHANGE

Select whether to share or separate the compensation coefficient at the corner/curve during the high-accuracy control mode.
 0: Share ("#8019 R COMP" is applied.)
 1: Separate
 - Corner : #8022 CORNER COMP
 - Curve : #8023 CURVE COMP
 (Note) Set "1" when using SSS control.

【#8022】 CORNER COMP

Set the compensation coefficient to further reduce or increase the roundness at the corner during the high-accuracy control mode.
 Coefficient = 100 - setting value
 (Note) This is valid when "#8021 COMP CHANGE" is set to "1".

---Setting range---
 -1000 to 99 (%)

【#8023】 CURVE COMP

Set the compensation coefficient to further reduce or increase the radius reduction amount at the curve (arc, involute, spline) during the high-accuracy control mode.

Coefficient = 100 - setting value

(Note) This is valid when "#8021 COMP CHANGE" is set to "1".

---Setting range---

-1000 to 99 (%)

【#8025】 SPLINE ON (for M system only)

Select whether to enable the spline function.

0: Disable

1: Enable

【#8026】 CANCEL ANG. (for M system only)

Set the angle where the spline interpolation is temporarily canceled.

When the angle made by blocks exceeds this parameter setting value, spline interpolation will be canceled temporarily. In consideration of the pick feed, set a value a little smaller than the pick feed angle.

---Setting range---

0 to 180 (°)

0: 180 (°)

【#8027】 Toler-1 (for M system only)

Set the maximum chord error (tolerance) in a block that includes an inflection point. Set the tolerance applicable when the applicable block is developed to fine segments by CAM. (normally about 10 μ m)

When "0.000" is set, the applicable block will be linear.

---Setting range---

0.000 to 100.000 (mm)

【#8028】 Toler-2 (for M system only)

Set the maximum chord error (tolerance) in a block that includes no inflection point. Set the tolerance applicable when the applicable block is developed to fine segments by CAM. (normally about 10 μ m)

When "0.000" is set, the applicable block will be linear.

---Setting range---

0.000 to 100.000 (mm)

【#8029】 FairingL (for M system only)

Set the length of the block subject to fairing.

(Enabled when "#8033 Fairing ON" is set to "1".)

---Setting range---

0 to 100.000 (mm)

【#8030】 MINUTE LENG (for M system only)

Set the fine-segment length where the spline interpolation is temporarily canceled.

When the length of one block exceeds this parameter setting value, spline interpolation is canceled temporarily and linear interpolation is performed. Set a value a little smaller than one block length of the program.

If "-1" is set, spline interpolation will be performed regardless of block length.

---Setting range---

-1 to 127 (mm)

0: 1 (mm)

【#8033】 Fairing ON (for M system only)

Set whether to use the fairing function.
 0: Not use
 1: Use

【#8034】 AccClamp ON (for M system only)

Select the method for clamping the cutting speed.
 0: Clamp with parameter "#2002 clamp" or the corner deceleration function.
 1: Clamp the cutting speed with acceleration judgment.
 (Enabled when "#8033 Fairing ON" is set to "1".)

【#8035】

Not used. Set to "0".

【#8036】 CordecJudge (for M system only)

Select the condition to decide a corner.
 0: A corner is decided from the angle of the neighboring block.
 1: A corner is decided from the angle of the neighboring block, excluding minute blocks.
 (Enabled when "#8033 Fairing ON" is set to "1".)

【#8037】 CorJudgeL (for M system only)

Set the length of the block to be excluded when deciding a corner.
 (Enabled when "#8036 CordecJudge" is set to "1".)

---Setting range---
 0 to 99999.999 (mm)

【#8041】 C-rot.R

Set the length from the center of the normal line control axis to the tool tip. This is used to calculate the turning speed at the block joint.
 This is enabled during the normal line control type II.

---Setting range---
 0.000 to 99999.999 (mm)

【#8042】 C-ins.R

Set the radius of the arc to be automatically inserted into the corner during normal line control.
 This is enabled during the normal line control type I.

---Setting range---
 0.000 to 99999.999 (mm)

【#8043】 Tool HDL FD OFS

Set the length from the tool holder to the tool tip.

---Setting range---
 0.000 to 99999.999 (mm)

【#8044】 UNIT*10

Set the command increment scale.
 The scale will be "1" when "0" is set.

---Setting range---
 0 to 10000 (fold)
 0: One fold

【#8045】 VariableFeedThread

Select whether to enable variable feed thread cutting function.
 0: Disable
 1: Enable

【#8051】 G71 THICK

Set the amount of cut-in by the rough cutting cycle (G71, G72)

---Setting range---
0 to 99999.999 (mm)

【#8052】 G71 PULL UP

Set the amount of pull-up when returning to the cutting start point for the rough cutting cycle (G71, G72).

---Setting range---
0 to 99999.999 (mm)

【#8053】 G73 U

Set the X-axis cutting margin of the forming rough cutting cycle (G73).

---Setting range---
-99999.999 to 99999.999 (mm)

【#8054】 G73 W

Set the Z-axis cutting margin of the forming rough cutting cycle (G73).

---Setting range---
-99999.999 to 99999.999 (mm)

【#8055】 G73 R

Set how many times cutting will be performed in the forming rough cutting cycle (G73).

---Setting range---
0 to 99999 (times)

【#8056】 G74 RETRACT

Set the amount of retract (amount of cut-up) of the cutting-off cycle (G74, G75).

---Setting range---
0 to 999.999 (mm)

【#8057】 G76 LAST-D

Set the amount of final cut-in by the compound type thread cutting (G76).

---Setting range---
0 to 999.999 (mm)

【#8058】 G76 TIMES

Set how many times the amount of final cut-in cycle (G76 finish margin) will be divided in the compound type thread cutting (G76).

---Setting range---
0 to 99 (times)

【#8059】 G76 ANGLE

Set the angle (thread angle) of the tool nose in the compound type thread cutting (G76).

---Setting range---
0 to 99 (°)

【#8060】 G71 ERR

Set the error amount of finished shape in rough cutting cycle (with G71 or G72).
When the finished shape's Z axis (or X axis at G72 command) does not move monotonously, a program error (or a shape change at pocket machining) will occur. Set a value to avoid such an error for the minute inversion.

---Setting range---
0 to 0.010 (mm)

【#8061】 G76 THICK

Set the minimum cutting amount for compound type thread cutting cycle (G76).
The value set in this parameter will be applied when the cutting amount in compound thread cutting cycle (G76) without Q command is smaller than that in this parameter.
This parameter is valid only when "#1222 aux06/bit4" is set to "1".

---Setting range---
0.000 to 99999.999 (mm)

【#8062】 ThreadPullUp

Select the speed relieving up to the height of the cycle start point by the relieving operation after the thread cutting in the thread cutting cycle.
When this parameter is set to "1", the rapid traverse override for the relieving operation after the thread cutting will be disabled.
0 : Rapid traverse rate
1 : Rapid traverse rate in #8063

【#8063】 PullUpSpeed

Set the rapid traverse rate for the relieving operation after the thread cutting in the thread cutting cycle.
(Note 1) If this parameter setting value exceeds the rapid traverse rate in #2001, the clamp will be applied at the rate in #2001.
(Note 2) The time constant and acceleration/deceleration type are same as rapid traverse.
0 : Setting feedrate in "#2001 rapid"
1 to 1000000mm/min : Setting feedrate

【#8071】 3-D CMP (for M system only)

Set the value of the denominator constants for 3-dimensional tool radius compensation.
Set the value of "p" in the following formula.
 $V_x = i \times r/p$, $V_y = j \times r/p$, $V_z = k \times r/p$
 V_x , V_y , V_z : X, Y, and Z axes or vectors of horizontal axes
i, j, k : Program command value
r : Offset
 $p = \sqrt{(i^2 + j^2 + k^2)}$ when the set value is "0".

---Setting range---
0 to 99999.999

【#8072】 SCALING P (for M system only)

Set the scale factor for reduction or magnification in the machining program specified by G50 or G51 command.
This parameter will be valid when the program specifies no scale factor.

---Setting range---
-99.999999 to 99.999999

【#8075】 SpiralEndErr (for M system only)

Set the tolerable error range (absolute value) when the end point position, commanded by the spiral or conical interpolation command with the command format type 2, differs from the end point position obtained from the speed and increment/decrement amount.

---Setting range---
0 to 99999.999 (mm)

【#8077】 Involute error

For the involute interpolation, set a tolerance of the margin of error between the involute curves passing on the start point and the end point.

---Setting range---
0.000 to 99999.999 (mm)

【#8078】 Screen Saver Timer

Not used. Set to "0".

【#8081】 Gcode Rotat

Set the rotation angle for the program coordinate rotation command.
This parameter is enabled when "1" is set in "#1270 ext06/bit5 (Coordinate rotation angle without command)".
This parameter is set as absolute value command regardless of the "#8082 G68.1 R INC" setting. If the rotation angle is designated by an address R in G68.1 command, the designation by program will be applied.

---Setting range---
-360.000 to +360.000 (°)

【#8082】 G68.1 R INC (for L system only)

Select absolute or increment command to use for the rotation angle command R at L-system coordinate rotation.

0: Use absolute value command in G90 modal, incremental value command in G91 modal
1: Always use incremental value command

(Note) If G91 does not exist in the G code system, the command type is decided by this parameter only.

【#8083】 G83S modeM (for M system only)

Set the M command code for changing to the small diameter deep hole drilling cycle mode.

---Setting range---
1 to 99999999

【#8084】 G83S Clearance (for M system only)

Set the clearance amount for the small diameter deep hole drilling cycle (G83).

---Setting range---
0 to 999.999 (mm)

【#8085】 G83S Forward F (for M system only)

Set the feedrate from the R point to the cutting start position in the small diameter deep hole drilling cycle (G83).

---Setting range---
0 to 99999 (mm/min)

【#8086】 G83S Back F (for M system only)

Set the speed for returning from the hole bottom during the small diameter deep hole drilling cycle (G83).

---Setting range---
0 to 99999 (mm/min)

【#8090】 SSS ON

Set whether to enable the SSS control with G05 P10000.

0: Disable
1: Enable

【#8091】 StdLength

Set the maximum value of the range for recognizing the shape.
To eliminate the effect of steps or errors, etc., set a large value. To enable sufficient deceleration, set a small value.
If "0.000" is set, the standard value (1.000mm) will be applied.

---Setting range---
0 to 100.000 (mm)

【#8092】 ClampCoeff

Set the clamp speed at the curved section configured of fine segments.
Coefficient = $\sqrt{\text{setting value}}$

---Setting range---
1 to 100

【#8093】 StepLeng

Set the width of the step at which the speed is not to be decelerated. (Approximately the same as the CAM path difference [Tolerance].)
If "0" is set, the standard value (5 μ m) will be applied.
If a minus value is set, the speed will decelerate at all minute steps.

---Setting range---
-1.000 to 0.100 (mm)

【#8094】 DccWaitAdd

Set the time to wait for deceleration when the speed FB does not drop to the clamp speed.

---Setting range---
0 to 100 (ms)

【#8101】 MACRO SINGLE

Select how to control the blocks where the user macro command continues.
0: Do not stop while macro blocks continue.
1: Stop every block during signal block operation.

【#8102】 COLL. ALM OFF

Select the interference (bite) control to the workpiece from the tool diameter during tool radius compensation and nose R compensation.
0: An alarm will be output and operation stops when an interference is judged.
1: Changes the path to avoid interference.

【#8103】 COLL. CHK OFF

Select the interference (bite) control to the workpiece from the tool diameter during tool radius compensation and nose R compensation.
0: Performs interference check.
1: Does not perform interference check.

【#8105】 EDIT LOCK B

Select the edit lock for program Nos. 8000 to 9999 in the memory.
0: Enable the editing.
1: Prohibit the editing of above programs.

When "1" is set, the file cannot be opened.

【#8106】 G46 NO REV-ERR (for L system only)

Select the control for the compensation direction reversal in G46 (nose R compensation).
0: An alarm will be output and operation will stop when the compensation direction is reversed (G41 -> G42' G42 -> G41).
1: An alarm won't occur when the compensation direction is reversed, and the current compensation direction will be maintained.

【#8107】 R COMPENSATION

Select whether to move to the inside because of a delay in servo response to a command during arc cutting mode.

- 0: Move to the inside, making the arc smaller than the command value.
- 1: Compensate the movement to the inside.

【#8108】 R COMP Select

Select the arc radius error compensation target.

- 0: Perform compensation over all axes.
- 1: Perform compensation axis by axis.

(Note) This parameter is effective only when "#8107 R COMPENSATION" is "1".

【#8109】 HOST LINK

Select whether to enable computer link B instead of the RS-232C port.

- 0: Disable (Enable normal RS-232C communication.)
- 1: Enable (Disable normal RS-232C communication.)

【#8110】 G71/G72 POCKET

Select whether to enable the pocket machining when there is a dimple (pocket) in the rough cutting cycle (G71, G72) finishing program.

- 0: OFF
- 1: ON

【#8111】 Milling Radius

Select the diameter and radius of the linear axis for milling (cylindrical/pole coordinate) interpolation.

- 0: All axes radius command
- 1: Each axis setting (follows "#1019 dia")

(Note) This parameter is valid only in the milling (cylindrical/polar coordinate) interpolation mode.

【#8112】 DECIMAL PNT-P

Select whether to enable the decimal point command for G04 address P.

- 0: Disable
- 1: Enable

【#8113】 Milling Init G16

Set which plane to execute for milling machining after the power is turned ON or reset.

#8113:0, #8114:0 ---> G17 plane
 #8113:0, #8114:1 ---> G19 plane
 #8113:1, #8114:0 ---> G16 plane
 #8113:1, #8114:1 ---> G16 plane

- 0: Not G16 plane
- 1: G16 plane

(Note) This parameter is valid for the G code system 2 or 3 ("#1037 cmdtyp"="3" or "4").

【#8114】 Milling Init G19

Set which plane to execute for milling machining after the power is turned ON or reset.

#8113:0, #8114:0 ---> G17 plane
 #8113:0, #8114:1 ---> G19 plane
 #8113:1, #8114:0 ---> G16 plane
 #8113:1, #8114:1 ---> G16 plane

- 0: Not G19 plane
- 1: G19 plane

(Note) This parameter is valid for the G code system 2 or 3 ("#1037 cmdtyp"="3" or "4").

【#8115】 G83/87 RAPID

Select the operation upon the completion of each step in deep hole drilling cycle (G83, G87).
 0: Returns by the amount of d (parameter setting) setting value before performing next step.
 1: Returns to R point before performing next step

【#8116】 Coord rot para invd

Not used. Set to "0".

【#8117】 OFS Diam DESIGN

Select tool radius or tool diameter compensation amount to be specified.
 0: Tool radius compensation amount
 1: Tool diameter compensation amount

【#8122】 Keep G43 MDL M-REF

Select whether to keep the tool length offset by high speed manual reference position return during tool length offset.
 0: Will not be kept (Cancel)
 1: Kept

【#8123】 H-spd retract ON

Select whether to enable the drilling cycle at high-speed retract in fixed cycle for drilling.
 0: Disable
 1: Enable

【#8124】 Mirr img at reset

Select the operation type of the mirror image by parameter setting and the mirror image by external input.
 0: The current mirror image is canceled, and new mirror image will start with the machine position at reset as the mirror center.
 1: The mirror center is kept to continue the mirror image.

【#8125】 Check Scode in G84

Select how to operate when there is no S command in synchronous tapping block.
 0: Use the spindle function modal value as S-command value.
 1: Output a program error.

【#8128(PR)】 Host PC for op

Specify the device that stores programs for HD operation and subprogram operation.
 0: PC of IP address set to parameter #11005.
 * 0.0.0.0 for parameter "#11005" is the display unit.
 1: Display unit

【#8145】 Validate F1 digit

Select whether to execute the F command with a 1-digit code command or with a direct numerical command.
 (The same value as "#1079 F1digit" will be reflected. When either setting changes, the other will change accordingly.)
 0: Direct numerical command (command feedrate during feed per minute or rotation)
 1: 1-digit code command (with the feedrate specified by the parameters "#1185 spd_F1" to "#1189 spd_F5")

【#8155】 Sub-pro interrupt

Select the method for the user macro interrupt.
 (The same value as "#1229 set01/bit0" will be reflected. When either setting changes, the other will change accordingly.)
 0: The user macro interrupt of macro type
 1: The user macro interrupt of sub-program type

【#8156】 Fine thread cut E

Select the address E type when cutting an inch screw.
(The same value as "#1229 set01/bit1" will be reflected. When either setting changes, the other will change accordingly.)

- 0: Specify the number of threads per inch for inch screw cutting.
- 1: Specify the precision lead for inch screw cutting.

【#8157】 Radius comp type B (M system) / Nose R comp type B (L system)

For M system

Select the method of the arithmetic processing for the intersection point when the start-up or cancel commands are operated during radius compensation.

(The same value as "#1229 set01/bit2" will be reflected. When either setting changes, the other will change accordingly.)

- 0: The processing does not handle the start-up or cancel command block: handle the offset vector in the direction vertical to that of the command instead.
- 1: The processing is executed for the intersection point between the command block and the next block.

For L system

Select the method of the arithmetic processing for the intersection point when the start-up or cancel commands are operated during nose R or radius compensation.

(The same value as "#1229 set01/bit2" will be reflected. When either setting changes, the other will change accordingly.)

- 0: The processing does not handle the start-up or cancel command block: handle the offset vector in the direction vertical to that of the command instead.
- 1: The processing is executed for the intersection point between the command block and the next block.

【#8158】 Init const sur spd

Select the initial state after power-ON.

(The same value as "#1229 set01/bit3" will be reflected. When either setting changes, the other will change accordingly.)

- 0: Constant surface speed control cancel mode.
- 1: Constant surface speed control mode.

【#8159】 Synchronous tap

Select whether to use the floating tap chuck in G74 and G84 tap cycles.

(The same value as "#1229 set01/bit4" will be reflected. When either setting changes, the other will change accordingly.)

- 0: With a floating tapping chuck
- 1: Without a floating tapping chuck

【#8160】 Start point alarm

Select an operation when the operation start point cannot be found while moving to the next block of G117.

(The same value as "#1229 set01/bit5" will be reflected. When either setting changes, the other will change accordingly.)

- 0: The auxiliary function is enabled after the block for the movement has finished.
- 1: The program error (P33) occurs.

【#8173】 Hold intr amount

Select whether to clear or hold the interruption amount after the "NC reset 1 (or 2)" signal is ON when the manual ABS switch is OFF.

- 0: Clear (Reset the coordinate deviation due to the interruption)
- 1: Hold

【#8201】 AX. RELEASE

Select the function to remove the control axis from the control target.

- 0: Control as normal.
- 1: Remove from control target.

【#8202】 OT-CHECK OFF

Select whether to enable the stored stroke limit II function set in #8204 and #8205.
 0: Enable
 1: Disable

【#8203】 OT-CHECK-CANCEL

Select whether to disable the stored stroke limits I, II (or IIB) and IB from the power ON to the first reference position return.
 0: Enable (according to #8202)
 1: Temporarily cancel

(Note) "#8203 OT-CHECK-CANCEL" affects all the stored stroke limits.

【#8204】 OT-CHECK-N

Set the coordinates of the (-) direction in the movable range of the stored stroke limit II or the lower limit coordinates of the prohibited range of stored stroke limit IIB.
 If the sign and value are the same as #8205, the stored stroke limit II (or IIB) will be invalid.
 If the stored stroke limit IIB function is selected, the prohibited range will be between two points even when #8204 and #8205 are set in reverse. When II is selected, the entire range will be prohibited if #8204 and #8205 are set in reverse.

---Setting range---
 -99999.999 to 99999.999 (mm)

【#8205】 OT-CHECK-P

Set the coordinates of the (+) direction in the movable range of the stored stroke limit II or the upper limit coordinates of the prohibited range of stored stroke limit IIB.

---Setting range---
 -99999.999 to 99999.999 (mm)

【#8206】 TOOL CHG. P

Set the coordinates of the tool change position for G30. n (tool change position return).
 Set with coordinates in the basic machine coordinate system.

---Setting range---
 -99999.999 to 99999.999 (mm)

【#8207】 G76/87 IGNR (for M system only)

Select whether to enable the shift operation at G76 (fine boring) and G87 (back boring).
 0: Enable
 1: Disable

【#8208】 G76/87 (-) (for M system only)

Select the shift direction at G76 and G87.
 0: Shift to (+) direction
 1: Shift to (-) direction

【#8209】 G60 SHIFT (for M system only)

Set the last positioning direction and distance for a G60 (unidirectional positioning) command.

---Setting range---
 -99999.999 to 99999.999 (mm)

【#8210】 OT INSIDE

Select whether the stored stroke limit function set by #8204 and #8205 prevents the machine from moving to the inside or outside of the specified range.
 0: Inhibits outside area (Select stored stroke limit II.)
 1: Inhibits inside area (Select stored stroke limit II B.)

【#8211】 MIRR. IMAGE

Select whether to enable the parameter mirror image function.

- 0: Disable
- 1: Enable

【#8213(PR)】 Rotation axis type

Select the rotation type (short-cut valid/invalid) or linear type (workpiece coordinate linear type/all coordinate linear type).

This parameter is enabled only when "#1017 rot" is set to "1". (Note)

- 0: Short-cut invalid
- 1: Short-cut valid
- 2: Workpiece coordinate linear type
- 3: All coordinate linear type

(Note) The movement method is as follows by the specified rotation axis type.

<Workpiece coordinate value>

- 0,1 : Display range 0° to 359.999°
- 2,3 : Display range 0° to ±99999.999°

<Machine coordinate value/relative position>

- 0,1,2 : Display range 0° to 359.999°
- 3 : Display range 0° to ±99999.999°

<ABS command>

- 0 : The incremental amount from the end point to the current position is divided by 360, and the axis moves by the remainder amount according to the sign.
- 1 : Moves with a short-cut to the end point.
- 2,3 : In the same manner as the normal linear axis, moves according to the sign by the amount obtained by subtracting the current position from the end point.

<INC command>

- 0,1,2,3 : Moves in the direction of the commanded sign by the commanded incremental amount starting at the current position.

<Reference position return>

- 0,1,2 : The movement to the middle point applies to the ABS command or the INC command. Returns with movement within 360 degrees from the middle point to reference position.
- 3 : The movement to the middle point applies to the ABS command or the INC command. Moves and returns in the reference position direction for the difference from the current position to the reference position.

This parameter is applicable to M730BM version B and above.

【#8214(PR)】 Rot ax spec select

Select a specification of linear type rotary axis.

This parameter is enabled only when "#8213 rotary axis type" is set to "2".

bit0: Display range selection for current position

- 0 : 0° to 359.999°
- 1 : 0° to ±99999.999°

bit1: Workpiece coordinate position display immediately after automatic reference position return

- 0: Round up to 360°
- 1: Not round up to 360°

---Setting range---

- 0 to 3
- bit1 bit0
- 0: 0 0
- 1: 0 1
- 2: 1 0
- 3: 1 1

< Setting example >

Display of current position is 0° to ±99999.999° and the workpiece coordinate position immediately after automatic reference position return is not rounded up to 360°: 3

【#8215】 TLM std length

Set the TLM standard length.
 TLM standard length is the distance from a tool replacement point (reference position) to the measurement basic point (surface) which is used to measure the tool length.
 (The same value as "#2016 tlm+" will be reflected. When either setting changes, the other will change accordingly.)

---Setting range---
 -99999.999 to 99999.999 (mm)

【#8216】 Type in G28 return

Select the performance after establishing the reference position in reference position return command.
 0: Moves to the reference position.
 1: Won't move to the reference position.

【#8222】 Chop comp coef

Set the coefficient to be applied to the compensation amount for the insufficient amount caused by servo delay during chopping.
 When 0 is set, the compensation will not be executed.

---Setting range---
 1 to 100 (%)

【#8223】 G10.6 retract amt

Set a retract amount when G10.6 of tool retract and return is independently commanded at tool retract and return 2.
 The axis retracts by the increment set for this parameter.
 This parameter is enabled only when the parameter #12047 is set to "1".
 (Note) When setting to the index table indexing axis (the axis for which "#2076 index_x" is set to "1"), "setting error" occurs.

---Setting range---
 -99999.999 to 99999.999 (mm)

【#8300】 P0 (for L system only)

Set the reference X-coordinates of the chuck and the tail stock barrier.
 Set the center coordinate (radius value) of workpiece by the basic machine coordinate system.

---Setting range---
 -99999.999 to 99999.999 (mm)

【#8301】 P1 (for L system only)

Set the area of the chuck and tail stock barrier.
 Set the coordinate from the center of workpiece (P0) for X-axis. (radius value)
 Set the coordinate value by basic machine coordinate system for Z-axis.

---Setting range---
 -99999.999 to 99999.999 (mm)

【#8302】 P2 (for L system only)

Set the area of the chuck and tail stock barrier.
 Set the coordinate from the center of workpiece (P0) for X-axis. (radius value)
 Set the coordinate value by basic machine coordinate system for Z-axis.

---Setting range---
 -99999.999 to 99999.999 (mm)

【#8303】 P3 (for L system only)

Set the area of the chuck and tail stock barrier.
 Set the coordinate from the center of workpiece (P0) for X-axis. (radius value)
 Set the coordinate value by basic machine coordinate system for Z-axis.

---Setting range---
 -99999.999 to 99999.999 (mm)

【#8304】 P4 (for L system only)

Set the area of the chuck and tail stock barrier.
 Set the coordinate from the center of workpiece (P0) for X-axis. (radius value)
 Set the coordinate value by basic machine coordinate system for Z-axis.

---Setting range---
 -99999.999 to 99999.999 (mm)

【#8305】 P5 (for L system only)

Set the area of the chuck and tail stock barrier.
 Set the coordinate from the center of workpiece (P0) for X-axis. (radius value)
 Set the coordinate value by basic machine coordinate system for Z-axis.

---Setting range---
 -99999.999 to 99999.999 (mm)

【#8306】 P6 (for L system only)

Set the area of the chuck and tail stock barrier.
 Set the coordinate from the center of workpiece (P0) for X-axis. (radius value)
 Set the coordinate value by basic machine coordinate system for Z-axis.

---Setting range---
 -99999.999 to 99999.999 (mm)

【#8310】 Barrier ON (for L system only)

Select whether to enable the chuck and tailstock barrier.
 0: Disable (Setting from special display unit will be enabled)
 1: Enable

【#8311】 P7 (for L system only)

Set the area of the left spindle section.
 Set the coordinate from the center of workpiece (P0) for X-axis. (radius value)
 Set the coordinate value by basic machine coordinate system for Z-axis.

---Setting range---
 -99999.999 to 99999.999 (mm)

【#8312】 P8 (for L system only)

Set the area of the left spindle section.
 Set the coordinate from the center of workpiece (P0) for X-axis. (radius value)
 Set the coordinate value by basic machine coordinate system for Z-axis.

---Setting range---
 -99999.999 to 99999.999 (mm)

【#8313】 P9 (for L system only)

Set the area of the right spindle section.
 X axis: Set the coordinate from the workpiece center (P0). (radius value)
 Z axis: Set the coordinates in the basic machine coordinate system.

---Setting range---
 -99999.999 to 99999.999 (mm)

【#8314】 P10 (for L system only)

Set the area of the right spindle section.
 Set the coordinate from the center of workpiece (P0) for X-axis. (radius value)
 Set the coordinate value by basic machine coordinate system for Z-axis.

---Setting range---
 -99999.999 to 99999.999 (mm)

【#8315】 Barrier Type (L) (for L system only)

Select the shape of the left chuck and tailstock barrier.
 0: No area
 1: Chuck
 2: Tailstock

【#8316】 Barrier Type (R) (for L system only)

Select the shape of the right chuck and tailstock barrier.
 0: No area
 1: Chuck
 2: Tailstock

【#8317】 ELIV. AX. Name (for L system only)

Set the name of the delivery axis when the right chuck and tailstock barrier is movable.
 When using the multi-part system method and the delivery axis is an axis in the other part system, designate the axis including the part system as 1A, 1B or 2A, 2B. If the part system is not designated as A and B, the set part system will be used.

---Setting range---
 A/B/.. (axis name)

 1A/1B/..
 2A/2B/.. (with part system designated)

 0: Cancel

【#8318】 Stock Angle (L) (for L system only)

Set the angle for the left tailstock end section.
 The angle will be interpreted as 90° if there is no setting (when "0" is set).

---Setting range---
 0 to 180 (°)
 0: 90° (default)

【#8319】 Stock Angle (R) (for L system only)

Set the angle for the right tailstock end section.
 The angle will be interpreted as 90° if there is no setting (when "0" is set).

---Setting range---
 0 to 180 (°)
 0: 90° (default)

【#8621】 Coord rot plane (H)

Not used. Set to "0".

【#8622】 Coord rot plane (V)

Not used. Set to "0".

【#8623】 Coord rot centr (H)

Not used. Set to "0".

【#8624】 Coord rot centr (V)

Not used. Set to "0".

【#8625】 Coord rot vctr (H)

Not used. Set to "0".

【#8626】 Coord rot vctr (V)

Not used. Set to "0".

【#8627】 Coord rot angle

Not used. Set to "0".

【#8701】 Tool length

Set the length to the touch tool tip.

---Setting range---

-99999.999 to 99999.999 (mm)

【#8702】 Tool Dia

Set the diameter of the sphere at the touch tool tip.

---Setting range---

-99999.999 to 99999.999 (mm)

【#8703】 OFFSET X

This sets the deviation amount (X direction) from the touch tool center to the spindle center.

---Setting range---

-99999.999 to 99999.999 (mm)

【#8704】 OFFSET Y

Set the deviation amount (Y direction) from the touch tool center to the spindle center.

---Setting range---

-99999.999 to 99999.999 (mm)

【#8705】 RETURN

Set the one-time return distance for contacting again.

---Setting range---

0 to 99999.999 (mm)

【#8706】 FEED

Set the feedrate when contacting again.

---Setting range---

1 to 60000 (mm/min)

【#8707】 Skip past amout (H)

Set the difference (horizontal axis direction) between the skip read value and actual skip position.

---Setting range---

-99999.999 to 99999.999 (mm)

【#8708】 Skip past amout (V)

Set the difference (vertical axis direction) between the skip read value and actual skip position.

---Setting range---

-99999.999 to 99999.999 (mm)

【#8711】 TLM L meas axis

Set the tool length measurement axis.
Set the "#1022 axname2" axis name.

---Setting range---

Axis name

(Note) If the axis name is illegal or not set, the 3rd axis name will be set as default.

【#8712】 TLM D meas axis

Set the tool diameter measurement axis.
Set the "#1022 axname2" axis name.

---Setting range---

Axis name

(Note) If the axis name is illegal or not set, the 1st axis name will be set as default.

【#8876】 M198 Pro spei :dev

Select a storage destination (device) for the subprogram.
M:Memory, G:HD, F:FD, R:Memory card, D:Data server

The subprogram is searched in the device selected with this parameter.

(Example) M198 P (program No.)

-> Search from :
the device of "#8877 Pro spei : dev"
the directory of "#8877 Pro spei : dir"

(Note 1) When the called subprogram is not found in the selected storage destination, a program error occurs.

(Note 2) When #8876 is not set, the subprogram registered in the data server (head directory) is searched.

(Note 3) When an invalid value is set to #8876, the program error (P232 No program No.) occurs.

(Note 4) When an unsupported drive name for #8876 is set, the program error (P232 No program No.) occurs.

【#8877】 M198 Pro spei :dir

Set a subprogram storage destination(directory).
The subprogram is searched in the device selected with this parameter.
Refer to "#8876 M198 Pro spei :dev".

---Setting range---

Directory 48 caractors

【#8879】 M198 Subpro stor

Select a device to search subprogram when a subprogram is called by M198 command.

0: CF card (NC)
1: CF card (NC)
2: Media (Panel computer)

【#8880】 Subpro stor D0: dev

Not used. Set to "0".

【#8881】 Subpro stor D0: dir

Not used. Set to "0".

【#8882】 Subpro stor D1: dev

Not used. Set to "0".

【#8883】 Subpro stor D1: dir

Not used. Set to "0".

【#8884】 Subbro stor D2: dev

Not used. Set to "0".

【#8885】 Subpro stor D2: dir

Not used. Set to "0".

【#8886】 Subbro stor D3: dev

Not used. Set to "0".

【#8887】 Subpro stor D3: dir

Not used. Set to "0".

【#8888】 Subbro stor D4: dev

Not used. Set to "0".

【#8889】 Subpro stor D4: dir

Not used. Set to "0".

【#8901】 Counter type 1

Not used. Set to "0".

【#8902】 Counter type 2

Not used. Set to "0".

【#8903】 Counter type 3

Not used. Set to "0".

【#8904】 Counter type 4

Not used. Set to "0".

【#8905】 Counter type 5

Not used. Set to "0".

【#8906】 Counter type 6

Not used. Set to "0".

【#8915】 Auto backup day 1

Not used. Set to "0".

【#8916】 Auto backup day 2

Not used. Set to "0".

【#8917】 Auto backup day 3

Not used. Set to "0".

【#8918】 Auto backup day 4

Not used. Set to "0".

【#8919】 Auto backup device

Not used. Set to "0".

【#8940】 Set select display

Not used. Set to "0".

【#19001】 Syn.tap(,S)cancel

0: Retain the spindle speed (,S) in synchronous tap return
 1: Cancel the spindle speed (,S) in synchronous tap return with G80
 The same value as "#1223 aux07/bit6" will be reflected. When either setting changes, the other will change accordingly.

【#19002】 Zero-point mark

Select the position for displaying the zero point mark in the graphic trace and 2D check.
 0: Machine coordinates zero point (same as conventional method)
 1: Workpiece coordinate zero point
 The same value as "#1231 set03/bit4" will be reflected. When either setting changes, the other will change accordingly.

【#19004】 Tap feedrate limit

Set the upper limit of the cutting feed rate in synchronous tapping.

---Setting range---

0 to 1000(mm/rev)

(Note)Setting "0" disables this parameter.

When the commanded cutting feed rate in synchronous tapping exceeds this setting, a program error (P184) will occur.

【#19005】 manual Fcmd2 clamp

Set a clamp speed coefficient (%) for manual speed command 2.
 The feed rate is clamped at the command feed rate or rapid traverse rate for automatic operation, which was multiplied by this parameter's value.
 (Note)This setting is valid only for manual speed command 2.

---Setting range---

0 to 1000 (%)
 0: 100% (Default value)

【#19418】 Arc inside min ovr

Set the minimum value of arc inside override.
 R1/R2 come close to zero and the tool feed stops when the radius of tool center path(R1) is very smaller than the radius of program path(R2).
 When this parameter is set and $R1/R2 \leq (\text{parameter setting value})$, tool feed is $F * (\text{parameter setting value})$.
 When this parameter is 0 or 100, the arc inside override is disabled.

---Setting range---

0 to 100 (%)

【#19425】 ManualB Std R1

Set a radius used as standard for the rotary axis speed.
 When the setting value of #19425 is larger than that of "#19427 ManualB Std R2", #19425 setting will be used as surface speed control standard radius 2: #19427 setting will be used as surface speed control standard radius 1.

---Setting range---

0 to 99999.999 (mm)

【#19426】 ManualB Std F1

This sets the rotary axis speed for surface speed control standard radius 1 (ManualB Std R1).
 When the setting value of #19426 is larger than that of "#19428 ManualB Std F2", #19426 setting will be used as surface speed control standard speed 2: #19427 setting will be used as surface speed control standard speed 1.

---Setting range---

1 to 1000000 (°/min)

【#19427】 ManualB Std R2

Set a radius used as standard for the rotary axis speed.

When the same value is set as "#19425 ManualB Std R1", the surface speed control standard speed 1 (ManualB Std F1) will be selected as the rotary axis speed if the radius is less than that value. The surface speed control standard speed 2 (ManualB Std F2) is selected if larger than the set value.

---Setting range---

0 to 99999.999 (mm)

【#19428】 ManualB Std F2

Set the rotary axis speed for surface speed control standard radius 2 (ManualB Std R2).

---Setting range---

1 to 1000000 (°/min)

2.2 I/O Parameters

The parameters with "(PR)" requires the CNC to be turned OFF after the settings. Turn the power OFF and ON to enable the parameter settings.

【#9001】 DATA IN

Select the port for inputting the data such as machine program and parameters.

- 1: ch1
- 2: ch2

【#9002】 DATA IN DEV.

Select the device No. for inputting the data. (The device Nos. correspond to the input/output device parameters.)

---Setting range---
0 to 4

【#9003】 DATA OUT

Select the port for outputting the data such as machine program and parameters.

- 1: ch1
- 2: ch2

【#9004】 DATA OUT DEV.

Select the device No. for outputting the data. (The device Nos. correspond to the input/output device parameters.)

---Setting range---
0 to 4

【#9005】 TAPE MODE

Select the input port for running with the tape mode.

- 1: ch1
- 2: ch2

【#9006】 TAPE MODE DEV.

Select the device No. to be run with the tape mode. (The device Nos. correspond to the input/output device parameters.)

---Setting range---
0 to 4

【#9007】 MACRO PRINT

Select the output port used for the user macro DPRINT command.

- 2: Output to serial port
- 6: Output to special display unit

【#9008】 MACRO PRINT DEV.

Select the device No. used for the DPRINT command. (The device Nos. correspond to the input/output device parameters.)

The setting of this parameter is invalid when "#9007" is set to "6". (Set the device number in special display unit.)

---Setting range---
0 to 4

【#9009】 PLC IN/OUT

Select the port for inputting/outputting various data with PLC.

- 1: ch1
- 2: ch2

【#9010】 PLC IN/OUT DEV.

Select the device No. used for the PLC input/output. (The device Nos. correspond to the input/output device parameters.)

---Setting range---
0 to 4

【#9011】 REMOTE PRG IN

Select the port for inputting remote programs.

1: ch1
2: ch2

【#9012】 REMOTE PRG IN DEV.

Select the device No. used to input remote programs. The device Nos. correspond to the input/output device parameters.

---Setting range---
0 to 4

【#9013】 EXT UNIT

Select the port for communication with an external unit.

1: ch1
2: ch2

【#9014】 EXT UNIT DEV.

Select the unit No. used for communication with an external unit(The unit Nos. correspond to the input/output device parameters.)

---Setting range---
0 to 4

【#9017】 HANDY TERMINAL PORT

Not used. Set to "0".

【#9018】 HANDY TERMINAL DEV.

Not used. Set to "0".

【#9019(PR)】 ModbusRTU con port

Select a port to connect with Modbus RTU.

1: ch1
2: ch2

【#9020(PR)】 ModbusRTU con dev

Select a device number to connect with Modbus RTU.

0 to 4

【#9101】 DEV0 DEVICE NAME

Set the device name corresponding to the device No.
Set a simple name for quick identification.

---Setting range---
Use alphabet characters, numerals and symbols to set a name within 3 characters.

【#9102】 DEVO BAUD RATE

Select the serial communication speed.

- 0: 19200 (bps)
- 1: 9600
- 2: 4800
- 3: 2400
- 4: 1200
- 5: 600
- 6: 300
- 7: 110

【#9103】 DEVO STOP BIT

Select the stop bit length used in the start-stop system.

Refer to "#9104 DEVO PARITY CHECK". At the output of data, the number of characters is always adjusted for the parity check.

- 1: 1 (bit)
- 2: 1.5
- 3: 2

【#9104】 DEVO PARITY CHECK

Select whether to add the parity check bit to the data.

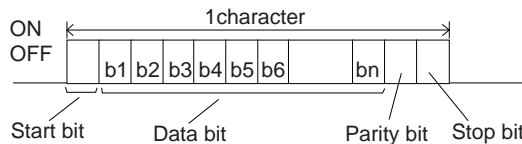

Set this parameter in accordance with the I/O device specifications.

- 0: Not add a parity bit in I/O mode
- 1: Add a parity bit in I/O mode

【#9105】 DEVO EVEN PARITY

Select odd or even when parity is added to the data. This parameter is ignored when no parity is added.

- 0: Odd parity
- 1: Even parity

【#9106】 DEVO CHR. LENGTH

Select the length of the data bit.

Refer to "#9104 DEVO PARITY CHECK".

- 0: 5 (bit)
- 1: 6
- 2: 7 (NC connection not supported)
- 3: 8

【#9107】 DEVO TERMINATR TYP

Select the code to terminate data reading.

- 0, 3: EOR
- 1, 2: EOB or EOR

【#9108】 DEVO HAND SHAKE

Select the transmission control method.

No handshaking will be used when a value except 1 to 3 is set.

- 1: RTS/CTS method
- 2: No handshaking
- 3: DC code method

【#9109】 DEVO DC CODE PRTY

Select the DC code type when the DC code method is selected.

- 0: Not add parity to DC code (DC3 = 13H)
- 1: Add parity to DC code (DC3 = 93H)

【#9111】 DEV0 DC2/4 OUTPUT

Select the DC code handling when outputting data to the output device.
DC2 / DC4
0: None / None
1: Yes / None
2: None / Yes
3: Yes / Yes

【#9112】 DEV0 CR OUTPUT

Select whether to add the (CR) code just before the EOB (L/F) code during output.
0: Not add
1: Add

【#9113】 DEV0 EIA OUTPUT

Select ISO or EIA code for data output.
In data input mode, the ISO and EIA codes are identified automatically.
0: ISO code output
1: EIA code output

【#9114】 DEV0 FEED CHR.

Set the length of the tape feed to be output at the start and end of the data during tape output.

---Setting range---
0 to 999 (characters)

【#9115】 DEV0 PARITY V

Select whether to perform the parity check for the number of characters in a block at the input of data.
At the output of data, the number of characters is always adjusted to for the parity check.
0: Not perform parity V check
1: Perform parity V check

【#9116】 DEV0 TIME-OUT (sec)

Set the time out time to detect an interruption in communication.
Time out check will not be executed when set to "0".

---Setting range---
0 to 30 (s)

【#9117】 DEV0 DR OFF

Select whether to enable the DR data check in data I/O mode.
0: Enable
1: Disable

【#9118】 DEV0 DATA ASCII

Select the code of the output data.
0: ISO/EIA code
(Depends on whether #9113, #9213, #9313, #9413 or #9513 EIA output parameter is set up.)
1: ASCII code

【#9119】 DEV0 INPUT TYPE

Select the mode for input (verification).
0: Standard input (Data from the very first EOB is handled as significant information.)
1: EOBs following the first EOB of the input data are skipped until data other than EOB is input

【#9120】 DEV0 OUT BUFFER

Select the buffer size of the output data which is output to output device using NC side serial port. If the output device has a data receiving error (overrun error), decrease the buffer size with this parameter.

If the buffer size is decreased, output time will prolong according to the size.

- 0: 250 bytes (default)
- 1: 1 byte
- 2: 4 bytes
- 3: 8 bytes
- 4: 16 bytes
- 5: 64 bytes

【#9121】 DEV0 EIA CODE [

Set the code in hexadecimal, which does not duplicate the existing EIA codes, for the special code "[".

When output with EIA code, data can be output using the alternate code in which the special ISO code, not included in EIA, is specified.

---Setting range---

0 to FF (hexadecimal)

【#9122】 DEV0 EIA CODE]

Set the code in hexadecimal, which does not duplicate the existing EIA codes, for the special code "]".

When output with EIA code, data can be output using the alternate code in which the special ISO code, not included in EIA, is specified.

---Setting range---

0 to FF (hexadecimal)

【#9123】 DEV0 EIA CODE #

Set the code in hexadecimal, which does not duplicate the existing EIA codes, for the special code "#".

When output with EIA code, data can be output using the alternate code in which the special ISO code, not included in EIA, is specified.

---Setting range---

0 to FF (hexadecimal)

【#9124】 DEV0 EIA CODE *

Set the code in hexadecimal, which does not duplicate the existing EIA codes, for the special code "*".

When output with EIA code, data can be output using the alternate code in which the special ISO code, not included in EIA, is specified.

---Setting range---

0 to FF (hexadecimal)

【#9125】 DEV0 EIA CODE =

Set the code in hexadecimal, which does not duplicate the existing EIA codes, for the special code "=".

When output with EIA code, data can be output using the alternate code in which the special ISO code, not included in EIA, is specified.

---Setting range---

0 to FF (hexadecimal)

【#9126】 DEV0 EIA CODE :

Set the code in hexadecimal, which does not duplicate the existing EIA codes, for the special code ":".

When output with EIA code, data can be output using the alternate code in which the special ISO code, not included in EIA, is specified.

---Setting range---

0 to FF (hexadecimal)

【#9127】 DEV0 EIA CODE \$

Set the code in hexadecimal, which does not duplicate the existing EIA codes, for the special code "\$".

When output with EIA code, data can be output using the alternate code in which the special ISO code, not included in EIA, is specified.

---Setting range---

0 to FF (hexadecimal)

【#9128】 DEV0 EIA CODE !

Set the code in hexadecimal, which does not duplicate the existing EIA codes, for the special code "!".

When output with EIA code, data can be output using the alternate code in which the special ISO code, not included in EIA, is specified.

---Setting range---

0 to FF (hexadecimal)

【#9201】 DEV1 DEVICE NAME

Set the device name corresponding to the device No.
Set a simple name for quick identification.

---Setting range---

Use alphabet characters, numerals and symbols to set a name within 3 characters.

【#9202】 DEV1 BAUD RATE

Select the serial communication speed.

0: 19200 (bps)

1: 9600

2: 4800

3: 2400

4: 1200

5: 600

6: 300

7: 110

【#9203】 DEV1 STOP BIT

Select the stop bit length used in the start-stop system.

Refer to "#9204 DEV1 PARITY CHECK". At the output of data, the number of characters is always adjusted to for the parity check.

1: 1 (bit)

2: 1.5

3: 2

【#9204】 DEV1 PARITY CHECK

Select whether to add a parity check bit to the data.

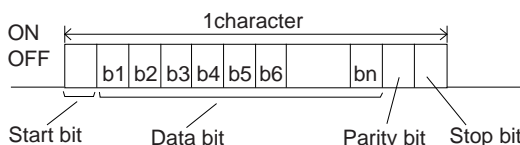

Set this parameter in accordance with the I/O device specifications.

0: Not add a parity bit in I/O mode

1: Add a parity bit in I/O mode

【#9205】 DEV1 EVEN PARITY

Select whether even or odd parity will be used when parity is used. This parameter is ignored when no parity is added.

0: Odd parity

1: Even parity

【#9206】 DEV1 CHR. LENGTH

Select the length of the data bit.
 Refer to "#9204 DEV1 PARITY CHECK".
 0: 5 (bit)
 1: 6
 2: 7 (NC connection not supported)
 3: 8

【#9207】 DEV1 TERMINATR TYP

Select the code to terminate data reading.
 0, 3: EOR
 1, 2: EOB or EOR

【#9208】 DEV1 HAND SHAKE

Select the transmission control method.
 No handshaking will be used when a value except 1 to 3 is set.
 1: RTS/CTS method
 2: No handshaking
 3: DC code method

【#9209】 DEV1 DC CODE PRTY

Select the DC code type when the DC code method is selected.
 0: Not add parity to DC code (DC3 = 13H)
 1: Add parity to DC code (DC3 = 93H)

【#9211】 DEV1 DC2/4 OUTPUT

Select the DC code handling when outputting data to the output device.
 DC2 / DC4
 0: None / None
 1: Yes / None
 2: None / Yes
 3: Yes / Yes

【#9212】 DEV1 CR OUTPUT

Select whether to add the (CR) code just before the EOB (L/F) code during output.
 0: Not add
 1: Add

【#9213】 DEV1 EIA OUTPUT

Select ISO or EIA code for data output.
 In data input mode, the ISO and EIA codes are identified automatically.
 0: ISO code output
 1: EIA code output

【#9214】 DEV1 FEED CHR.

Set the length of the tape feed to be output at the start and end of the data during tape output.

---Setting range---
 0 to 999 (characters)

【#9215】 DEV1 PARITY V

Select whether to perform the parity check for the number of characters in a block at the input of data.
 At the output of data, the number of characters is always adjusted to for the parity check.
 0: Not perform parity V check
 1: Perform parity V check

【#9216】 DEV1 TIME-OUT (sec)

Set the time out time to detect an interruption in communication.
Time out check will not be executed when set to "0".

---Setting range---
0 to 30 (s)

【#9217】 DEV1 DR OFF

Select whether to enable the DR data check in data I/O mode.
0: Enable
1: Disable

【#9218】 DEV1 DATA ASCII

Select the code of the output data.
0: ISO/EIA code
(Depends on whether #9113, #9213, #9313, #9413 or #9513 EIA output parameter is set up.)
1: ASCII code

【#9219】 DEV1 INPUT TYPE

Select the mode for input (verification).
0: Standard input (Data from the very first EOB is handled as significant information.)
1: EOBs following the first EOB of the input data are skipped until data other than EOB is input

【#9220】 DEV1 OUT BUFFER

Select the buffer size of the output data which is output to output device using NC side serial port.
If the output device has a transmission error (overrun error), decrease the buffer size with this parameter.
If the buffer size is decreased, output time will prolong according to the size.
0: 250 bytes (default)
1: 1 byte
2: 4 byte
3: 8 byte
4: 16 byte
5: 64 byte

【#9221】 DEV1 EIA CODE [

Set the code in hexadecimal, which does not duplicate the existing EIA codes, for the special code "[".
When output with EIA code, data can be output using the alternate code in which the special ISO code, not included in EIA, is specified.

---Setting range---
0 to FF (hexadecimal)

【#9222】 DEV1 EIA CODE]

Set the code in hexadecimal, which does not duplicate the existing EIA codes, for the special code "]".
When output with EIA code, data can be output using the alternate code in which the special ISO code, not included in EIA, is specified.

---Setting range---
0 to FF (hexadecimal)

【#9223】 DEV1 EIA CODE #

Set the code in hexadecimal, which does not duplicate the existing EIA codes, for the special code "#".
When output with EIA code, data can be output using the alternate code in which the special ISO code, not included in EIA, is specified. .

---Setting range---
0 to FF (hexadecimal)

【#9224】 DEV1 EIA CODE *

Set the code in hexadecimal, which does not duplicate the existing EIA codes, for the special code "*".

When output with EIA code, data can be output using the alternate code in which the special ISO code, not included in EIA, is specified.

---Setting range---

0 to FF (hexadecimal)

【#9225】 DEV1 EIA CODE =

Set the code in hexadecimal, which does not duplicate the existing EIA codes, for the special code "=".

When output with EIA code, data can be output using the alternate code in which the special ISO code, not included in EIA, is specified.

---Setting range---

0 to FF (hexadecimal)

【#9226】 DEV1 EIA CODE :

Set the code in hexadecimal, which does not duplicate the existing EIA codes, for the special code ":".

When output with EIA code, data can be output using the alternate code in which the special ISO code, not included in EIA, is specified.

---Setting range---

0 to FF (hexadecimal)

【#9227】 DEV1 EIA CODE \$

Set the code in hexadecimal, which does not duplicate the existing EIA codes, for the special code "\$".

When output with EIA code, data can be output using the alternate code in which the special ISO code, not included in EIA, is specified.

---Setting range---

0 to FF (hexadecimal)

【#9228】 DEV1 EIA CODE !

Set the code in hexadecimal, which does not duplicate the existing EIA codes, for the special code "!".

When output with EIA code, data can be output using the alternate code in which the special ISO code, not included in EIA, is specified.

---Setting range---

0 to FF (hexadecimal)

【#9301】 DEV2 DEVICE NAME

Set the device name corresponding to the device No.

Set a simple name for quick identification.

---Setting range---

Use alphabet characters, numerals and symbols to set a name within 3 characters.

【#9302】 DEV2 BAUD RATE

Select the serial communication speed.

0: 19200 (bps)

1: 9600

2: 4800

3: 2400

4: 1200

5: 600

6: 300

7: 110

【#9303】 DEV2 STOP BIT

Select the stop bit length used in the start-stop system.
Refer to "#9304 DEV2 PARITY CHECK". At the output of data, the number of characters is always adjusted to for the parity check.

- 1: 1 (bit)
- 2: 1.5
- 3: 2

【#9304】 DEV2 PARITY CHECK

Select whether to add a parity check bit to the data.

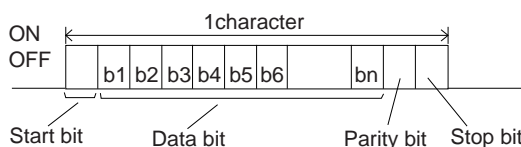

Set this parameter in accordance with the I/O device specifications.

- 0: Not add a parity bit in I/O mode
- 1: Add a parity bit in I/O mode

【#9305】 DEV2 EVEN PARITY

Select whether even or odd parity will be used when parity is used. This parameter is ignored when no parity is added.

- 0: Odd parity
- 1: Even parity

【#9306】 DEV2 CHR. LENGTH

Select the length of the data bit.
Refer to "#9304 DEV2 PARITY CHECK".

- 0: 5 (bit)
- 1: 6
- 2: 7 (NC connection not supported)
- 3: 8

【#9307】 DEV2 TERMINATR TYP

Select the code to terminate data reading.

- 0, 3: EOR
- 1, 2: EOB or EOR

【#9308】 DEV2 HAND SHAKE

Select the transmission control method.
No handshaking will be used when a value except 1 to 3 is set.

- 1: RTS/CTS method
- 2: No handshaking
- 3: DC code method

【#9309】 DEV2 DC CODE PRY

Select the DC code type when the DC code method is selected.

- 0: Not add parity to DC code (DC3 = 13H)
- 1: Add parity to DC code (DC3 = 93H)

【#9311】 DEV2 DC2/4 OUTPUT

Select the DC code handling when outputting data to the output device.

- DC2 / DC4
- 0: None / None
- 1: Yes / None
- 2: None / Yes
- 3: Yes / Yes

【#9312】 DEV2 CR OUTPUT

Select whether to add the (CR) code just before the EOB (L/F) code during output.
 0: Not add
 1: Add

【#9313】 DEV2 EIA OUTPUT

Select ISO or EIA code for data output.
 In data input mode, the ISO and EIA codes are identified automatically.
 0: ISO code output
 1: EIA code output

【#9314】 DEV2 FEED CHR.

Set the length of the tape feed to be output at the start and end of the data during tape output.

---Setting range---
 0 to 999 (characters)

【#9315】 DEV2 PARITY V

Select whether to perform the parity check for the number of characters in a block at the input of data.
 At the output of data, the number of characters is always adjusted to for the parity check.
 0: Not perform parity V check
 1: Perform parity V check

【#9316】 DEV2 TIME-OUT (sec)

Set the time out time to detect an interruption in communication.
 Time out check will not be executed when set to "0".

---Setting range---
 0 to 30 (s)

【#9317】 DEV2 DR OFF

Select whether to enable the DR data check in data I/O mode.
 0: Enable
 1: Disable

【#9318】 DEV2 DATA ASCII

Select the code of the output data.
 0: ISO/EIA code
 (Depends on whether #9113, #9213, #9313, #9413 or #9513 EIA output parameter is set up.)
 1: ASCII code

【#9319】 DEV2 INPUT TYPE

Select the mode for input (verification).
 0: Standard input (Data from the very first EOB is handled as significant information.)
 1: EOBs following the first EOB of the input data are skipped until data other than EOB is input

【#9320】 DEV2 OUT BUFFER

Select the buffer size of the output data which is output to output device using NC side serial port.
 If the output device has a transmission error (overrun error), decrease the buffer size with this parameter.
 If the buffer size is decreased, output time will prolong according to the size.
 0: 250 bytes (default)
 1: 1 byte
 2: 4 byte
 3: 8 byte
 4: 16 byte
 5: 64 byte

【#9321】 DEV2 EIA CODE [

Set the code in hexadecimal, which does not duplicate the existing EIA codes, for the special code "[".
When output with EIA code, data can be output using the alternate code in which the special ISO code, not included in EIA, is specified.

---Setting range---
0 to FF (hexadecimal)

【#9322】 DEV2 EIA CODE]

Set the code in hexadecimal, which does not duplicate the existing EIA codes, for the special code "]" ".
When output with EIA code, data can be output using the alternate code in which the special ISO code, not included in EIA, is specified.

---Setting range---
0 to FF (hexadecimal)

【#9323】 DEV2 EIA CODE #

Set the code in hexadecimal, which does not duplicate the existing EIA codes, for the special code "#".
When output with EIA code, data can be output using the alternate code in which the special ISO code, not included in EIA, is specified.

---Setting range---
0 to FF (hexadecimal)

【#9324】 DEV2 EIA CODE *

Set the code in hexadecimal, which does not duplicate the existing EIA codes, for the special code "*".
When output with EIA code, data can be output using the alternate code in which the special ISO code, not included in EIA, is specified.

---Setting range---
0 to FF (hexadecimal)

【#9325】 DEV2 EIA CODE =

Set the code in hexadecimal, which does not duplicate the existing EIA codes, for the special code "= ".
When output with EIA code, data can be output using the alternate code in which the special ISO code, not included in EIA, is specified.

---Setting range---
0 to FF (hexadecimal)

【#9326】 DEV2 EIA CODE :

Set the code in hexadecimal, which does not duplicate the existing EIA codes, for the special code ":" ".
When output with EIA code, data can be output using the alternate code in which the special ISO code, not included in EIA, is specified.

---Setting range---
0 to FF (hexadecimal)

【#9327】 DEV2 EIA CODE \$

Set the code in hexadecimal, which does not duplicate the existing EIA codes, for the special code "\$".
When output with EIA code, data can be output using the alternate code in which the special ISO code, not included in EIA, is specified.

---Setting range---
0 to FF (hexadecimal)

【#9328】 DEV2 EIA CODE !

Set the code in hexadecimal, which does not duplicate the existing EIA codes, for the special code "!".

When output with EIA code, data can be output using the alternate code in which the special ISO code, not included in EIA, is specified.

---Setting range---

0 to FF (hexadecimal)

【#9401】 DEV3 DEVICE NAME

Set the device name corresponding to the device No.

Set a simple name for quick identification.

---Setting range---

Use alphabet characters, numerals and symbols to set a name within 3 characters.

【#9402】 DEV3 BAUD RATE

Select the serial communication speed.

0: 19200 (bps)

1: 9600

2: 4800

3: 2400

4: 1200

5: 600

6: 300

7: 110

【#9403】 DEV3 STOP BIT

Select the stop bit length used in the start-stop system.

Refer to "#9404 DEV3 PARITY CHECK". At the output of data, the number of characters is always adjusted to for the parity check.

1: 1 (bit)

2: 1.5

3: 2

【#9404】 DEV3 PARITY CHECK

Select whether to add a parity check bit to the data.

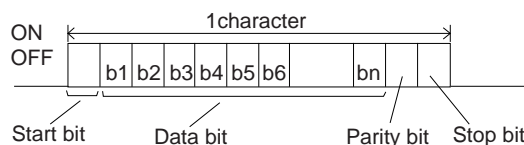

Set this parameter in accordance with the I/O device specifications.

0: Not add a parity bit in I/O mode

1: Add a parity bit in I/O mode

【#9405】 DEV3 EVEN PARITY

Select whether even or odd parity will be used when parity is used. This parameter is ignored when no parity is added.

0: Odd parity

1: Even parity

【#9406】 DEV3 CHR. LENGTH

Select the length of the data bit.

Refer to "#9404 DEV3 PARITY CHECK".

0: 5 (bit)

1: 6

2: 7 (NC connection not supported)

3: 8

【#9407】 DEV3 TERMINATR TYP

Select the code to terminate data reading.

- 0, 3: EOR
- 1, 2: EOB or EOR

【#9408】 DEV3 HAND SHAKE

Select the transmission control method.

No handshaking will be used when a value except 1 to 3 is set.

- 1: RTS/CTS method
- 2: No handshaking
- 3: DC code method

【#9409】 DEV3 DC CODE PRTY

Select the DC code type when the DC code method is selected.

- 0: Not add parity to DC code (DC3 = 13H)
- 1: Add parity to DC code (DC3 = 93H)

【#9411】 DEV3 DC2/4 OUTPUT

Select the DC code handling when outputting data to the output device.

- DC2 / DC4
- 0: None / None
- 1: Yes / None
- 2: None / Yes
- 3: Yes / Yes

【#9412】 DEV3 CR OUTPUT

Select whether to add the (CR) code just before the EOB (L/F) code during output.

- 0: Not add
- 1: Add

【#9413】 DEV3 EIA OUTPUT

Select ISO or EIA code for data output.

In data input mode, the ISO and EIA codes are identified automatically.

- 0: ISO code output
- 1: EIA code output

【#9414】 DEV3 FEED CHR.

Set the length of the tape feed to be output at the start and end of the data during tape output.

---Setting range---

- 0 to 999 (characters)

【#9415】 DEV3 PARITY V

Select whether to perform the parity check for the number of characters in a block at the input of data.

At the output of data, the number of characters is always adjusted to for the parity check.

- 0: Not perform parity V check
- 1: Perform parity V check

【#9416】 DEV3 TIME-OUT (sec)

Set the time out time to detect an interruption in communication.

Time out check will not be executed when set to "0".

---Setting range---

- 0 to 30 (s)

【#9417】 DEV3 DR OFF

Select whether to enable the DR data check in data I/O mode.

- 0: Enable
- 1: Disable

【#9418】 DEV3 DATA ASCII

Select the code of the output data.

0: ISO/EIA code

(Depends on whether #9113, #9213, #9313, #9413 or #9513 EIA output parameter is set up.)

1: ASCII code

【#9419】 DEV3 INPUT TYPE

Select the mode for input (verification).

0: Standard input (Data from the very first EOB is handled as significant information.)

1: EOBs following the first EOB of the input data are skipped until data other than EOB is input.

【#9420】 DEV3 OUT BUFFER

Select the buffer size of the output data which is output to output device using NC side serial port. If the output device has a data receiving error (overrun error), decrease the buffer size with this parameter.

If the buffer size is decreased, output time will prolong according to the size.

0: 250 bytes (default)

1: 1 byte

2: 4 bytes

3: 8 bytes

4: 16 bytes

5: 64 bytes

【#9421】 DEV3 EIA CODE [

Set the code in hexadecimal, which does not duplicate the existing EIA codes, for the special code "[".

When output with EIA code, data can be output using the alternate code in which the special ISO code, not included in EIA, is specified.

---Setting range---

0 to FF (hexadecimal)

【#9422】 DEV3 EIA CODE]

Set the code in hexadecimal, which does not duplicate the existing EIA codes, for the special code "]".

When output with EIA code, data can be output using the alternate code in which the special ISO code, not included in EIA, is specified.

---Setting range---

0 to FF (hexadecimal)

【#9423】 DEV3 EIA CODE #

Set the code in hexadecimal, which does not duplicate the existing EIA codes, for the special code "#".

When output with EIA code, data can be output using the alternate code in which the special ISO code, not included in EIA, is specified.

---Setting range---

0 to FF (hexadecimal)

【#9424】 DEV3 EIA CODE *

Set the code in hexadecimal, which does not duplicate the existing EIA codes, for the special code "*".

When output with EIA code, data can be output using the alternate code in which the special ISO code, not included in EIA, is specified.

---Setting range---

0 to FF (hexadecimal)

【#9425】 DEV3 EIA CODE =

Set the code in hexadecimal, which does not duplicate the existing EIA codes, for the special code "=".

When output with EIA code, data can be output using the alternate code in which the special ISO code, not included in EIA, is specified.

---Setting range---

0 to FF (hexadecimal)

【#9426】 DEV3 EIA CODE :

Set the code in hexadecimal, which does not duplicate the existing EIA codes, for the special code ":".

When output with EIA code, data can be output using the alternate code in which the special ISO code, not included in EIA, is specified.

---Setting range---

0 to FF (hexadecimal)

【#9427】 DEV3 EIA CODE \$

Set the code in hexadecimal, which does not duplicate the existing EIA codes, for the special code "\$".

When output with EIA code, data can be output using the alternate code in which the special ISO code, not included in EIA, is specified.

---Setting range---

0 to FF (hexadecimal)

【#9428】 DEV3 EIA CODE !

Set the code in hexadecimal, which does not duplicate the existing EIA codes, for the special code "!".

When output with EIA code, data can be output using the alternate code in which the special ISO code, not included in EIA, is specified.

---Setting range---

0 to FF (hexadecimal)

【#9501】 DEV4 DEVICE NAME

Set the device name corresponding to the device No.

Set a simple name for quick identification.

---Setting range---

Use alphabet characters, numerals and symbols to set a name within 3 characters.

【#9502】 DEV4 BAUD RATE

Select the serial communication speed.

0: 19200 (bps)

1: 9600

2: 4800

3: 2400

4: 1200

5: 600

6: 300

7: 110

【#9503】 DEV4 STOP BIT

Select the stop bit length used in the start-stop system.

Refer to "#9504 DEV4 PARITY CHECK". At the output of data, the number of characters is always adjusted to for the parity check.

1: 1 (bit)

2: 1.5

3: 2

【#9504】 DEV4 PARITY CHECK

Select whether to add a parity check bit to the data.

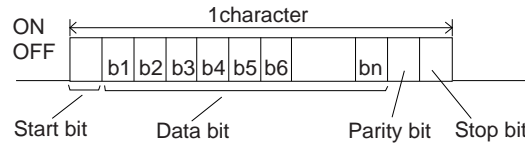

Set this parameter in accordance with the I/O device specifications.

- 0: Not add a parity bit in I/O mode
- 1: Add a parity bit in I/O mode

【#9505】 DEV4 EVEN PARITY

Select whether even or odd parity will be used when parity is used. This parameter is ignored when no parity is added.

- 0: Odd parity
- 1: Even parity

【#9506】 DEV4 CHR. LENGTH

Select the length of the data bit.
Refer to "#9504 DEV4 PARITY CHECK".

- 0: 5 (bit)
- 1: 6
- 2: 7 (NC connection not supported)
- 3: 8

【#9507】 DEV4 TERMINATR TYP

Select the code to terminate data reading.

- 0, 3: EOR
- 1, 2: EOB or EOR

【#9508】 DEV4 HAND SHAKE

Select the transmission control method.
No handshaking will be used when a value except 1 to 3 is set.

- 1: RTS/CTS method
- 2: No handshaking
- 3: DC code method

【#9509】 DEV4 DC CODE PRTY

Select the DC code type when the DC code method is selected.

- 0: Not add parity to DC code (DC3 = 13H)
- 1: Add parity to DC code (DC3 = 93H)

【#9511】 DEV4 DC2/4 OUTPUT

Select the DC code handling when outputting data to the output device.

- DC2 / DC4
- 0: None / None
- 1: Yes / None
- 2: None / Yes
- 3: Yes / Yes

【#9512】 DEV4 CR OUTPUT

Select whether to add the (CR) code just before the EOB (L/F) code during output.

- 0: Not add
- 1: Add

【#9513】 DEV4 EIA OUTPUT

Select ISO or EIA code for data output.
In data input mode, the ISO and EIA codes are identified automatically.

- 0: ISO code output
- 1: EIA code output

【#9514】 DEV4 FEED CHR.

Set the length of the tape feed to be output at the start and end of the data during tape output.

---Setting range---

0 to 999 (characters)

【#9515】 DEV4 PARITY V

Select whether to perform the parity check for the number of characters in a block at the input of data.

At the output of data, the number of characters is always adjusted to for the parity check.

0: Not perform parity V check

1: Perform parity V check

【#9516】 DEV4 TIME-OUT (sec)

Set the time out time to detect an interruption in communication.

Time out check will not be executed when set to "0".

---Setting range---

0 to 30 (s)

【#9517】 DEV4 DR OFF

Select whether to enable the DR data check in data I/O mode.

0: Enable

1: Disable

【#9518】 DEV4 DATA ASCII

Select the code of the output data.

0: ISO/EIA code

(Depends on whether #9113, #9213, #9313, #9413 or #9513 EIA output parameter is set up.)

1: ASCII code

【#9519】 DEV4 INPUT TYPE

Select the mode for input (verification).

0: Standard input (Data from the very first EOB is handled as significant information.)

1: EOBs following the first EOB of the input data are skipped until data other than EOB is input.

【#9520】 DEV4 OUT BUFFER

Select the buffer size of the output data which is output to output device using NC side serial port. If the output device has a transmission error (overrun error), decrease the buffer size with this parameter.

If the buffer size is decreased, output time will prolong according to the size.

0: 250 bytes (default)

1: 1 byte

2: 4 byte

3: 8 byte

4: 16 byte

5: 64 byte

【#9521】 DEV4 EIA CODE [

Set the code in hexadecimal, which does not duplicate the existing EIA codes, for the special code "[

When output with EIA code, data can be output using the alternate code in which the special ISO code, not included in EIA, is specified.

---Setting range---

0 to FF (hexadecimal)

【#9522】 DEV4 EIA CODE]

Set the code in hexadecimal, which does not duplicate the existing EIA codes, for the special code "]".

When output with EIA code, data can be output using the alternate code in which the special ISO code, not included in EIA, is specified.

---Setting range---

0 to FF (hexadecimal)

【#9523】 DEV4 EIA CODE #

Set the code in hexadecimal, which does not duplicate the existing EIA codes, for the special code "#".

When output with EIA code, data can be output using the alternate code in which the special ISO code, not included in EIA, is specified.

---Setting range---

0 to FF (hexadecimal)

【#9524】 DEV4 EIA CODE *

Set the code in hexadecimal, which does not duplicate the existing EIA codes, for the special code "*".

When output with EIA code, data can be output using the alternate code in which the special ISO code, not included in EIA, is specified.

---Setting range---

0 to FF (hexadecimal)

【#9525】 DEV4 EIA CODE =

Set the code in hexadecimal, which does not duplicate the existing EIA codes, for the special code "=".

When output with EIA code, data can be output using the alternate code in which the special ISO code, not included in EIA, is specified.

---Setting range---

0 to FF (hexadecimal)

【#9526】 DEV4 EIA CODE :

Set the code in hexadecimal, which does not duplicate the existing EIA codes, for the special code ":".

When output with EIA code, data can be output using the alternate code in which the special ISO code, not included in EIA, is specified.

---Setting range---

0 to FF (hexadecimal)

【#9527】 DEV4 EIA CODE \$

Set the code in hexadecimal, which does not duplicate the existing EIA codes, for the special code "\$".

When output with EIA code, data can be output using the alternate code in which the special ISO code, not included in EIA, is specified.

---Setting range---

0 to FF (hexadecimal)

【#9528】 DEV4 EIA CODE !

Set the code in hexadecimal, which does not duplicate the existing EIA codes, for the special code "!".

When output with EIA code, data can be output using the alternate code in which the special ISO code, not included in EIA, is specified.

---Setting range---

0 to FF (hexadecimal)

【#9601】 BAUD RATE

Select the rate at which data is transferred.

- 0: 19200 (bps)
- 1: 9600
- 2: 4800
- 3: 2400
- 4: 1200
- 5: 600
- 6: 300
- 7: 110
- 8: 38400

【#9602】 STOP BIT

Select the stop bit length used in the start-stop system.

Refer to "#9603 PARITY EFFECTIVE". At the output of data, the number of characters is always adjusted to for the parity check.

- 1: 1 (bit)
- 2: 1.5
- 3: 2

【#9603】 PARITY EFFECTIVE

Select whether to add the parity bit to the data.

The parameter is set when using a parity bit separately from the data bit.

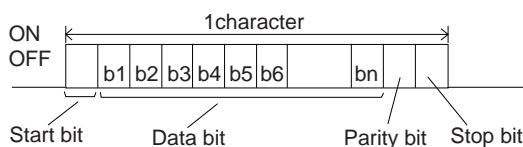

Set this parameter according to the specifications of input/output device.

- 0: Not add a parity bit at the input/output
- 1: Add a parity bit at the input/output

【#9604】 EVEN PARITY

Select odd or even when parity is added to the data. This parameter is ignored when no parity is added.

- 0: Odd parity
- 1: Even parity

【#9605】 CHR. LENGTH

Select the length of the data bit.

Refer to "#9603 PARITY EFFECTIVE".

- 2: 7
- 3: 8

【#9606】 HAND SHAKE

Select the transmission control method.

"3" (DC code method) should be set for computer link B.

- 0: No control
- 1: RTS/CTS method
- 2: No handshaking
- 3: DC code method

【#9607】 TIME-OUT SET

Set the time-out time at which an interruption of data transfer during data input/output should be detected.

"0" means infinite time-out.

---Setting range---

- 0 to 999 (1/10s)

【#9608】 DATA CODE

Set the code to be used for the data description.
Refer to "#9603 PARITY EFFECTIVE".
0: ASCII code
1: ISO code

【#9609】 LINK PARAM. 1**bit1: DC1 output after NAK or SYN**

Select whether to output the DC1 code after the NAK or SYN code is output.
0: Not output the DC1 code.
1: Output the DC1 code.

bit7: Enable/disable resetting

Select whether to enable the resetting in the computer link.
0: Enable
1: Disable

【#9610】 LINK PARAM. 2**Bit 2: Specify the control code parity (even parity for the control code).**

Select whether to add an even parity to the control code, in accordance with the I/O device specifications.
0: Not add a parity bit to the control code
1: Add a parity bit to the control code

Bit 3: Parity V

Select whether to enable checking of parity V in one block at the input of the data.
0: Disable
1: Enable

【#9611】 Link PARAM. 3

Not used. Set to "0".

【#9612】 Link PARAM. 4

Not used. Set to "0".

【#9613】 Link PARAM. 5

Not used. Set to "0".

【#9614】 START CODE

Select the code used to command the first transfer of file data.
This parameter is used for a specific user. Normally set "0".
0: DC1 (11H)
1: BEL (07H)

【#9615】 CTRL. CODE OUT**bit 0: NAK output**

Select whether to send the NAK code to the host if a communication error occurs in computer link B.
0: Not output the NAK code
1: Output the NAK code.

bit 1: SYN output

Select whether to send the SYN code to the host if NC resetting or an emergency stop occurs in computer link B.
0: Not output the SYN code.
1: Output the SYN code.

bit 3: DC3 output

Select whether to send the DC3 code to the host when the communication ends in computer link B.
0: Not output the DC3 code.
1: Output the DC3 code.

【#9616】 CTRL. INTERVAL

Not used. Set to "0".

【#9617】 WAIT TIME

Not used. Set to "0".

【#9618】 PACKET LENGTH

Not used. Set to "0".

【#9619】 BUFFER SIZE

Not used. Set to "0".

【#9620】 START SIZE

Not used. Set to "0".

【#9621】 DC1 OUT SIZE

Not used. Set to "0".

【#9622】 POLLING TIMER

Not used. Set to "0".

【#9623】 TRANS. WAIT TMR

Not used. Set to "0".

【#9624】 RETRY COUNTER

Not used. Set to "0".

【#9701(PR)】 IP addr auto set

Not used. Set to "0".

【#9706】 Host No.

Select the No. of the host to be used from host 1 to host 4.

---Setting range---

1 to 4 : Host No.

【#9711】 Host1 host name

Set the host computer name.

This parameter allows the NC to easily recognize the host computer on the network. Set the host computer's name (name registered in C:\windows\hosts) or the IP address.

<Setting example>

For host name: mspc160

For IP address: 150.40.0.111

(Note) Set the host computer's TCP/IP address if communication is not carried out correctly.

---Setting range---

15 characters (alphanumeric) or less

【#9712】 Host1 user name

Set the user name when logging into the host computer.

---Setting range---

15 characters (alphanumeric) or less

【#9713】 Host1 password

Set the password when logging into the host computer.

---Setting range---

15 characters (alphanumeric) or less

【#9714】 Host1 directory

Set the directory name of the host computer.

The directory released to the client (NC unit) with the host computer's server is handled as root directory by the NC unit.

---Setting range---

31 characters (alphanumeric) or less

【#9715】 Host1 host type

Select the type of the host computer.

0: UNIX/PC automatic judgment

1: UNIX

2: PC (DOS)

(Note) When "0" is set, the settings for the following parameters will be invalid.

- #9716 Wrd pos: name

- #9717 Wrd pos: size

- #9718 Wrd pos: Dir

- #9719 Wrd pos: cmnt

- #9720 Wrd num: cmnt

【#9716】 Host 1 Wrd pos: name

Set the file name display position (nth word from left) of the list displayed when the ftp command "dir" is executed.

(Note) One word designates a character string divided by one or more spaces.

---Setting range---

0 to 100

0: Default value

【#9717】 Host 1 Wrd pos: size

Set the size display position (nth word from left) of the list displayed when the ftp command "dir" is executed.

(Note) One word designates a character string divided by one or more spaces.

---Setting range---

0 to 100

0: Default value

【#9718】 Host 1 Wrd pos: Dir

Set the <DIR> display position (nth word from left) of the list displayed when the ftp command "dir" is executed.

(Note) One word designates a character string divided by one or more spaces.

---Setting range---

0 to 100

0: Default value

【#9719】 Host 1 Wrd pos: cmnt

Set the comment (date, time, etc.) display position (nth word from left) of the list displayed when the ftp command "dir" is executed.

(Note) One word designates a character string divided by one or more spaces.

---Setting range---

0 to 100

0: Default value

【#9720】 Host 1 Wrd num: cmnt

Set the number of words to be displayed as a comment.

(Note) One word designates a character string divided by one or more spaces.

---Setting range---

0 to 100

0: Default value

【#9721】 Host 1 no total siz

Set whether to display the total number of characters registered in the machining programs of host1 when displaying the file list.

If there are many files in the directory to be referred to, the list can be updated quickly by setting "1".

0: Display

1: Not display

【#9731】 Host2 host name

Set the host computer name.

This parameter allows the NC to easily recognize the host computer on the network. Set the host computer's name (name registered in C:\windows\hosts) or the IP address.

<Setting example>

For host name: mspc160

For IP address: 150.40.0.111

(Note) Set the host computer's TCP/IP address if communication is not carried out correctly.

---Setting range---

15 characters (alphanumeric) or less

【#9732】 Host2 user name

Set the user name when logging into the host computer.

---Setting range---

15 characters (alphanumeric) or less

【#9733】 Host2 password

Set the password when logging into the host computer.

---Setting range---

15 characters (alphanumeric) or less

【#9734】 Host2 directory

Set the directory name of the host computer.

The directory released to the client (NC unit) with the host computer's server is handled as the root directory by the NC unit.

---Setting range---

31 characters (alphanumeric) or less

【#9735】 Host2 host type

Select the type of the host computer.

- 0: UNIX/PC automatic judgment
- 1: UNIX
- 2: PC (DOS)

(Note) When "0" is set, the settings for the following parameters will be invalid.

- #9736 Wrd pos: name
- #9737 Wrd pos: size
- #9738 Wrd pos: Dir
- #9739 Wrd pos: cmnt
- #9740 Wrd num: cmnt

【#9736】 Host 2 Wrd pos: name

Set the file name display position (nth word from left) of the list displayed when the ftp command "dir" is executed.

(Note) One word designates a character string divided by one or more spaces.

---Setting range---

- 0 to 100
- 0: Default value

【#9737】 Host 2 Wrd pos: size

Set the size display position (nth word from left) of the list displayed when the ftp command "dir" is executed.

(Note) One word designates a character string divided by one or more spaces.

---Setting range---

- 0 to 100
- 0: Default value

【#9738】 Host 2 Wrd pos: Dir

Set the <DIR> display position (nth word from left) of the list displayed when the ftp command "dir" is executed.

(Note) One word designates a character string divided by one or more spaces.

---Setting range---

- 0 to 100
- 0: Default value

【#9739】 Host 2 Wrd pos: cmnt

Set the comment (date, time, etc.) display position (nth word from left) of the list displayed when the ftp command "dir" is executed.

(Note) One word designates a character string divided by one or more spaces.

---Setting range---

- 0 to 100
- 0: Default value

【#9740】 Host 2 Wrd num: cmnt

Set the number of words to be displayed as a comment.

(Note) One word designates a character string divided by one or more spaces.

---Setting range---

- 0 to 100
- 0: Default value

【#9741】 Host 2 no total siz

Set whether to display the total number of characters registered in the machining programs of host1 when displaying the file list.

If there are many files in the directory to be referred to, the list can be updated quickly by setting "1".

- 0: Display
- 1: Not display

【#9751】 Host3 host name

Set the host computer name.

This parameter allows the NC to easily recognize the host computer on the network. Set the host computer's name (name registered in C:\windows\hosts) or the IP address.

<Setting example>

For host name: mspc160

For IP address: 150.40.0.111

(Note) Set the host computer's TCP/IP address if communication is not carried out correctly.

---Setting range---

15 characters (alphanumeric) or less

【#9752】 Host3 user name

Set the user name when logging into the host computer.

---Setting range---

15 characters (alphanumeric) or less

【#9753】 Host3 password

Set the password when logging into the host computer.

---Setting range---

15 characters (alphanumeric) or less

【#9754】 Host3 directory

Set the directory name of the host computer.

The directory released to the client (NC unit) with the host computer's server is handled as the root directory by the NC unit.

---Setting range---

31 characters (alphanumeric) or less

【#9755】 Host3 host type

Select the type of the host computer.

- 0: UNIX/PC automatic judgment
- 1: UNIX
- 2: PC (DOS)

(Note) When "0" is set, the settings for the following parameters will be invalid.

- #9756 Wrd pos: name
- #9757 Wrd pos: size
- #9758 Wrd pos: Dir
- #9759 Wrd pos: cmnt
- #9760 Wrd num: cmnt

【#9756】 Host 3 Wrd pos: name

Set the file name display position (nth word from left) of the list displayed when the ftp command "dir" is executed.

(Note) One word designates a character string divided by one or more spaces.

---Setting range---

- 0 to 100
- 0: Default value

【#9757】 Host 3 Wrd pos: size

Set the size display position (nth word from left) of the list displayed when the ftp command "dir" is executed.

(Note) One word designates a character string divided by one or more spaces.

---Setting range---
 0 to 100
 0: Default value

【#9758】 Host 3 Wrd pos: Dir

Set the <DIR> display position (nth word from left) of the list displayed when the ftp command "dir" is executed.

(Note) One word designates a character string divided by one or more spaces.

---Setting range---
 0 to 100
 0: Default value

【#9759】 Host 3 Wrd pos: cmnt

Set the comment (date, time, etc.) display position (nth word from left) of the list displayed when the ftp command "dir" is executed.

(Note) One word designates a character string divided by one or more spaces.

---Setting range---
 0 to 100
 0: Default value

【#9760】 Host 3 Wrd num: cmnt

Set the number of words to be displayed as a comment.

(Note) One word designates a character string divided by one or more spaces.

---Setting range---
 0 to 100
 0: Default value

【#9761】 Host 3 no total siz

Set whether to display the total number of characters registered in the machining programs of host1 when displaying the file list.

If there are many files in the directory to be referred to, the list can be updated quickly by setting "1".

0: Display
 1: Not display

【#9771】 Host4 host name

Set the host computer name.

This parameter allows the NC to easily recognize the host computer on the network. Set the host computer's name (name registered in C:\windows\hosts) or the IP address.

<Setting example>

For host name: mspc160
 For IP address: 150.40.0.111

(Note) Set the host computer's TCP/IP address if communication is not carried out correctly.

---Setting range---
 15 characters (alphanumeric) or less

【#9772】 Host4 user name

Set the user name when logging into the host computer.

---Setting range---
 15 characters (alphanumeric) or less

【#9773】 Host4 password

Set the password when logging into the host computer.

---Setting range---

15 characters (alphanumeric) or less

【#9774】 Host4 directory

Set the directory name of the host computer.

The directory released to the client (NC unit) with the host computer's server is handled as the root directory by the NC unit.

---Setting range---

31 characters (alphanumeric) or less

【#9775】 Host4 host type

Select the type of the host computer.

0: UNIX/PC automatic judgment

1: UNIX

2: PC (DOS)

(Note) When "0" is set, the settings for the following parameters will be invalid.

- #9776 Wrd pos: name

- #9777 Wrd pos: size

- #9778 Wrd pos: Dir

- #9779 Wrd pos: cmnt

- #9780 Wrd num: cmnt

【#9776】 Host 4 Wrd pos: name

Set the file name display position (nth word from left) of the list displayed when the ftp command "dir" is executed.

(Note) One word designates a character string divided by one or more spaces.

---Setting range---

0 to 100

0: Default value

【#9777】 Host 4 Wrd pos: size

Set the size display position (nth word from left) of the list displayed when the ftp command "dir" is executed.

(Note) One word designates a character string divided by one or more spaces.

---Setting range---

0 to 100

0: Default value

【#9778】 Host 4 Wrd pos: Dir

Set the <DIR> display position (nth word from left) of the list displayed when the ftp command "dir" is executed.

(Note) One word designates a character string divided by one or more spaces.

---Setting range---

0 to 100

0: Default value

【#9779】 Host 4 Wrd pos: cmnt

Set the comment (date, time, etc.) display position (nth word from left) of the list displayed when the ftp command "dir" is executed.

(Note) One word designates a character string divided by one or more spaces.

---Setting range---

0 to 100

0: Default value

【#9780】 Host 4 Wrd num: cmnt

Set the number of words to be displayed as a comment.

(Note) One word designates a character string divided by one or more spaces.

---Setting range---

0 to 100

0: Default value

【#9781】 Host 4 no total siz

Set whether to display the total number of characters registered in the machining programs of host1 when displaying the file list.

If there are many files in the directory to be referred to, the list can be updated quickly by setting "1".

0: Display

1: Not display

2.3 Base Specifications Parameters

The parameters with "(PR)" requires the CNC to be turned OFF after the settings. Turn the power OFF and ON to enable the parameter settings.

【#1000】 ParaForm Parameter changeover input/output format

Select the maximum part system configuration for parameter input/output.

0: Parameter for the maximum system configuration of two part systems and PLC axis is input/output.

1: Parameter for the maximum system configuration of four part systems and PLC axis can be input/output.

(Note 1) Set to 1 for three or more part systems.

(Note 2) This parameter is enabled only for parameter I/O type II(#1218 aux02/bit3 is set to "1").

【#1001(PR)】 SYS_ON System validation setup

Select the existence of PLC axes and part systems.

0: Not exist

1: Exist

【#1002(PR)】 axisno Number of axes

Set the number of control axes and PLC axes.

A total of 16 axes can be set.

Control axis: 0 to 16

PLC axis: 0 to 4

When set to "0", the number of control axes in the part system will be "0". Do not set the number of control axes of the first part system to "0".

(Note) The setting range differs according to the model.

【#1003(PR)】 iunit Input setup unit

Select the input setting value for each part system and the PLC axis.

Increments in parameters will follow this selection.

B : 1 μ m

C : 0.1 μ m

D : 0.01 μ m (10nm)

E : 0.001 μ m (1nm)

【#1004(PR)】 clunit Control unit

Select the control increment for each part system and PLC axis.

Select the increment for the NC internal position data, communication data between the NC and drive unit, and the servo travel data. Increments for the pitch error and backlash, will follow the setting unit of #1003 iunit.

E: 0.001 μ m (1nm)

【#1005(PR)】 plcunit PLC unit

Select the PLC interface setting and display increment.

The PLC interface setting and display increment will follow this specification. Note that the PLC axis will follow "#1003 iunit".

B: 1 μ m

C: 0.1 μ m

D: 0.01 μ m(10nm)

E: 0.001 μ m(1nm)

【#1010(PR)】 srvunit Output unit (servo)

Select the output increment to servo.

B: 1 μ m

C: 0.1 μ m

D: 0.01 μ m

E: 0.001 μ m

【#1013(PR)】 axname Axis name

Set each axis' name with an alphabetic character.
Use the characters X, Y, Z, U, V, W, A, B or C.

(Note 1) Do not set the same name twice in one part system.

The same name which is used in another part system can be set.

(Note 2) The PLC name does not need to be set. (Numbers 1 and 2 are shown as the axis names.)

---Setting range---

X,Y,Z,U,V,W,A,B,C

【#1014(PR)】 incax Increment command axis name

Set the axis name when commanding an incremental value for the axis travel amount.
Available alphabets are the same as in "#1013 axname".

(Note 1) Set an alphabet that is different from that of "#1013 axname".

(Note 2) Setting is not required if absolute/incremental specification with axis names is not performed ("#1076 AbsInc" = "0").

---Setting range---

X, Y, Z, U, V, W, A, B, C

【#1015(PR)】 cunit Program command unit

Set the minimum increment of program travel command.

cunit Travel amount for travel command 1

0: Follow "#1003 iunit"

1: 0.0001 mm (0.1 μm)

10: 0.001 mm (1 μm)

100: 0.01 mm (10 μm)

1000: 0.1 mm (100 μm)

10000: 1.0 mm

If there is a decimal point in travel command, the decimal point position will be handled as 1mm regardless of this setting.

【#1016(PR)】 iout

Not used. Set to "0".

【#1017(PR)】 rot Rotational axis

Select whether the axis is a rotary axis or a linear axis. The axis, if designated as rotary, returns to "0°" position when the position displays "360°". To display the position continuously, apply the linear axis designation even for the rotary axis.

0: Linear axis

1: Rotary axis

【#1018(PR)】 ccw Motor CCW

Select the direction of the motor rotation to the command direction.

0: Clockwise (looking from motor shaft) with the forward rotation command

1: Counterclockwise (looking from motor shaft) with the forward rotation command

【#1019(PR)】 dia Diameter specification axis

Select the command method of program travel amount.

When the travel amount is commanded with the diameter dimensions, the travel distance will be 5mm when the command is 10mm of travel distance.

The travel amount per pulse will also be halved during manual pulse feed.

If diameter is selected, tool length, the wear compensation amount, and the workpiece coordinate offset will be displayed in diameter value. Other parameters concerning length will always be displayed in radius value.

0: Command with travel amount

1: Command with diameter dimension

【#1020(PR)】 sp_ax Spindle Interpolation

Select "1" when using the spindle for the contour control of NC axis (C-axis).

0: Servo axis is used for contour control.

1: Spindle is used for contour control.

【#1021(PR)】 mcp_no Drive unit I/F channel No. (servo)

Using a 4-digit number, set the drive unit interface channel No. and which axis in that channel is to be used when connecting a servo drive unit.

High-order two digits: Drive unit interface channel No.

Low-order two digits: Axis No.

【#1022(PR)】 axname2 2nd axis name

Set the name of the axis displayed on the screen with two characters. (X1, Z2, etc.)

Always use an alphabetic character (A to Z) for the first character.

---Setting range---

A to Z and 1 to 9 (Two digits)

(Setting will be cleared when "0" is set)

【#1023(PR)】 crsadr

Not used. Set to "0".

【#1024】 crsinc

Not used. Set to "0".

【#1025】 l_plane Initial plane selection

Select the plane to be selected when the power is turned ON or reset.

0: X-Y plane (G17 command state)

1: X-Y plane (G17 command state)

2: Z-X plane (G18 command state)

3: Y-Z plane (G19 command state)

【#1026】 base_I Base axis I

Set the names of the basic axes that compose the plane.

Set the axis name set in "#1013 axname".

If all three items ("base_I", "base_J" and "base_K") do not need to be set, such as for 2-axis specifications, input "0", and the parameter will be blank.

Normally, when X, Y and Z are specified respectively for base_I, _J, _K, the following relation will be established:

G17: X-Y

G18: Z-X

G19: Y-Z

Specify the desired axis name to set an axis address other than above.

---Setting range---

Axis names such as X, Y or Z

【#1027】 base_J Base axis J

Set the names of the basic axes that compose the plane.

Set the axis name set in "#1013 axname".

If all three items ("base_I", "base_J" and "base_K") do not need to be set, such as for 2-axis specifications, input "0", and the parameter will be blank.

Normally, when X, Y and Z are specified respectively for base_I, _J, _K, the following relation will be established:

G17: X-Y

G18: Z-X

G19: Y-Z

Specify the desired axis name to set an axis address other than above.

---Setting range---

Axis names such as X, Y or Z

【#1028】 base_K Base axis K

Set the names of the basic axes that compose the plane.
 Set the axis name set in "#1013 axname".
 If all three items ("base_I", "base_J" and "base_K") do not need to be set, such as for 2-axis specifications, input "0", and the parameter will be blank.
 Normally, when X, Y and Z are specified respectively for base_I, _J, _K, the following relation will be established:
 G17: X-Y
 G18: Z-X
 G19: Y-Z
 Specify the desired axis name to set an axis address other than above.

---Setting range---

Axis names such as X, Y or Z

【#1029】 aux_I Flat axis I

Set the axis name when there is an axis parallel to "#1026 base_I".

---Setting range---

Axis names such as X, Y or Z

【#1030】 aux_J Flat axis J

Set the axis name when there is an axis parallel to "#1027 base_J".

---Setting range---

Axis names such as X, Y or Z

【#1031】 aux_K Flat axis K

Set the axis name when there is an axis parallel to "#1028 base_K".

---Setting range---

Axis names such as X, Y or Z

【#1037(PR)】 cmdtyp Command type

Set the G code list and compensation type for programs.
 1 : List 1 (for M): Type I (one compensation amount for one compensation No.)
 2 : List 1 (for M): Type II (shape and wear compensation amounts for one comp. No.)
 3 : List 2 (for L): Type III (shape and wear compensation amounts for one comp. No.)
 4 : List 3 (for L): Ditto
 5 : List 4 (for special L): Ditto
 6 : List 5 (for special L): Ditto
 7 : List 6 (for special L): Ditto
 8 : List 7 (for special L): Ditto

There are some items in the specifications that can be used or cannot be used according to the value set in this parameter.
 The file structure may also change depending on the compensation data type.

(Note) When this parameter is changed, the file system will be changed after the power is turned ON.
 So always execute format.
 The new format will be enabled after turning the power ON again.

Setting order

(1) cmdtyp changeover -> (2) Turn power ON again -> (3) Format -> (4) Turn power ON again

【#1038】 plcsel Ladder selection

Not used. Set to "0".

【#1039(PR)】 spinno Number of spindles

Select the number of spindles.
 0: No spindle
 1 to 4: One to four spindles

(Note) The setting range differs according to the model.

【#1040(PR)】 M_inch Constant input (inch)

Select the unit system for setting and display regarding machine parameter and PLC interface's position, length and speed.

0: Metric system

【#1041(PR)】 I_inch Initial state (inch)

Select the unit system for the program travel amount when the power is turned ON or reset and for position display.

0: Metric system

【#1042(PR)】 pcinch PLC axis command (inch)

Select the unit system for the commands to the PLC axis.

0: Metric system

【#1043】 lang Select language displayed

Select the display language.

- 0: Japanese (Standard)
- 1: English (Standard)
- 11: German (Option)
- 12: French (Option)
- 13: Italian (Option)
- 14: Spanish (Option)
- 15: Traditional Chinese (Option)
- 16: Korean (Option)
- 17: Portuguese (Option)
- 18: Dutch (Option)
- 19: Swedish (Option)
- 20: Hungarian (Option)
- 21: Polish (Option)
- 22: Simplified Chinese (Option)
- 23: Russian (Option)
- 24: Turkish (Option)
- 25: Czech (Option)

(Note) A language which can be displayed is different according to each series.

【#1044(PR)】 auxno

Not used. Set to "0".

【#1045(PR)】 nskno

Not used. Set to "0".

【#1049 (PR)】 mmac_R MTB macro RAM-ROM change

Select for the machine tool builder macro program storage area.

- 0: SRAM area
- 1: FROM area

(Note) Setting "1" is allowed only when the machine tool builder macro option is enabled.

【#1050(PR)】 MemPrg Definition of program save area

Select part system common or independent for the usage of the save area for machining programs.

- 0 or 2: Part system common
 - 1 or 3: Part system independent
- For MDI data, select the system independent regardless of parameters.

【#1051(PR)】 MemTol Tool compensation memory common for part systems

- 0: Tool compensation memory separate for part systems
- 1: Tool compensation memory common for part systems

【#1052(PR) MemVal No. of common variables shared in part system designation

0: Common variables common for part systems (number fixed)
#100 - : Per part system
#500 - : Common for part systems
1: Common variables common for part systems (number designation)
#100 - : Designate with V1comN
#500 - : Designate with V0comN

(Note) When this parameter is changed, the file system will be changed after the power is turned ON.

So always execute format.

The new format will be enabled after turning the power ON again.

Setting order

(1) MemVal changeover -> (2) Turn power ON again -> (3) Format -> (4) Turn power ON again

【#1058(PR) NcScrn NC screen type

Select the NC screen type.

0: MELDAS screen

1: Mitsubishi HMI screen

#1060] SETUP Activate setup processing

Execute the functions required for initializing the system.

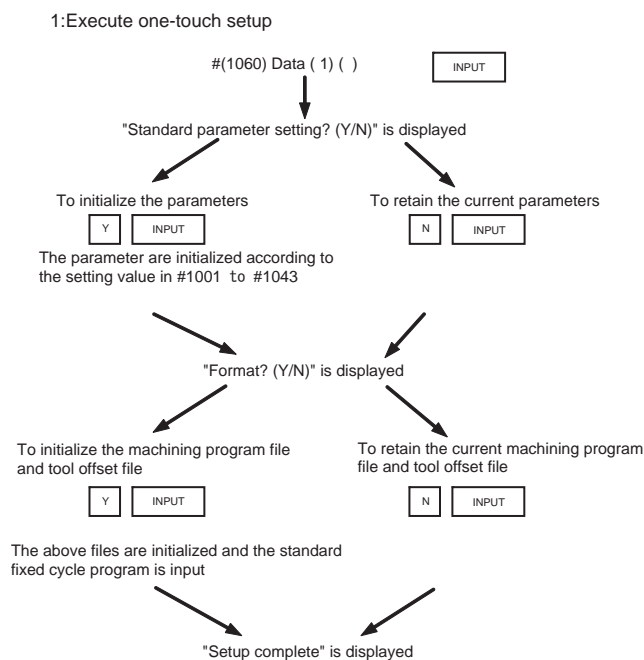

(Note) Most setup parameters will be initialized with one-touch setup. so confirm the data before executing. This parameter will automatically be set to "0" when the power is turned ON.

2: Execute data erasing.
The erasing is executed for "tool offset", "tool life" and then "variable".

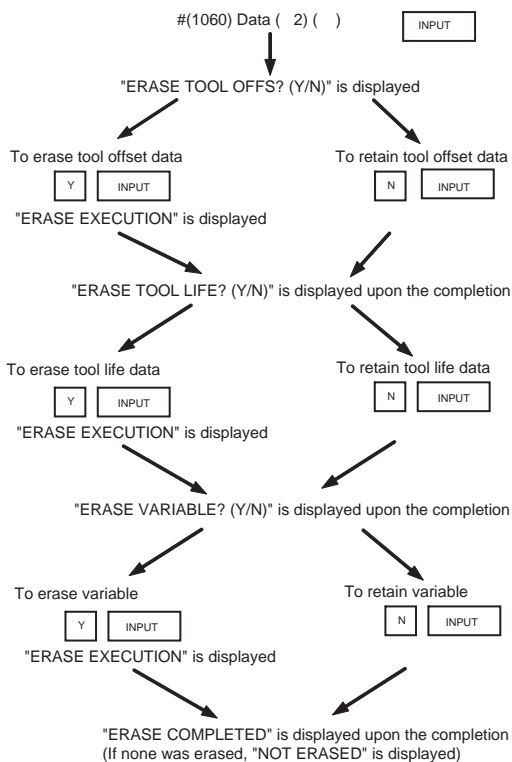

【#1061(PR) intabs Manual ABS updating

Select whether to update the absolute position data during automatic handle interrupt.
 This parameter is enabled only when "#1145 I_abs" is set to "1".
 0: Do not update (coordinate system shifted the amount of the interruption)
 1: Update (same coordinates as when interrupt did not occur will be applied)

【#1062] T_cmp Tool compensation function

Select whether the tool length compensation and wear compensation are enabled during T command execution.

0 : Tool length compensation enable	Wear compensation enable
1 : Tool length compensation enable	Wear compensation disable
2 : Tool length compensation disable	Wear compensation enable
3 : Tool length compensation disable	Wear compensation disable

【#1063] mandog Manual dog-type

Select the manual reference position return method for the second return (after the coordinate system is established) and later.
 The initial reference position return after the power ON is performed with dog-type return, and the coordinate system will be established.
 (This setting is not required when the absolute position detection is used.)
 0: High speed return
 1: Dog-type

【#1064(PR) svof Error correction

Select whether to correct the error when the servo is OFF.
 0: Not correct the error
 1: Correct the error

【#1065] JOG_H JOG response type

Set the JOG responsiveness type.

- 0: Conventional specification
 JOG is started or stopped by a signal via ladder without reference to an external signal input.
- 1: Type 1
 JOG is started or stopped by an external signal.
- 2: Type 2
 JOG is started or stopped by logical AND of an external signal and a signal via ladder.
- 3: Type 3
 JOG is started when a signal via ladder rises. It is stopped when an external signal and a signal via ladder fall.
- 4: Type 4
 Reference position return mode:
 JOG is started or stopped by a signal via ladder without reference to an external input signal (conventional specification).
 Non-reference position return mode:
 JOG is started or stopped by logical AND of an external signal and a signal via ladder (type 2).

---Setting range---
 0 to 4

【#1066] JOG_HP Select JOG activation (+) device

Set the device No. to input +JOG activation signal.
 The device type is specified by "#1071 JOG_D".
 The effective setting range varies depending on the device type.
 A value specified outside of the effective range is invalid.

---Setting range---
 X: 0000 to 013F (hexadecimal)
 G: 0000 to 3071
 M: 0000 to 5119 (decimal)

【#1067】 JOG_HN Select JOG activation (-) device

Set the device No. to input -JOG activation signal.
 The device type is specified by "#1071 JOG_D".
 The effective setting range varies depending on the device type.
 A value specified outside of the effective range is invalid.

---Setting range---

X: 0000 to 013F (hexadecimal)
 G: 0000 to 3071
 M: 0000 to 5119 (decimal)

【#1068(PR)】 slavno Secondary axis number

Set the axis number of the secondary axis in synchronous control.
 The axis number is an NC number excluding the spindle and PLC axis.
 Two or more secondary axes cannot be set for one primary axis.
 This parameter cannot be set for a secondary axis.
 When using the multi-part system, the relation of the primary axis and secondary axis cannot extend over part systems.
 0: No secondary axis
 1 to 6: First to sixth axis

【#1069】 no_dsp Axis with no counter display

Select whether to display the axis counter or not.
 This setting is enabled on the counter display screen (relative position counter, etc.).
 0: Display
 1: Not display

【#1070】 axoff Axis removal

Select whether to enable or disable axis removal control.
 0: Disable
 1: Enable

【#1071(PR)】 JOG_D JOG activation signal device name

Select the device No. to input JOG activation signal(+/-).
 0 : X device
 1 : G device
 2 : M device
 Set the parameters "#1066 JOG_HP" and "#1067 JOG_HN" according to this device specification parameter.

【#1072】 chop_ax

Not used. Set to "0".

【#1073】 I_Absm Initial absolute setting

Select the mode (absolute or incremental) at turning ON the power or reset.
 0: Incremental setting
 1: Absolute setting

【#1074】 I_Sync Initial synchronous feed

Select the feedrate mode at turning ON the power or reset.
 0: Asynchronous feed (feed per minute)
 1: Synchronous feed (feed per revolution)

【#1075】 I_G00 Initial G00

Select the linear command mode at turning ON the power or reset.
 0: Linear interpolation (G01 command state)
 1: Positioning (G00 command state)

【#1076】 AbsInc ABS/INC address (for L system only)

Select the command method for the absolute and incremental commands.

- 0: Use G command for the absolute and incremental commands.
- 1: Use axis name for the absolute and incremental commands.

(The axis name in "#1013 axname" will be the absolute command, "#1014 incax" will be the incremental command.)

When "1" is selected, using two axis names, one each for the absolute and incremental commands, allows to issue the absolute and incremental commands appropriately to an axis.

【#1077】 radius Incremental command for diameter specification axis

Select whether the incremental command of the diameter specification axis ("#1019 dia" is set to "1") uses the diameter value or radius value.

- 0: Diameter value
- 1: Radius value

【#1078】 Decpt2 Decimal point type 2

Select the increment of position commands that do not have a decimal point.

- 0: Minimum input command unit (follows "#1015 cunit")
- 1: 1mm (or 1inch) unit (For the dwell time, 1s unit is used.)

【#1079】 F1dgt Validate F1 digit

Select the F command method.

- 0: Direct numerical command (command feedrate during feed per minute or rotation)
- 1: 1-digit code command (feedrate set with "#1185 spd_F1" to "#1189 spd_F5")

【#1080】 Dril_Z Specify boring axis (for M system only)

Select a fixed cycle hole drilling axis.

- 0: Use an axis vertical to the selected plane as hole drilling axis.
- 1: Use the Z axis as the hole drilling axis regardless of the selected plane.

【#1081】 Gmac_P Give priority to G code parameter

Select the G code priority relationship during the macro call with G command.

- 0: Priority is on G code used in the system
- 1: Priority is on registered G code for call

【#1082】 Geomet Geometric

Select the type of geometric to use.

- 0: Not use
- 1: Use only geometric I
- 2: Use geometric I and IB

With geometric, specific address codes are used for exclusive meanings. Thus, if A or C is used for the axis name or 2nd miscellaneous command code, the A used for the axis name may function as the geometric's angle designation. Pay special attention to axis names, etc., when using this function.

【#1084】 RadErr Arc error

Set the tolerable error range when the end point deviates from the center coordinate in the circular command.

---Setting range---
0 to 1.000 (mm)

【#1085】 G00Drn G00 dry run

Select whether to apply dry run (feed at manual setting speed instead of command feedrate) to the G00 command.

- 0: Not apply to G00. (move at rapid traverse rate)
- 1: Apply to G00. (move at manual setting speed)

【#1086】 G0Intp G00 non-interpolation

Select the G00 travel path type.

- 0: Move linearly toward the end point. (interpolation type)
- 1: Move to the end point of each axis at the rapid traverse feedrate for each axis. (non-interpolation)

(Note) If this parameter is set to "1", neither of the following functions will be available: rapid traverse constant inclination acceleration/deceleration and rapid traverse constant inclination multi-step acceleration/deceleration.

【#1087】 G96_G0 Constant surface speed control by rapid traverse feed command

Select how to handle the surface speed for the G00 command when using the constant surface speed control function.

- 0: Calculate the surface speed constantly even during G00 movement
- 1: Calculate the surface speed at the block end point in the G00 command

【#1088】 G30SL Disable G30 soft limit

Select how to handle the soft limit during G30 (2nd reference position return).

- 0: Enable
- 1: Disable

【#1089】 Cut_RT Short cut for rotary axis

Select whether to use the short-cut control for the rotary axis (with "1" in "#1017 rot").

- 0: Not use the short cut. The axis moves toward the end point.
- 1: Use the short cut. When the absolute value command is used, the axis moves in the direction where the movement amount will be "180°" or less.

This parameter is applicable to M730BM version A.
From M730BM version B and above, this is set in #8213.

【#1090】 Lin_RT Linear rotary axis

Select how to command the rotary axis with the absolute value command exceeding "360°".

- 0: Convert the value into a remainder of "360°" before moving the axis. (Ex: The command of "420°" is converted into the movement of "60°".)
- 1: Move the axis in the same manner as a linear axis. (Ex: The command of "420°" moves the axis to the "60°" position through the "360°" position.)

This parameter is applicable to M730BM version A.
From M730BM version B and above, this is set in #8213.

【#1091】 Mpoint Ignore middle point

Select how to handle the middle point during G28 and G30 reference position return.

- 0: Pass the middle point designated in the program and move to the reference position.
- 1: Ignore the middle point designated in the program and move straight to the reference position.

【#1092】 Tchg_A Replace tools for additional axis

Select the movement of the additional axis at the tool change position return command.

- 0: The additional axis will not move
- 1: After the standard axis returns, the additional axis will also return to the tool change position

【#1093】 Wmvfin Synchronization between part systems method

Select the timing of synchronization between part systems when using the multi-part system.
When the travel command is found in the synchronization command (!, M) block:

- 0: Synchronize before executing travel command
- 1: Synchronize after executing travel command

【#1094】 TI_SBK Select life count for single block (for L system only)

Select whether to count the data units to be used for single block operation when using the tool life management II function (L system).

- 0: Not count
- 1: Count

【#1095】 T0tfof TF output (for L system only)

Select how to handle TF for T00 command.
 0: TF will be output
 1: TF wont be output

【#1096(PR)】 T_Ltyp Tool life management type

Select the tool life management type.

1: Life management I
 In this type, how long and how many times the program commanded tool is used are accumulated to monitor the usage state.

2: Life management II
 This method is the same as tool life management I, but with the spare tool selection function. A spare tool is selected from a group of tool commands commanded in the program. Tool compensation (tool length compensation and tool radius compensation) is carried out for the selected tool.

3: Life management III (for M system only)
 The usage time, frequency of use or the wear amount of the tool which is designated by the program is accumulated, and the tool usage state is monitored. It is not managed by the group number.
 (Note) When "3" is set for the L system, the Life management I is selected.

【#1097】 T1digt Tool wear compensation number 1-digit command

Select the number of digits of the tool wear compensation No. in the T command.
 0: The 2 high-order digits are the tool No., and the 2 low-order digits are the wear compensation No.
 1: The 3 high-order digits are the tool No., and the 1 low-order digit is the wear compensation No.

This parameter will be fixed to "0" when tool life management II is selected.

【#1098】 TLno. Tool length offset number

Select the number of digits of the tool length compensation No. in the T command.
 0: The 2 or 3 high-order digits are the tool No.
 The 2 or 1 low-order digits are the tool length compensation and wear compensation Nos.
 1: The 2 or 3 high-order digits are the tool No. and tool length compensation Nos.
 The 2 or 1 low-order digits are the wear compensation No.

【#1099】 Treset Cancel tool compensation amount

Select how to handle the tool compensation vector when resetting the system.
 0: Clear the tool length and wear compensation vectors when resetting
 1: Hold the tool length and wear compensation vectors when resetting

When the values are cleared, the compensation will not be applied. So the axis will be shifted by the compensation amount in the next compensation operation.
 When the values are kept, the compensation will be applied, so the axis will shift the differential amount of the compensation amount in the next compensation operation.

【#1100】 Tmove Tool compensation

Select when to perform tool length compensation and wear compensation.
 0: Compensate when T command is executed.
 1: Superimpose and compensate with the travel command in the block where the T command is located. If there is no travel command in the same block, compensation will be executed after the travel command is superimposed in the next travel command block.
 2: Compensate the wear amount when the T command is executed. Superimpose and compensate the tool length compensation amount with the travel command in the same block. If there is no travel command in the same block, compensation will be executed after the travel command is superimposed in the next travel command block.

【#1101】 Tabsmv Tool compensation method

Select the type of travel command when "#1100 Tmove" is set to "1" or "2".
 0: Compensate regardless of the travel command type
 1: Compensate only at the travel command in the absolute command

【#1102】 tlm Manual tool length measuring system (for L system only)

Select the measurement method for manual tool measurement I.

- 0: Align tool with basic point
- 1: Input measurement results

(Note) Interpreted as "0" when other than "0" or "1" is set.

【#1103】 T_life Validate life management

Select whether to use the tool life management.

- 0: Not use
- 1: Use

【#1104】 T_Com2 Tool command method 2

Select how to handle the tool command in the program when "#1103 T_life" is set to "1".

- 0: Handle the command as group No.
- 1: Handle the command as tool No.

【#1105】 T_Sel2 Tool selection method 2

Select the tool selection method when "#1103 T_life" is set to "1".

- 0: Select in order of registered No. from the tools used in the same group.
- 1: Select the tool with the longest remaining life from the tools used or unused in the same group.

【#1106】 Tcount Life management (for L system only)

Select the input method when address N is omitted in inputting the data (G10 L3 command) for tool life management function II.

- 0: Time specified input
- 1: Number of times specified input

【#1107】 TlIfsc Split life management display screen (for L system only)

Set the number of groups to be displayed on the tool life management II (L system) screen.

- 0: Displayed group count 1, maximum number of registered tools: 16
- 1: Displayed group count 2, maximum number of registered tools: 8
- 2: Displayed group count 4, maximum number of registered tools: 4

【#1108】 TirectM Life management re-count M code (for L system only)

Set the M code for tool life management II (L system) re-count.

---Setting range---

0 to 99

【#1109】 subs_M Validate alternate M code

Select the user macro interrupt with the substitute M code.

- 0: Disable alternate M code
- 1: Enable alternate M code

【#1110】 M96_M M96 alternate M code

Set an M code to replace M96 when "#1109 subs_M" is set to "1".

---Setting range---

3 to 97 (excluding 30)

【#1111】 M97_M M97 alternate M code

Specify an M code to replace M97 when #1109 subs_M is set to 1.

---Setting range---

3 to 97 (excluding 30)

【#1112(PR)】 S_TRG Validate status trigger method

Select the enable conditions for the user macro interrupt signal (UIT).

- 0: Enable when interrupt signal (UIT) turns ON
- 1: Enable when interrupt signal (UIT) is ON

【#1113(PR)】 INT_2 Validate interrupt method type 2

Select the performance after user macro interrupt signal (UIT) input.

- 0: Execute interrupt program without waiting for block being executed to end
- 1: Execute interrupt program after completing block being executed

【#1114】 mcrint Macro argument initialization

Select whether to clear statements other than specified arguments by macro call.
Also select whether to clear local variables by power-ON and resetting.

- 0: Clear the non-specified arguments by macro call.
- 1: Hold non-specified arguments by macro call
- 2: Hold non-specified arguments by macro call, and clear local variables by power-ON and resetting

【#1115】 thwait Waiting for thread cutting

Set the queue number during screw thread cutting when chamfering is disabled.

---Setting range---

- 0 to 99 (Approx. 4 ms)
- Standard setting value: 4

【#1116】 G30SLM Invalidate soft limit (manual operation)

Enable this function when disabling the soft limit check function at the second to fourth reference position return.

- 0: Enable soft limit function
- 1: Disable soft limit function

【#1117(PR)】 H_sens

Select the handle response mode during handle feed.

- 0: Standard
- 1: High-speed

【#1118】 mirr_A Select how to set up the length of tools on cutter tables (opposed tables) (for L system only)

Select one of the following two methods:

- Set the current length of tools on each facing turret.
- Set a value, assuming that the tools on each facing turret are in the same direction as that of those on the base turret.

- 0: Current length of the tools on each facing turret
- 1: Value, assuming that the tools on each facing turret are in the same direction as that of those on the base turret

【#1119】 Tmiron Select the mirror image of each facing turret with T command (for L system only)

Select whether to enable the mirror image of each facing turret with the T command.

- 0: Disable
- 1: Enable

【#1120(PR)】 TofVal Change macro variable

Select whether to change the macro variable (tool offset) numbers for shape compensation and wear compensation.

- 0: Not change (Conventional specification)
- 1: Change the shape and wear compensation variable numbers each for X, Z, and R

【#1121】 edlk_c Edit lock C

Select the edit lock for program Nos. 9000 to 9999 in memory.

- 0: Editing possible
- 1: Editing prohibited. The file cannot be opened.

(Note) If "#1122" is set to "1" or "2", "1" will be set in "#1121" when the power is turned ON.

【#1122(PR)】 pglk_c Program display lock C

Select whether to prohibit the program display and search for program Nos. 9000 to 9999 in memory.

- 0: Program display and search is possible
- 1: Program display is impossible. Search is possible.
- 2: Program display and search is impossible

(Note) If “#1122” is set to “1” or “2”, “1” will be set in “#1121” when the power is turned ON.

【#1123】 origin Origin set prohibit

Select whether to use the origin set function.

- 0: Use
- 1: Not use

【#1124】 ofsfix Fix tool compensation No.

Select how to handle the compensation No. when the input key is pressed on the tool compensation screen.

- 0: Increment the compensation No. by 1 (Same as general parameters)
- 1: # compensation No. does not change

When setting in sequence, “0” is handier. When changing and setting repeatedly while adjusting one compensation value, “1” is handier

【#1125】 real_f Actual feedrate display

Select the feedrate display on the monitor screen.

- 0: Command speed
- 1: Actual travel feedrate

【#1126】 PB_G90 Playback G90

Select the method to command the playback travel amount in the playback editing.

- 0: Incremental value
- 1: Absolute value

【#1127】 DPRINT DPRINT alignment

Select the alignment for printing out with the DPRINT function.

- 0: No alignment, output s printed with left justification
- 1: Align the minimum digit and output

【#1128】 RstVCI Clear variables by resetting

Select how to handle the common variables when resetting.

- 0: Common variables won't change after resetting.
- 1: The following common variables will be cleared by resetting:
 - #100 to #149 when 100 sets of variables are provided.
 - #100 to #199 when 200 sets or more of variables are provided.

【#1129】 PwrVCI Clear variables by power-ON

Select how to handle the common variables when the power is turned ON.

- 0: The common variables are in the same state as before turning the power OFF.
- 1: The following common variables will be cleared when the power is turned ON:
 - #100 to #149 when 100 sets of variables are provided.
 - #100 to #199 when 200 sets or more of variables are provided.

【#1130】 set_t Display selected tool number

Select the tool command value display on the POSITION screen.

- 0: Display T-modal value of program command
- 1: Display Tool No. sent from PLC

【#1132】 CRT

Not used. Set to "0".

【#1133】 ofsmem Select how to set up tool wear compensation screen

Select whether to display the # number stored at the previous setup, when selecting the tool compensation screen.

- 0: Not display the # number when selecting the screen.
- 1: Display the stored # number when selecting the screen.

【#1134】 LCDneg

Not used. Set to "0".

【#1135】 unt_nm Unit name

Set the unit name.
Set with 4 or less characters consisting of both alphabets and numbers.
If "0" is set, the unit name won't be displayed.

---Setting range---

4 or less characters consisting of both alphabets and numbers

【#1136】 optype

Not used. Set to "0".

【#1137】 Cntsel

Not used. Set to "0".

【#1138】 Pnose1 Select screen by parameter number

Select whether to enable the function to select a screen by specifying a parameter number.

- 0: Disable
- 1: Enable

【#1139】 edtype Edit type selection

Select an edit type.

- 0: Screen edit type
- 1: Screen edit type (The screen of EDIT or MDI is changed automatically according to the selected operation mode.)
- 2: Word edit type (The screen of EDIT or MDI is changed automatically according to the selected operation mode.)
- 3: Screen edit type (type 0 + retaining cursor position)
- 4: Screen edit type (type 1 + retaining cursor position)

【#1140】 Mn100 M code number

Set the first number of M code that corresponds to the setup Nos. from 100 to 199.

---Setting range-

0 to 99999999

【#1141】 Mn200 M code number

Set the first number of M code that corresponds to the setup Nos. from 200 to 299.

---Setting range---

0 to 99999999

【#1142】 Mn300 M code number

Set the first number of M code that corresponds to the setup Nos. from 300 to 399.

---Setting range---

0 to 99999999

【#1143】 Mn400 M code number

Set the first number of M code that corresponds to the setup Nos. from 400 to 499.

---Setting range---

0 to 99999999

【#1144】 mdlkof MDI setup lock

Select whether to enable MDI setting in non-MDI mode.
 0: Disable MDI setting
 1: Enable MDI setting

【#1145】 l_abs Manual ABS parameter

Select how to handle the absolute position data during automatic handle interrupt.
 0: Absolute position data will be renewed if manual ABS switch is ON. If it is OFF, data won't be renewed.
 1: Follow the "intabs" state when "#1061 intabs" is enabled

【#1146】 Sclamp Spindle rotation speed clamp function

Select how to handle the spindle rotation speed clamp function with the G92S command.
 0: G92S command is handled as a clamp command only in the G96 state (during constant surface speed control).
 G92S will be handled as normal S command in G97 state (constant surface speed OFF).
 1: The S command in the same block as G92 is constantly handled as a clamp command

【#1147】 smin_V Minimum spindle rotation speed clamp type

Specify the type of spindle min. rotation speed clamp value.
 0: Rotation speed setting
 1: Output voltage coefficient setting

Set "#3023 smini" according to this type setting.

【#1148】 l_G611 Initial high precision

Set the high accuracy control mode for the modal state when the power is turned ON.
 0: G64 (cutting mode) at power ON
 1: G61.1 (high-accuracy control mode) at power ON

【#1149】 cireft Arc deceleration speed change

Select whether to decelerate at the arc entrance or exit.
 0: Not decelerate
 1: Decelerate

【#1151】 rstint Reset initial

Select whether to initialize (power ON state) the modals by resetting.
 0: Not initialize modal state
 1: Initialize modal state

【#1152】 l_G20 Initial command unit

Select inch or metric command mode at power-ON or resetting.
 0 : Metric command (G21 command state)
 1 : Inch command (G20 command state)

This selection is enabled at reset input.

Related parameter : "#1226 bit6" Set up and display unit selection

【#1153】 FixbDc Hole bottom deceleration check

Select whether to perform a deceleration check or in-position check at the hole bottom in a hole drilling cycle. This parameter is enabled only for a hole drilling cycle in which no dwell command can be issued at the hole bottom.
 0: Perform no deceleration check and in-position check
 1: Perform deceleration check
 2: Perform in-position check

【#1154(PR)】 pdoor Door interlock II (for each system)

Select whether to control door interlock II independently for each of the two part systems. When door interlock II is controlled for each system of the two part systems, system 1 is connected to SV1 (channel 1) of the base I/O unit and system 2 is connected to SV2 (channel 2) of the base I/O unit.

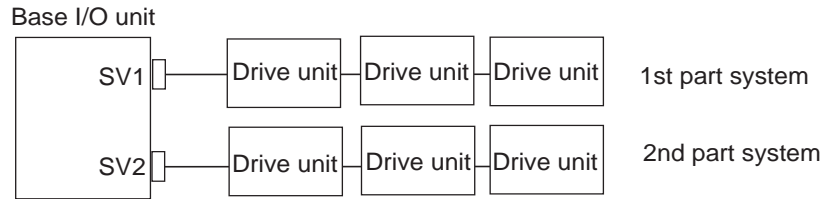

When the auxiliary axis (MR-J2-CT) is used, connect it to the SV2 side (after the spindle). This validates door interlock II of system 2.

- 0: Not use door interlock II independently for channels
- 1: Use door interlock II independently for channels (Separate systems when using two systems)
- 2: Use door interlock II independently for channels (Use independently for system 1 channels)
(Use both for system 2)

Setting "0" enables the signal input device 1 and 2 for door interlock II ("#1155 DOOR_m" and "#1156 DOOR_s"). Setting "1" enables signal input device 1 and 2 for door interlock II: for each system ("#1511 DOORPm" and "#1512 DOORPs").

【#1155】 DOOR_m Signal input device 1 for door interlock II (Common for part systems)

Set a fixed device number (X**) for door interlock II signal input (Common for part systems).
Set "100" when not using the fixed device number for door interlock II.
Setting "000" disables this parameter.

Related parameter: "#1154 pdoor Door interlock II (for each system)"

---Setting range---

001 to 2FF (hexadecimal)

【#1156】 DOOR_s Signal input device 2 for door interlock II (Common for part systems)

Set a fixed device number (X**) for door interlock II signal input (Common for part systems).
(Set the same value as "#1155 DOOR_m".)

Related parameter: "#1154 pdoor Door interlock II (for each system)"

---Setting range---

001 to 2FF (hexadecimal)

【#1157】 F0atr

Not used. Set to "0".

【#1158】 F0atno

Not used. Set to "0".

【#1163(PR)】 No rio

Set to "0".

【#1164(PR)】 ATS Automatic tuning function

Select whether to enable or disable the automatic tuning function.

- 0: Disable
- 1: Enable

【#1166】 fixpro Fixed cycle editing

Select a type of program dealt on the edit/program list/data in/out screen, general program fixed cycle, or machine tool builder macro program.

0: General programs can be edited, etc.

1: Fixed cycles can be edited, etc.

Password No.: The machine tool builder macro programs can be edited, etc.

---Setting range---

0 to 99999999

【#1167】 e2rom

Not used. Set to "0".

【#1168】 test Simulation test

Select the test mode for the control unit.

In the test mode, test is performed with a hypothetical reference position return complete even though the real reference position return hasn't been completed. This is limited to test operation of the control unit itself, and must not be used when the machine is connected.

0: Normal operation mode

1: Test mode

【#1169】 part system name Part system name

Set the name of each part system.

This must be set only when using multi-part system.

This name will be displayed on the screen only when the part systems must be identified.

Use a max. of four alphabetic characters or numerals.

---Setting range---

A max. of four alphabetic characters or numerals.

【#1170】 M2name Second miscellaneous code

Set this address code when using the 2nd miscellaneous command. Set an address with A, B or C that is not used for "#1013 axname" or "#1014 incax".

---Setting range---

A, B, C

【#1171】 taprov Tap return override

Set the tap return override value for the synchronous tapping.

When "0" is set, it will be regarded as 100%.

---Setting range---

0 to 100 (%)

【#1172】 tapovr Tap return override

Set the override value when leaving the tap end point in the synchronous tapping cycle.

The setting range is 1 to 999, and the unit is %.

When a value less than 100 is set, it will be judged as 100%.

---Setting range---

1 to 999 (%)

【#1173】 dwlskp G04 skip condition

Set the skip signal for ending the G04 (dwell) command.

PLC interface input signal

	Skip3	Skip2	Skip1
0 :	-	-	-
1 :	-	-	*
2 :	-	*	-
3 :	-	*	*
4 :	*	-	-
5 :	*	-	*
6 :	*	*	-
7 :	*	*	*

(* : Enable - : Disable)

【#1174】 skip_F G31 skip speed

Set the feedrate when there is no F command in the program at G31 (skip) command.

---Setting range---

1 to 999999 (mm/min)

【#1175】 skip1 G31.1 skip condition

Designate the skip signal in multi-step skip G31.1.

The setting method is same as "#1173".

【#1176】 skip1f G31.2 skip speed

Set the skip feedrate in multi-step skip G31.1.

---Setting range---

1 to 999999 (mm/min)

【#1177】 skip2 G31.2 skip condition

Set the skip signal in multi-step skip G31.2.

The setting method is same as "#1173".

【#1178】 skip2f G31.2 skip speed

Set the skip signal in multi-step skip G31.2.

---Setting range---

1 to 999999 (mm/min)

【#1179】 skip3 G31.3 skip condition

Set the skip signal in multi-step skip G31.3

The setting method is same as "#1173".

【#1180】 skip3f G31.3 skip speed

Set the skip signal in multi-step skip G31.3.

---Setting range---

1 to 999999 (mm/min)

【#1181】 G96_ax Constant surface speed axis

Select the axis to be targeted for constant surface speed control.

0: Program setting will be disabled, and the axis will always be fixed to the 1st axis

1: 1st axis

2: 2nd axis

3: 3rd axis

:

8: 8th axis

However, when set to other than "0", the priority will be on the program setting.

【#1182】 thr_F Thread cutting speed

Set the screw cut up speed when not using chamfering in the thread cutting cycle.
 0: Cutting feed clamp feedrate
 1 to 60000 mm/min: Setting feedrate

---Setting range---
 0 to 60000 (mm/min)

【#1183】 clmp_M M code for clamp

Set the M code for C axis clamp in hole drilling cycle.

---Setting range---
 0 to 99999999

【#1184】 clmp_D Dwelling time after outputting M code for unclamp

Set the dwell time after outputting the M code for C axis unclamp in hole drilling cycle.

---Setting range---
 0.000 to 99999.999 (s)

【#1185】 spd_F1 F1 digit feedrate F1

Set the feedrate for the F command in the F 1-digit command ("#1079 F1digit" is set to "1").
 Feedrate when F1 is issued (mm/min)

---Setting range---
 1 to 60000 (mm/min)

【#1186】 spd_F2 F1 digit feedrate F2

Set the feedrate for the F command in the F 1-digit command ("#1079 F1digit" is set to "1").
 Feedrate when F2 is issued (mm/min)

---Setting range---
 1 to 60000 (mm/min)

【#1187】 spd_F3 F1 digit feedrate F3

Set the feedrate for the F command in the F 1-digit command ("#1079 F1digit" is set to "1").
 Feedrate when F3 is issued (mm/min)

---Setting range---
 1 to 60000 (mm/min)

【#1188】 spd_F4 F1 digit feedrate F4

Set the feedrate for the F command in the F 1-digit command ("#1079 F1digit" is set to "1").
 Feedrate when F4 is issued (mm/min)

---Setting range---
 1 to 60000 (mm/min)

【#1189】 spd_F5 F1 digit feedrate F5

Set the feedrate for the F command in the F 1-digit command ("#1079 F1digit" is set to "1").
 Feedrate when F5 is issued (mm/min)

---Setting range---
 1 to 60000 (mm/min)

【#1190(PR)】 s_xcnt Validate inclined axis control (for L system only)

Select whether to enable or disable inclined axis control.
 0: Disable inclined axis control
 1: Enable inclined axis control

【#1191(PR)】 s_angl Inclination angle (for L system only)

Set the inclination angle (θ).

(Note) When set to "0", the angle determined by three-side setting will be applied.

---Setting range---

-80.000 to 80.000 (°)

【#1192(PR)】 s_zrmv Compensation at reference position return (for L system only)

Select whether to perform compensation for the base axis corresponding to the inclined axis at reference position return.

0: Perform compensation

1: Not perform compensation

【#1193】 inpos Deceleration check method 1/ Validate in-position check

The definitions are changed with the setting of "#1306 InpsTyp Deceleration check specification type".

<When Deceleration check method 1 is selected>

Select the deceleration check method for G0.

0: Command deceleration check

1: In-position check

<When Deceleration check method 2 is selected>

Select the deceleration confirmation method for the positioning or cutting command.

0: G0, G1+G9 Command deceleration check

1: G0, G1+G9 In-position check

【#1194】 H_acdc Time constant 0 for handle feed

Select the time constant for manual handle feed.

0: Use time constant for G01

1: Time constant 0 (step)

【#1195】 Mmac Macro call for M command

Select whether to enable or disable M command macro call of user macro.

0: Disable

1: Enable

【#1196】 Smac Macro call for S command

Select whether to enable or disable S command macro call of user macro.

0: Disable

1: Enable

【#1197】 Tmac Macro call for T command

Select whether to enable or disable T command macro call of user macro.

0: Disable

1: Enable

【#1198】 M2mac Macro call with 2nd miscellaneous code

Select whether to enable or disable 2nd miscellaneous command macro call of user macro.

0: Disable

1: Enable

【#1199】 Sselect Select initial spindle control

Select the initial condition of spindle control after power is turned ON.

0: 1st spindle control mode (G43.1)

1: Selected spindle control mode (G44.1)

2: All spindle simultaneously control mode (G47.1)

(Note) Spindle No. when G44.1 is commanded is selected with "#1534 SnG44.1".

【#1200(PR)】 G0_acc Validate acceleration and deceleration with inclination constant G0

Select the acceleration and deceleration type when a rapid traverse command is issued.

- 0: Acceleration and deceleration with constant time (conventional type)
- 1: Acceleration and deceleration with a constant angle of inclination

(Note) When rapid traverse constant inclination multi-step acceleration/deceleration is valid, this parameter will be invalid.

【#1201(PR)】 G1_acc Validate acceleration and deceleration with inclination constant G1

Select the acceleration and deceleration type when a linear interpolation command is issued.

- 0: Acceleration and deceleration with constant time (conventional type)
- 1: Acceleration and deceleration with a constant angle of inclination

【#1202】 mirofs Distance between facing turrets (for L system only)

Set the distance between tools (edges) (between facing turrets).

---Setting range---

0 to 99999.999 (mm)

【#1203】 TmirS1 Select turrets as facing turrets with T command (for L system only)

Select the turrets, which correspond to the tool Nos. 1 to 32, as facing turrets for T code mirror image.

---Setting range---

0 to FFFFFFFF

【#1204】 TmirS2 Select turrets as facing turrets with T command (for L system only)

Select the turrets, which correspond to the tool Nos. 33 to 64, as facing turrets for T code mirror image.

---Setting range---

0 to FFFFFFFF

【#1205】 G0bdcc Acceleration and deceleration before G0 interpolation

0: Post-interpolation acceleration/deceleration is applied to G00.

1: Pre-interpolation acceleration/deceleration is applied to G00 even in the high accuracy control mode.

2: Rapid traverse constant inclination multi-step acceleration/deceleration is enabled.

(Note) Set "0" for the 2nd part system and the following.

【#1206】 G1bF Maximum speed

Set a cutting feedrate when applying pre-interpolation acceleration/deceleration.

When high-accuracy control time constant expansion is valid, set the maximum of cutting feed clamp speed of each axis.

---Setting range---

1 to 999999 (mm/min)

【#1207】 G1btL Time constant

Set a cutting feed time constant when applying pre-interpolation acceleration/deceleration.
When set to "0", the time constant will be clamped at 1ms.

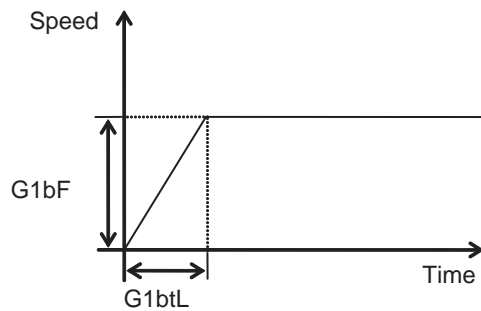

---Setting range---

Without high-accuracy control time constant expansion: 0 to 5000 (ms)
With high-accuracy control time constant expansion: 0 to 30000 (ms)

【#1208】 RCK Arc radius error compensation factor

Set a coefficient for arc radius error compensation.
An arc radius error compensation amount can be increased or decreased between -60.0 and +20.0%.

---Setting range---

-60.0 to +20.0 (%)

【#1209】 cirdcc Arc deceleration speed

Set the deceleration speed at the arc entrance or exit.

---Setting range---

1 to 999999 (mm/min)

【#1210】 RstGmd Modal G code reset

Select whether to initialize G code group modals and H and D codes, which corresponds to bits as follows, when the system is reset.

0: Initialize

1: Not initialize

-----Description of bits for M system-----

1F	1E	1D	1C	1B	1A	19	18	17	16	15	14	13	12	11	10
0	0	0	0	0	0	*	*	0	0	0	0	*	*	*	*
F	E	D	C	B	A	9	8	7	6	5	4	3	2	1	0
0	*	0	*	*	0	*	0	*	*	*	*	0	*	*	*

bit 1F: (Not used)

bit 1E: (Not used)

bit 1D: (Not used)

bit 1C: (Not used)

bit 1B: (Not used)

bit 1A: (Not used)

bit 19: Spindle clamp rotation speed initialization

bit 18: H, D codes initialization

bit 17: (Not used)

bit 16: (Not used)

bit 15: (Not used)

bit 14: (Not used)

bit 13: Group 20 2nd spindle control modal initialization

bit 12: Group 19 G command mirror modal initialization

bit 11: Group 18 Polar coordinate command modal initialization

bit 10: Group 17 Constant surface speed control command modal initialization

bit F: (Not used)

bit E: Group 15 Normal line control modal initialization

bit D: (Not used)

bit C: Group 13 Cutting modal initialization

bit B: Group 12 Workpiece coordinate system modal initialization

bit A: (Not used)

bit 9: Group 10 Fixed cycle return command modal initialization

bit 8: (Not used)

bit 7: Group 8 Length compensation modal initialization

bit 6: Group 7 Radius compensation modal initialization

bit 5: Group 6 Inch/metric modal initialization

bit 4: Group 5 Feed G modal initialization

bit 3: (Not used)

bit 2: Group 3 Absolute/incremental command modal initialization

bit 1: Group 2 Plane selection modal initialization

bit 0: Group 1 Move G modal initialization

The H code indicates the tool length offset number, and the D code indicates the tool radius compensation number.

When bit 18 is set to ON, the H and D codes and group 8 G modal are retained.

When bit 7 is set to ON, the H code and group 8 G modal are retained.

-----Description of bits for L system-----

1F	1E	1D	1C	1B	1A	19	18	17	16	15	14	13	12	11	10
0	0	0	0	*	*	*	0	0	0	0	*	*	0	*	*
F	E	D	C	B	A	9	8	7	6	5	4	3	2	1	0
0	0	0	*	*	0	*	0	0	*	*	*	*	*	*	*

bit 1F: (Not used)

bit 1E: (Not used)

bit 1D: (Not used)

bit 1C: (Not used)

bit 1B: Group 22 Groove width compensation

bit 1A: Group 21 Automatic tool nose R compensation

bit 19: Spindle clamp rotation speed initialization

bit 18: (Not used)

bit 17: (Not used)

bit 16: (Not used)

bit 15: (Not used)

bit 14: (Not used)

bit 13: Group 20 2nd spindle control modal initialization

bit 12: (Not used)

bit 11: Group 18 Balance cut initialization

bit 10: Group 17 Constant surface speed control command modal initialization

bit F: (Not used)

bit E: Group 15 Mirror image for facing tool post

bit D: (Not used)

bit C: Group 13 Cutting modal initialization

bit B: Group 12 Workpiece coordinate system modal initialization

bit A: (Not used)

bit 9: Group 10 Fixed cycle return command modal initialization

bit 8: (Not used)

bit 7: (Not used)

bit 6: Group 7 Nose R compensation modal initialization

bit 5: Group 6 Inch/metric modal initialization

bit 4: Group 5 Feed G modal initialization

bit 3: Group 4 Barrier check modal initialization

bit 2: Group 3 Absolute/incremental command modal initialization

bit 1: Group 2 Plane selection modal initialization

bit 0: Group 1 Move G modal initialization

【#1211】 FHtyp Feed hold stop type

Select the type of the external signal used for feed hold.

- 0: Disable the external signal.
- 1: Enable the external signal (contact A)
- 2: Enable the external signal (contact B)

---Setting range---
0 to 2

【#1212】 FHno Feed hold external signal device

Set the device No. (X**) used to input the feed hold signal.

---Setting range---
000 to 13F (hexadecimal)

【#1213(PR)】 proaxy Side 1 of inclination angle (for L system only)

Set the length within the orthogonal coordinate of the inclined axis, a side of the triangle formed with the inclination angle.

---Setting range---
-9999.999 to 9999.999

【#1214(PR)】 macaxy Side 2 of inclination angle (for L system only)

Set the actual length of the base axis corresponding to the inclined axis, a side of the triangle formed with the inclination angle.

---Setting range---
-9999.999 to 9999.999

【#1215(PR)】 macaxx Side 3 of inclination angle (for L system only)

Set the actual length of the inclined axis, a side of the triangle formed with the inclination angle.

---Setting range---
-9999.999 to 9999.999

【#1216】 extdcc External deceleration level

Set the upper limit value of the feedrate when the external deceleration signals are enabled.
This parameter is valid when "#1239 set11/bit6" is set to "0".

---Setting range---

1 to 999999 (mm/min)

【#1217】 aux01

Not used. Set to "0".

【#1218】 aux02**bit3: Parameter input/output format**

Select the parameter input/output format.

0: Type I

1: Type II (related to "#1218 aux02/bit5")

bit4: External workpiece coordinate offset tool number selection

Select the R register that contains the tool number used for automatic calculation when measuring the coordinate offset of an external workpiece.

0: Follow the setting of "#1130 set_t".

1: Use the tool number indicated by user PLC.

bit5: Parameter I/O II spindle specification address

Select the spindle specification address of parameter I/O type II.

0: C

1: T

This parameter is also applied to the spindle specification address for input and verification.

(Note) This parameter is valid only for parameter I/O type II (when "#1218 aux02/bit3" is set to "1").

bit6: Set No. valid when program input

Select which program No. is applied when inputting programs in "#1 MAIN PROGRAM" on Data I/O screen.

0: The No. in the input data

1: The No. set in the data setting area

bit7: Input by program overwrite

(1) Select the operation when the program to be input in "#1 MAIN PROGRAM" on Data I/O screen, has already been registered.

0: An operation error (E65) occurs.

1: Input by overwrite.

(2) Select the operation in the high-speed program server mode, when the name of the file to be transmitted with (IC -> host) transmission already exists in the host.

0: Prohibit overwrite

1: Enable overwrite

【#1219】 aux03**bit1: Stop high-speed PC monitoring function**

Set "1" to disable the function that triggers the emergency stop when the PC high-speed processing time is extended.

Disable the monitoring function only as a temporary measure.

bit2: Improve skip coordinate accuracy

Select whether to enable the skip coordinate correction at skip signal's ON.

0: Disable (as conventional specifications)

1: Enable

bit5: Dog-type intermediate point

Select whether to move to the intermediate point during automatic dog-type reference position return.

0: Not move

1: Move

bit7: Time constant setting changeover for soft acceleration/deceleration

0: Accelerating time is $G0tL(G1tL)$.

When the G00 pre-interpolation acceleration/deceleration and the soft acceleration/deceleration are used together, the inclination of soft acceleration/deceleration will be steeper by setting a time to the soft acceleration/deceleration 2nd step time constant (#2005 G0t1). Consequently, the acceleration for G28/G30 will be larger than that for G00.

- (1) Total accelerating time is "G0tL".
- (2) The time for curve part is "G0t1".
- (3) The time for linear part is obtained by " $G0tL - (2 \times G0t1)$ ".

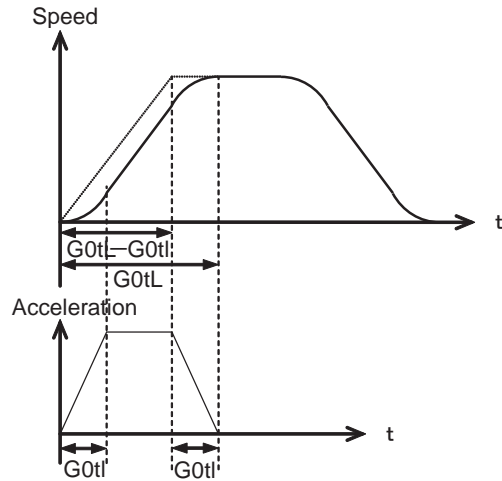

1: Accelerating time is obtained by $G0tL+G0t1 (G1tL+G1t1)$.

When the G00 pre-interpolation acceleration/deceleration and the soft acceleration/deceleration are used together, you can attain the G28/G30 acceleration that is equal to G00, by setting the same value to G00 soft acceleration/deceleration filter (#1569 SfiltG0) as well as to the soft acceleration/deceleration 2nd step time constant (#2005 G0t1).

- (1) Total accelerating time is obtained by " $G0tL+G0t1$ ".
- (2) The time for curve part is "G0t1".
- (3) The time for linear part is obtained by " $G0tL-G0t1$ ".

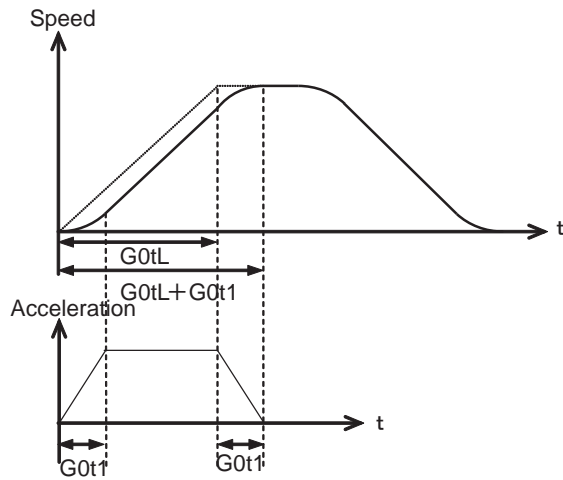

【#1220】 aux04**bit0 : Tool life check timing selection (for L system only)**

Select the life check standard applicable when the use count is incremented in tool life management II.

- 0: Determine that the tool life is over when the incremented use count exceeds the life count. (as default) (Use count > life count)
- 1: Determine that the tool life is over when the incremented use count has reached the life count. (Use count \geq life count)

bit1: Enable space code in comment

Select whether to enable space codes in comment statements when editing machining programs on the special display.

- 0: Disable (as default)
- 1: Enable

bit4: Data input/output unit selection

Select the data unit for the input/output of tool data and user parameters.

- 0: Follows "#1041 I_inch", the unit setting.
- 1: Follows "#1152 I_G20", the command mode setting. Applies metric system when "#1152 I_G20" is set to "0", inch system when set to "1".

This parameter is enabled when initial metric system is applied ("#1041 I_inch" is set to "0") and the command unit is applied for setting and display unit ("#1226 aux10/bit6" is set to "1"). In any other cases, the tool data will be input/output with the units set by "#1041 I_inch".

bit7: Enable host communication during automatic operation

Select whether to enable the Ethernet communication during automatic operation.

- 0: Disable the Ethernet communication during automatic operation
- 1: Enable the Ethernet communication during automatic operation

(Note) Enabling the Ethernet communication means to allow the required interruptions during automatic operation, which may lower the machining performance.

【#1221】 aux05**bit7: Current value B valid (for L system only)**

Select the type of the counter displayed on the POSITION screen.

- 0: Displays a relative value (value that includes tool length offset amount, tool radius compensation amount and workpiece coordinate offset amount)
- 1: Displays a current position value B (value that excludes tool length offset amount, tool radius compensation amount and workpiece coordinate offset amount)

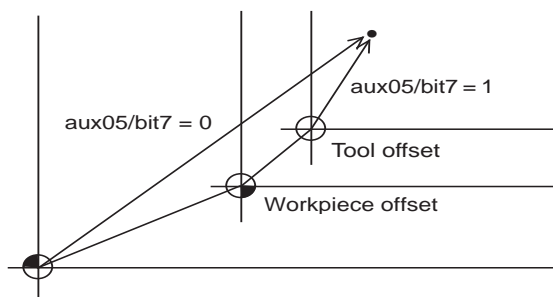

(Note 1) When "#1221 aux05/bit7" is set to "1", a current value B is displayed regardless of the "#1287 ext23" bit settings. When the current value B display is enabled, counter zero and origin zero are disabled.

(Note 2) Even the relative position counter on the coordinate position screen displays a current position B.

(Note 3) When "#1287 ext23/bit3" is set to "0", a relative position will be displayed instead of a current position B regardless of this parameter setting.

【#1222】 aux06

bit0: Enable tool length measurement confirmation message

Select whether to display a confirmation message at the setting of the tool compensation data.
 0: Not display
 1: Display

bit1: Height axis specification

Select the axis for tool measurement.
 0: The axis that has moved at the sensor's ON
 1: The axis designated by "#1028 base_K"

bit3: Enable setup parameter lock

Select whether to enable the setup parameter lock.
 0: Disable
 1: Enable

bit4: Minimum cut-in amount selection

Select the minimum cut-in amount command value for the compound thread cutting cycle (G76 command) without Q command.
 0: The minimum cut-in amount (Q) will be "0"
 1: The minimum cut-in amount (Q) will be the set value of "#8061 G76 minimum cut-in".

bit5: Fixed cycle for compound lathe command format check selection

Select the operation when the 1st block of the fixed cycle for compound lathe is omitted while the conventional format is selected ("#1265 ext01/bit0" is set to "0").
 0: Program error (P33) will occur
 1: Parameter setting value will be used

bit7: Reference position return deceleration check method

Select the deceleration check method to be used during automatic reference position return.
 0: In-position check
 1: Commanded deceleration check

【#1223】 aux07

bit1: Deceleration check method 2

Select the deceleration check method in G1+G9.
 0: Command deceleration check in G1+G9
 1: Command in-position check in G1+G9

The deceleration check is not performed except G1+G9.
 This parameter will be disabled when "#1306 InpsTyp (Deceleration check specification type)" is set to "1" (deceleration check specification type 2).

bit6: Cancel synchronous tap (,S) return

0: Retain a spindle rotation speed (, S) when performing synchronous tap return
 1: Cancel a spindle rotation speed (, S) in returning with G80

bit7: Synchronous tap method

Select the synchronous tap method.
 0: Synchronous tapping with multi-step acceleration and rapid return
 1: Conventional synchronous tap

【#1224】 aux08

bit0: Sampling data output

Select whether to enable the sampling data output.
 0: Disable
 1: Enable

bit5: Disable axis position monitoring

Select whether to disable the axis position monitoring.
 0: Enable (as default)
 1: Disable
 (Note) Normally set "0" in this parameter.

【#1225】 aux09**bit4: Recording "stop code" in alarm history (For special display unit)**

Select whether to record stop codes in the alarm history on a special display unit.

0: Not record

1: Record

bit5: Registration changeover for alarm history of safety observation alarm

Select whether to record "Y21 Safety observation warning 0001"(Speed obsv signal: Speed over) into the alarm history.

0: Record

1: Not record

bit6: Enable/disable spindle rotation speed clamp 2

Specify whether to enable spindle rotation speed clamp by the spindle rotation speed clamp command (G92 Q) for the spindle rotation speed command (R7000) set by the user ladder.

0: Follows "#1225 aux09/bit7" setting

1: Enable only G92 S for R7000. Disable G92 Q.

When this parameter is set to "1", setting of "#1225 aux09/bit7" is disabled.

bit7: Enable/disable spindle rotation speed clamp

Specify whether to enable spindle rotation speed clamp by the spindle rotation speed clamp command (G92 S, Q) for the spindle rotation speed command (R7000) set by the user ladder.

0: Enable

1: Disable

[#1226] aux10

bit0: Tool compensation data for external workpiece coordinate offset measurement

Select the tool compensation data to use for external workpiece coordinate offset measurement.
 0: Tool length data and tool nose wear data
 1: Tool length data

bit1: Optional block skip type

Select whether to enable optional block skipping in the middle of a block.
 0: Enable block skipping only at the beginning of a block.
 1: Enable block skipping at the beginning of the block and in the middle of a block.

bit2: Single block stop timing

Select the time at which the single block signal is activated.
 0: The block stops upon its completion when the signal goes ON during automatic operation.
 1: The block stops upon the signal's ON at the end of the block.

bit3: C-axis reference position return type

Select the C-axis reference position return type.
 0: Reference position return is performed by G28 reference position return command or manual reference position return. Origin dog is used.
 1: Reference position return is performed before the execution of the block with the first C-axis command since the shift to C-axis mode in automatic mode. Reference position return is also performed by G28 reference position return command or manual reference position return. The Z phase of the encoder is used.

bit4: S command during constant surface speed

Select whether to output the strobe signal for the S command in constant surface speed mode.
 0: Not output the strobe signal in constant surface speed mode
 1: Output the strobe signal in constant surface speed mode

bit5: Arbitrary allocation of dog signal

Select whether to enable the arbitrary allocation parameter for the origin dog and H/W OT.
 0: Disable (Fixed devices are enabled)
 1: Enable (Devices are set by parameters)

bit6: Setting and display unit selection

Select command/internal unit to use as the setting and display unit or as the handle feed unit.
 0: Internal unit
 1: Command unit
 (Note 1) This parameter is enabled only in initial metric system (with "0" in "#1041 I_inch"). Internal unit is always used in initial inch system (with "1" in "#1041 I_inch").
 (Note 2) Setting of this parameter is immediately enabled.
 (Note 3) If the command unit is inch while the internal unit is mm, an addition setting of tool or workpiece offset data may generate an error.
 (Note 4) If "1" is set for this parameter in multi-part system, the operation applies the command unit in each part system.
 (Note 5) For internal data, the internal unit determined by "#1041 I_inch" is applied.
 (Note 6) This parameter is not related to PLC axis.
 Related parameters: "#1152 I_G20 (Initial command unit)"

bit7: Shorten JOG stop time

Select whether to shorten the JOG stop time.
 0: Not shorten the time (conventional method)
 1: Shorten the time

【#1227】 aux11**bit0: Select PLC signal or spindle feedrate attained**

Set up this option when disabling the cutting start interlock by spindle feedrate attained.

- 0: Cutting start interlock by PLC signal
- 1: Cutting start interlock by spindle feedrate attained

bit1: Select H or D code

Set up this option to validate the data that is set up on the tool life management screen when issuing the H99 or D99 command.

- 0: The H and D codes validate the data that is set up on the management setup screen.
- 1: Validates the data that is set up on the management setup screen when issuing the H99 or D99 command.

bit2: Measures against tool setter chattering

Select a condition where a relieving operation completes after measurement with tools.

- 0: Sensor signals have stopped for 500 ms or longer.
- 1: 100 μ s or longer has passed after sensor signals stopped.

bit3: Absolute coordinate switching (nose R)

Select whether to display a nose position or coordinate value with the absolute coordinate counter.

- 0: Displays the nose position
- 1: Displays the position specified by program command

bit4 : Program address check

Specify whether to simply check the program address when the machining program is executed.

- 0: Don't check the program address.
- 1: Check the program address.

bit5: Spindle rotation speed clamp

Specify whether to clamp the rotation speed in constant surface speed mode when the spindle rotation clamp command is issued.

- 0: Clamps the rotation regardless of the constant surface speed mode.
- 1: Clamps the rotation only in constant surface speed mode.

bit7: Switch the range of tool life data to be input

Set up the range of tool life data to be input or compared.

- 0: Inputs or compares all of the data output.
- 1: Inputs or compares part of the data output.

- 1) Tool life management I data to be input or compared tool number (D), lifetime (E), life count (F), and auxiliary data (B)
- 2) Tool life management II data to be input or compared Group number (G), method (M), life (E/F), tool number (D), and compensation number (H)

【#1228】 aux12

bit1: Switch "offset and parameter" screen

Select to switch the "offset and parameter" screen to the parameter screen.
 0: Display the "offset and parameter" screen.
 1: Display the "parameter" screen.

bit2: Switch data protection in data transmission mode

Select the range of data protection in data transmission mode.
 0: Enable the protection for both send and receive data.
 1: Enable the protection for receive data only.

bit3: Nose R specification

Select the method to specify the nose R compensation.
 0: Specify the nose R compensation by shape number.
 1: Specify the nose R compensation by wear number.

bit4: Select operation error or stop code

Select operation error or stop code to provide for both block start and cutting start interlocks.
 0: Operation error
 1: Stop code

bit5: Select constant surface speed coordinates

Select the constant surface speed coordinate.
 0: Workpiece coordinate
 1: Absolute value coordinate

bit6: Switch relative values displayed

Select whether to preset the relative coordinates with workpiece coordinate preset (G92.1) or counter preset (G92).
 0: Preset the relative coordinates.
 1: Not preset the relative coordinates.

bit7: Protection with manual value command

Select whether to protect a manual value command.
 0: Not protect. (Conventional specification)
 1: Protect.

【#1229】 set01**bit0: Subprogram interrupt**

Select the type of the user macro interrupt.
 0: Macro type user macro interrupt
 1: Sub-program type user macro interrupt

bit1: Accurate thread cutting E

Select what the address E specifies in inch screw cutting.
 0: Number of threads per inch
 1: Precision lead

bit2: Radius compensation type B (for M system only)

Select the method of the arithmetic processing for the intersection point when the start-up or cancel command is operated during radius compensation.
 0: The processing does not handle the start-up or cancel command block: handle the offset vector in the direction vertical to that of the command instead.
 1: The processing is executed for the intersection point between the command block and the next block.

bit2: Nose R compensation type B (for L system only)

Select the method of the arithmetic processing for the intersection point when the start-up or cancel commands are operated during nose R or radius compensation.
 0: The processing does not handle the start-up or cancel command block: handle the offset vector in the direction vertical to that of the command instead.
 1: The processing is executed for the intersection point between the command block and the next block.

bit3: Initial constant surface speed

Select the initial state after the power-ON.
 0: Constant surface speed control cancel mode
 1: Constant surface speed control mode

bit4: Synchronous tap

Select the operation when ",R" is omitted in G74/G84 tapping cycle.
 0: Asynchronous tap
 1: Synchronous tap

bit5: Start point alarm

Select the operation when the operation start point cannot be found while executing the next block of G117.
 0: Enables the auxiliary function after the block has been executed.
 1: Outputs the program error (P33).

bit6: Grid display selection

Select the grid display type on the servo monitor screen during the dog type reference position return.
 0: Distance between dog OFF and basic point (including a grid mask amount)
 1: A value given by reducing a grid mask amount from the distance between dog OFF and basic point

【#1230】 set02**bit7: Macro interface input/output for each part system**

Select the specification of the macro interface input/output.
 0: Shared by all part systems.
 1: Used independently by the part systems.

【#1231】 set03

bit0: Graphic check compatibility parameter

Select whether to return the data to the pre-starting data after having checked a machining program that rewrites the common variables, workpiece offsets and tool offsets.

- 0: Return the data
- 1: Not return the data

bit1: Switch graphic trace coordinates

Select whether to use machine coordinate value or tool position coordinate value (position being machined, obtained by subtracting the tool compensation amount from machine coordinate values) for drawing with trace display.

- 0: Machine coordinate value (conventional method)
- 1: Tool position coordinate value

Counter display and counter name are sequenced with this setting.

bit2: Switch graphic check trace

Select the coordinates to draw at program check: both machine coordinate value (tool center path) and tool position coordinate value (program path) simultaneously, or only the coordinates selected with "#1231 set03/bit1 (Switch graphic trace coordinates)".

- 0: Both machine coordinates and tool position coordinates (conventional method)
- 1: Only coordinates designated with switch graphic coordinates

bit3: Hold display range information

Select whether to hold the display range information (drawing position and scale value) for graphic displays.

- 0: Hold
- 1: Not hold (Initialize each time as conventional method)

bit4: Switch zero point mark display position

Select the zero point mark display position in the graphic trace 2D check.

- 0: Machine coordinate zero point (conventional method)
- 1: Workpiece coordinate zero point

bit5: Switch graphic check counter display

Select the type of the counter displayed on Graphic Check screen.

- 0: Machine position counter
- 1: Workpiece coordinate position counter

【#1232】 set04

bit0: Switch load monitor

Select whether to exclude the load during acceleration/deceleration from the load detected by the load monitor.

- 0: Include the load during acceleration/deceleration in the detected load (conventional method)
- 1: Exclude the load during acceleration/deceleration from the detected load.

bit1: Program format

Select whether to add "%+CR+LF" to the head of the file when outputting a machining program. (only for the output from memory device)

- 0: Add "%"
- 1: Not add "%"

bit4: Load monitor Enabled part system selection

In two-part system, select whether to use the load monitor in both part systems or in a single part system.

- 0: Use load monitor in both two part systems. (128 points are used in each part system for the teaching data) (default setting)
- 1: Use load monitor in the first part system only even in two-part system. (256 points are used for the teaching data)

bit5: Actual load selection

Select the type of load to be targeted for teaching and monitoring.

- 0: Load of the commanded current is monitored
- 1: Load of the feedback current is monitored

【#1233】 set05**bit1: Spindle clamp selection**

Select whether to enable the spindle override for the spindle speed clamp command (G92 S?).

- 0: Disable the spindle override
- 1: Enable the spindle override

bit2: Enable alarm display in axis position monitoring

Select whether to enable alarm display (and block stop) when an illegal axis position is detected in the axis position monitoring.

- 0: Disable (Not execute alarm display nor block stop) (as default)
 - 1: Enable (Execute alarm display block stop)
- Normally set "0" for this parameter.

bit3: Enable axis position correction

Select whether to enable the axis position correction.

- 0: Disable (as default)
 - 1: Enable
- Normally set "0" for this parameter.

bit4: Data sampling valid with special display unit

Select whether to enable the data sampling with a special display.

- 0: Disabled the sampling specification
- 1: Enabled the sampling specification

【#1234】 set06**bit3: Interlock when tap retract enabled**

Select whether to enable automatic/manual interlock for the part system with "Tap retract enable" signal ON.

- 0: Interlock all the axes
- 1: Disable the interlock

bit4: Signal to cancel tap retract

Select an operation after the tap retract enabled signal(TRVE) is turned OFF with the tap retract enabled state cancel signal(TRVEC).

- 0: The tap retract enabled signal(TRVE) is ON after reset.
- 1: The tap retract enabled signal(TRVE) stays OFF after reset.

bit7: Disable MELDASNET

Select whether to disable the MELDASNET functions.

- 0: Enable
- 1: Disable

【#1235】 set07**bit0: Helical interpolation speed 2**

- 0: Select normal speed designation also for 3rd axis
- 1: Select arc plane element speed designation

bit4: Selection condition of synchronous tapping gear step

Select the parameters that determine the gear step for synchronous tapping.

- 0: #3005 through #3008 (smax1 to 4) when "#1223 aux07/bit7" is "0".
Or #3013 through #3016 (stap1 to 4) when "#1223 aux07/bit7" is "1".
- 1: Always #3013 through #3016 (stap1 to 4)

【#1236】 set08

bit0: Manual rotary axis feedrate unit

Select the unit of manual rotary axis feedrate.

0: Fixed to [deg/min]

1: Same speed as before (When inch command, the speed is the command speed divided by 25.4.)

bit1: Spindle speed detection

Select the pulse input source of actual spindle rotation speed (R6506/R6507) when the spindle encoder serial connection is selected ("#3025 enc-on" is set to "2").

0: Serial input

1: Encoder input connector

bit2: Current limit droop cancel invalid

Select whether to cancel the position droop when the current limit changeover signal is canceled.

0: Cancel the droop

1: Not cancel the droop

bit3: Rotary axis command speed scale

Select to multiply the rotary axis command speed by 10 times.

0: Disable

1: During initial inching, the rotary axis command speed is multiplied by 10. In other words, if "F100" is commanded, the speed will be the same as when 1000 deg/min is commanded. The rotary axis speed display unit will be 10[deg/min].

bit4: Tool setter lowest speed check disabled in handle mode

Select the condition for the lowest speed check in using tool setter.

0: The lowest contact speed is checked in handle mode as well

1: The lowest contact speed is not checked in handle mode

bit5: Lathe fixed cycle command format check

With the conventional format selected ("#1265 ext01/bit1 is set to "0"), select the operation when an address I/K is designated in the lathe fixed cycle command block.

0: The designation is ignored

1: Program error (P33) occurs

(Note) This parameter is enabled only when the conventional format is selected (with "0" in "#1265 ext01/bit1").

【#1237(PR)】 set09**bit0: External workpiece offset sign reversing**

Select this function to use the external workpiece coordinates by shifting them to the Z axis.

- 0: Not reverse the sign of external workpiece offsets (Z shift) (same as conventional)
- 1: Reverse the sign of external workpiece offsets (Z shift)

(Note) When you choose to reverse the sign of external workpiece offsets (Z shift), do not measure those external workpiece offsets. However, you can measure the external workpiece offsets using a tool pre-setter.

bit1: Switch PC I/F F modal

Select how to display the feed rate on the special display unit.

- 0: Display the feed per minute.
- 1: Display the feed per minute or feed per rotation accordingly to the modal state.

bit2: Switch PC I/F T modal (for L system only)

Select how to display T command on the special display unit.

- 0: Display tool No. (excluding the lowest two digits)
- 1: Display the data including compensation No.

bit3: Switch PC I/F remaining distance dwell time display

Select where to display dwell time on the special display unit.

- 0: In the feedrate display area
- 1: In the remaining distance display area

bit4: Switch PC I/F execution program display/ comment display

Select how to display the program in execution on the special display unit.

- 0: Display the program whenever it is searched, regardless of the operation mode
- 1: Not display when the operation mode does not correspond to the searched program Comment is displayed for head block search.

bit5: Switch PC I/F modal S

Select the modal S data to be transferred to special display unit.

- 0: The last issued S command is transferred
- 1: - When "#1039 spinno" is set to "1": The 1st spindle data is displayed.
 - When "#1039 spinno" is set to "2": The 2nd spindle data is transferred if "#1199 Sselect" is set to "1" in the 2nd part system setting. Otherwise, the 1st spindle data is transferred.

(Note) In the constant surface speed control (G96 modal), the actual rotation speed command is transferred.

【#1238(PR) set10

bit0: Switch G36 function

Select the function, the automatic tool length measurement or arc thread cutting (CCW), to be applied to G36 when the G code system 6 or 7 is selected.

- 0: Automatic tool length measurement
- 1: Arc thread cutting (CCW)

bit4: Door interlock Switch PLC axis stop confirmation

Select whether to confirm the PLC axis has been stopped before opening the door.

- 0: Not confirm
- 1: Confirm

(Note) The PLC axis stop is executed by PLC program.

bit6: Switch absolute position detection alarm

Select the output destination of the absolute position detection alarm.

- 0: NC alarm 4 (AL4)
- 1: NC alarm 5 (AL5)

(Note) The absolute position detection alarm is listed in the alarm history regardless of this parameter setting.

bit7: Switch operation alarm

Select whether to enable the NC alarm 5 (AL5) signal output.

- 0: Disable NC alarm 5 (AL5)
All operation alarms will be output to NC alarm 4 (AL4).
All operation alarms will be recorded in the alarm history.
- 1: Enable NC alarm 5 (AL5)

The following operation alarms will be output to NC alarm 5 (AL5), not to NC alarm 4 (AL4).
The operation alarms output to NC alarm 5 (AL5) will not be recorded in the alarm history.

- External interlock axis found (M01 0004)
- Manual skip interlock axis found (M01 0032)
- Cutting override zero (M01 0102)
- External feedrate zero (M01 0103)
- Block start interlock (M01 0109)
- Cutting block start interlock (M01 0110)
- Rapid traverse override zero (M01 0125)
- Cutting interlock for spindle-spindle polygon (G51.2) (M01 1033)

【#1239(PR)】 set11**bit0: Coil switching method**

Select the coil switching method.
 0: Via PLC (Y189F).
 1: NC internal processing. (Y189F is invalid.)

bit1: Handle I/F selection

Select the handle connection destination.
 0: Use the handle connected to the base I/O unit.
 1: Use the remote I/O unit.

Note that when operation board I/O unit is mounted, the handle connected to the operation board I/O unit will be used preferentially regardless of this parameter setting.

bit3: Polygon machining mode at reset

Select whether to cancel the polygon machining mode when reset is applied.
 0: Not cancel.
 1: Cancel.

bit4: Invalidate G51.1 phase command

Select whether to enable the phase control with the spindle-spindle polygon function.
 0: Always enable. (When R is not commanded, it will be handled as R0.)
 1: Enable only at the R command.

bit5: Door interlock spindle speed clamp valid

Select whether to enable the spindle clamp speed changeover by the PLC signal.
 0: Disable
 1: Enable

bit6 : External deceleration axis compliance valid

Designate the method for setting the external deceleration speed.
 0: Set speed common for all axes (#1216 extdcc external deceleration speed)
 1: Set speed for each axis (#2086 exdcax external deceleration speed)

【#1240(PR)】 set12**bit0: Handle input pulse**

Select the handle input pulse.
 0: MITSUBISHI CNC standard handle pulse (25 pulse/rev)
 1: Handle 400 pulse (100 pulse/rev)

bit1: Megatorque motor handle feed magnification

Select the magnification of megatorque motor handle feed per pulse.
 0: Use the doubled value of the magnification per pulse that is designated by the handle/incremental feed magnification code 1, 2, 4 signals.
 1: Use the magnification per pulse as designated by the handle/incremental feed magnification code 1, 2, 4 signals.

bit4:

Set to "0".

【#1241】 set13

Not used. Set to "0".

【#1242】 set14

Not used. Set to "0".

【#1243】 set15

Not used. Set to "0".

【#1244】 set16

Not used. Set to "0".

【#1245】 set17**bit7: Synchronous tap spindle rotation direction type**

Select whether the spindle's rotation direction is determined by the synchronous tapping axis' travel direction.

0: The spindle's rotation direction is determined by the synchronous tapping axis' travel direction.

When the travel direction is negative, the spindle rotates forward.

When the travel direction is positive, the spindle rotates in reverse.

1: The spindle always rotates forward regardless of the synchronous tapping axis' travel direction.

(Note)When a reverse tap is commanded, the spindle rotates in an opposite direction to that mentioned above.

【#1246(PR)】 set18**bit0 : Enable thread cutting override**

Select whether to enable spindle override during thread cutting.

0: Disable

1: Enable

bit1 : Tread cutting override feed hold

Specify whether to execute feed hold when spindle override has been changed during thread cutting.

0: Execute feed hold

1: Not execute feed hold

bit2: Switch coordinate systems for radius compensation

Select the coordinate system for radius compensation.

0: Type 1 (Conventional specification)

Perform radius compensation with reference to a position on the workpiece coordinate system.

1: Type 2

Perform radius compensation with reference to a position on the program coordinate system.

bit6 : Switch F 1-digit feedrate change method

Set whether to enable feedrate change with handle until power OFF, or change the parameters #1185 to #1189 with change of speed.

0: Enabled until power OFF

1: Change #1185 spd_F1 to #1189 spd_F5

【#1247】 set19

Set to "0".

【#1248】 set20**bit0: Variable lost motion Model acceleration changeover**

Change the calculation method to select the variable lost motion compensation amount.

0: Obtain the acceleration with the program path.

1: Obtain the acceleration with the theoretical machine operation (model).

【#1249】 set21

Not used. Set to "0".

【#1250】 set22

Not used. Set to "0".

【#1251】 set23

Not used. Set to "0".

【#1252】 set24**bit0: Enable comment copy**

Select whether to enable copying of comments at program copy.
 0: Disable (as conventional specifications)
 1: Enable

bit1: Switch over AL4 signal of reclosing alarm

Select whether to output the reclosing alarm(Z20) to NC alarm4 (AL4) signal.
 0: Not output to NC alarm4 (AL4)
 1: Output to NC alarm4 (AL4)

【#1253(PR)】 set25**bit0 : The number of definition files of the machine tool builder macro programs changeover**

Change the number of the definition files of the machine tool builder macro programs.
 0: 1 file (099999999)
 1: 10 files (099999990 ~ 099999999)

bit1 : Inch/metric changeover disabled

Select whether to enable the inch/metric changeover.
 The program error (P34) will occur when G20/G21 that changes the current command unit system (G20/G21) modal is commanded.
 0: Enabled
 1: Disabled

(Note 1) This parameter is enabled for the machine tool builder macro and user macro.

bit3 : G50G53 Same command enabled (only for L system)

Select whether to enable the G50G53 same command.
 0: Disable (the program error (P33) will occur when G50G53 same command is commanded.)
 1: Enable (the program error (P33) will occur when the axis address data is not 0. The command is enabled in 0.)

【#1254】 set26

Not used. Set to "0".

【#1255】 set27

Not used. Set to "0".

【#1256】 set28

Not used. Set to "0".

【#1257】 set29**bit0 : Log of program edit in operation history**

Select a method to record the machining program edit log in the operation history.
 The contents to be recorded are the return value of the highest-level function, the line number ID and the argument.
 0: Record when an error occurred
 1: Record constantly

bit1 : Details of program edit log in operation history

Select a method to record the details of machining program edit log in the operation history.
 The contents to be recorded are the return value of the low-level functions and the line number ID.
 0: Record when an error occurred
 1: Record constantly

bit2 : Open/close logs of operation history file

Select a method to record the result of the program open/close in the operation history.
 The content to be recorded is the file descriptor.
 0: Record when an error occurred
 1: Record constantly

【#1258(PR)】 set30

bit0: Skip I/F switch

Select A or B contact for the skip interface.
 0: A contact (Skip operation starts at rising edge of a signal)
 1: B contact (Skip operation starts at falling edge of a signal)

(Note) This parameter is not applied to PLC skip.

bit1: Excessive posn detected when Power supply on

Select whether to output the absolute position detection system alarm (Z70 0007), if the machine position at turning the power ON and OFF is bigger than the value set in "#2051 check".
 0: Not output
 1: Output

bit2: Optional block skip enabled during pre-reading

Select whether to enable the optional block skip for the block read into the pre-read buffer.
 0: Disable
 1: Enable

bit7 : PLC axis buffering mode action changeover

Select the action of rotary axis when issuing an absolute value command to the PLC axis in buffering mode.
 0 : Shift as much as the incremental amount calculated by subtracting current value from command value.
 1 : When short-cut is disabled, follow the sign of the command value. When short-cut is enabled, take a short-cut to the commanded position.

【#1259】 set31

Not used. Set to "0".

【#1260(PR)】 set32

bit6 : Machine error compensation basic position selection for spindle C axis

Select whether to include the shift amount of "#2027 G28sft" in the machine error compensation basic position.
 0: Include the shift amount of "#2027 G28sft" in the basic position.
 1: Not include the shift amount of "#2027 G28sft" in the basic position.
 *This parameter is enabled only when the following parameters are set for the spindle C.
 #3106 zrn_typ/BIT8 = 1 and
 #1226 aux10/BIT3 = 1

bit7 : Select how to store coordinates during servo OFF of spindle C axis

Select whether to store the coordinate position during servo OFF of spindle C axis. This parameter is enabled when the parameter "3106 zrn_typ/BIT8" and "#1226 aux10/BIT3" are set to "1".
 When zero point return is completed in C axis mode after the power was turned ON, the operation of setting "1" is enabled.
 0: The coordinate position is not stored during servo OFF.
 1: The coordinate position is stored during servo OFF.

【#1261】 set33

bit0 : Operation selection at address conflict

Select an operation when R registers of same address are simultaneously accessed.
 0: Alarm (U10 Illegal PLC 8Bxx)
 * User PLC is stopped.
 1: No alarm
 * The latest data writing is adopted. User PLC is not stopped.

【#1262】 set34

Not used. Set to "0".

【#1263】 set35

Not used. Set to "0".

【#1264】 set36**bit6 : Reset during DS operation**

Specify an operation after a reset of an executing program in DS.

- 0: Program search is required to continue the program in progress.
- 1: Operation can be continued continues after a reset.

bit7 : Data server program editing function

Select whether to enable the program editing function in the data server.

- 0: Disable
- 1: Enable

【#1265(PR)】 ext01**bit0: Command format 1**

Select the command format for the fixed cycle for compound lathe.

- 0: Conventional format
- 1: MITSUBISHI CNC special format (1 block command method)

bit1: Command format 2

Select the command format for the lathe fixed cycle.

- 0: Conventional format
- 1: MITSUBISHI CNC special format

bit2: Command format 3

Select the command format for the hole drilling fixed cycle.

- 0: Conventional format
- 1: MITSUBISHI CNC special format

bit3: F-command unit 2 (for L system only)

Select the command unit to apply when there is no decimal point in a synchronous feed/ thread cutting lead command.

- 0: Type 1 (conventional specifications) or Type 2
"#1271 ext07/bit2 (F-command unit)" decides which type is used.
- 1: Type3

Synchronous feed
 F command 0.01 mm/rev, 0.0001 inch/rev
 E command 0.01 mm/rev, 0.0001 inch/rev
 (E command: corner chamfering/Corner R feed rate)
 Thread cutting
 F command 0.01 mm/rev, 0.0001 inch/rev
 E command 0.0001 mm/rev, 0.000001 inch/rev
 (E command: precise thread cutting lead)

(Note) Type 3 does not depend on the input unit.

Related parameter: "#1271 ext072bit2 (F-command unit)"

【#1266(PR)】 ext02

Not used. Set to "0".

【#1267(PR)】 ext03**bit0: G code type**

Select the high-speed high-accuracy G code type.

- 0: Conventional format (G61.1)
- 1: MITSUBISHI special format (G08P1)

【#1268(PR)】 ext04

bit0 : Compound type fixed cycle modal refresh

Select whether to refresh Group1 modal information by the G command issued at the end of a finished shape program.

- 0 : All the modal information are the same as immediately before G71, G72 or G73 command.
- 1 : Group1 modal information is refreshed by the G command issued at the end of a finished shape program. Other G code modals are the same as immediately before G71, G72 or G73 command.

bit1 : Finished shape start point

Select the start point of finished shape in the pocket machining.

- 0 : The top end point of the finished shape program is the start point of machining shape
- 1 : The cycle start point is the start point of machining shape

bit2 : Enable synchronous tapping per minute

Select whether to enable feed per minute with the F command of synchronous tapping cycle.

- 0 : Disable (Command in pitch regardless of "G group 5" modal)
- 1 : Enable (Follow "G group 5" modal)

bit3 : EOB independent blocks single stop

Select the operation of EOB independent block/a block only with comment in a single block mode.

- 0 : No single block stop
- 1 : Single block stop

bit4 : G76/G87 repetition count K enabled

Select whether to enable the repetition count K with G76/G87 command.

- 0 : Disable
- 1 : Enable

When this parameter is set to 1 while #1271 ext07/bit1(repetition count address specifying K) is set, the address K during G76/G87 command is the repetition count.

bit5 : Tool offset change amount compensation method (only for M system)

Select a compensation operation when the tool offset amount is changed during the tool offset compensation (G43/G44) by the tool length offset method per coordinates shift.

- 0 : Compensation operation with axis movement
- 1 : Compensation operation with coordinate shift

(Note) This parameter is enabled only when "#1268 ext04/bit6" is set to "1".

bit6 : Tool length compensation operation selection (for M system only)

Select the operation when the tool length compensation command is issued.

- 0 : Tool length compensation is executed by axis movement
- 1 : Tool length compensation is executed by coordinate shift.

【#1269(PR)】 ext05

bit0 : Command format for arc tangent ATAN

0 : Format 1: For the command value of "ATAN", the value of the ratio of two sides are to put in parentheses.

ATAN[#k] or ATAN[#j/#k]

1 : Format 2: For the command value of "ATAN", the value of the ratio of two sides are to put in parentheses and set apart with a diagonal.

ATAN[#j]/[#k]

bit1 : Calculation results range of arc tangent ATAN

Changeover the calculation results ranges of arc tangent ATAN with the command format 2 (#1269/bit0) of arc ATAN.

- 0 : -180° to 180°
- 1 : 0° to 360°

bit6 : Select workpiece coordinate to read

Select the coordinate to read on the workpiece coordinate (in #5041 and later).

- 0 : Workpiece coordinate
- 1 : Absolute coordinate

【#1270(PR)】 ext06**bit2: Select finished shape program search method**

Select how to search the finished shape program to be called by G70, G71, G72 or G73 command.

0: Standard specifications

Start the search from the head of the program designated by the currently executed program or an address A.

1: Extended specifications

<G71, G72, G73>

Start the search from the block following G71, G72 or G73 command.

<G70>

Start the search from the same start sequence No., if exists, as that of the finished shape program where G71, G72 or G73 command has been executed. Otherwise, start the search from the head of the program designated by the currently executed program or an address A.

bit3: Switch judgment of finished shape

Select whether to disable the judgment of finished shape at rough cutting command (G71 or G72).

When the finished shape's Z axis (or X axis at G72 command) does not move monotonously, a program error (or a shape change at pocket machining) will occur. This parameter is used to disable such a judgment of shape and execute the finished shape machining as commanded.

0: Enable

1: Disable

(Note 1) Although disabling the judgment of shape allows the expected finished shape machining, interference between tool and workpiece may happen depending on the machining shape, which may result in serious consequences. When disabling the judgment of shape, check the expecting finished shape carefully so that the interference will not occur.

(Note 2) Although the judgment of shape is disabled, a program error will occur when the machining quadrant is not determined.

(Note 3) Turning ON the G71 shape judgement invalid signal is also necessary to disable the judgment of finished shape.

bit4: Change chamfering operation

Select the operation in thread cutting cycle when a result of the chamfering cutting up exceeds the cycle start point.

0: As conventional specifications: program error occurs.

1: Extended specifications: program error does not occur.

The cutting up is stopped and the thread cutting block ends at the cycle start point. Then the axis moves to the end coordinate at rapid traverse feed.

bit5: Coordinate rotation angle without command (for L system only)

Select the operation when there is no rotation angle command R for the coordinate rotation.

0: Use the previously commanded value (modal value). If the command is the first issued command, the rotation angle will be 0°.

1: Use the set value in "#8081 Gcode Rotat".

bit6: Switch continuous thread cutting Z phase wait operation

Select when to start the 2nd block thread cutting when there is a command with no movement (MST command, etc.) between the thread cutting blocks.

0: Wait for the spindle's single rotation synchronization signal before starting the movement

1: Start movement without waiting for the spindle's single rotation synchronization signal

bit7: Handle C axis coordinate during cylindrical interpolation

Specify whether to keep the rotary axis coordinate as before the cylindrical interpolation start command is issued during the cylindrical interpolation.

0: Not keep the coordinate

1: Keep the coordinate

【#1271(PR)】 ext07

bit0: Mirror image operation

Select the type of mirror image operation.

0: Type 1

- The program mirror image, external mirror image, and parameter mirror image are exclusive to each other.
- An increment command moves the image to the position indicated by the travel amount with the sign inverted.

1: Type 2

- Mirror image operation is enabled when the program mirror image (G51.1) command is issued or when the external signal or parameter is ON.
- An increment command moves the image to the position determined by applying the mirror image to the absolute program coordinates.

bit1: Address specifying fixed cycle repetition count (for M system only)

Select the address that specifies the fixed cycle repetition count.

0: Address L only (Default)

1: Addresses K and L

If addresses K and L are specified simultaneously, the data at address K will be used for operation.

bit2: F-command unit

<M system>

Select the unit to be used when a thread cutting lead command does not contain decimal point.

*This unit does not depend on the input unit.

0: Type 1 (conventional specifications)

1mm/rev(command by mm), 1inch/rev(command by inch)

1: Type 2

0.01 mm/rev(command by mm), 0.0001 inch/rev(command by inch)

<L system>

Select the unit to be used when a lead command for synchronous feed and thread cutting does not contain decimal point.

0: Type 1 (conventional specifications)

When using input unit B ... 0.0001 mm/rev(command by mm), 0.000001 inch/rev(command by inch)

When using input unit C ... 0.00001 mm/rev(command by mm), 0.0000001 inch/rev(command by inch)

1: Type 2

0.0001mm/rev(command by mm), 0.000001inch/rev(command by inch)

(Note) For type 2, the unit to be used does not depend on the input unit.

[Related parameter] #1265 ext01(bit3) F-command unit 2

bit3: G-code group for unidirectional positioning (for M system only)

Select the G-code group for unidirectional positioning.

0: Unmodal G code (group 00)

1: Modal G code (group 01)

Related parameter: "#8209 G60 Shift" (Set the last positioning direction and distance for each axis applicable when the unidirectional positioning command is issued.)

bit4: Operation by independent G40 command

Select whether the radius compensation vector is canceled by the independent G40 command.

0: Type 1 (conventional specification) (Default)

The radius compensation vector will be canceled by the independent G40 command.

1: Type 2

The radius compensation vector won't be canceled by the independent G40 command: it will be canceled by the next travel command for the radius compensation plane.

bit5: Cut start position (for L system only)

Select the position from where cutting begins in a fixed cycle for compound lathe.

0: Conventional specification (Default)

The cut start position will be determined by the final shaping program.

1: Extended specification

The cut start position will be determined from the cycle start point.

bit6: Nose R compensation (for L system only)

Select whether to apply nose R compensation for shapes in a rough cutting cycle.

0: Conventional specification (Default)

The shape after nose R compensation in the final shaping program will be used as rough cutting shape (when the nose R compensation for the final shaping program).

1: Extended specifications

The shape without nose R compensation in the final shaping program will be used as rough cutting shape.

bit7: Cut amount (for L system only)

Select the operation to be performed when the program-specified cut amount exceeds the cut amount of the final shaping program.

0: Conventional specification (Default)

A program error will occur when the program-specified cut amount exceeds the cut amount of the final shaping program.

1: Extended specification

Rough cutting will be performed by one cut when the program-specified cut amount exceeds the cut amount of the final shaping program.

【#1272(PR)】 ext08

bit0: Switch pocket machining operation

Select the pocket machining specification.

0: Conventional specification

Pocket machining will be selected with the H designation.

The pull direction when pocket machining is ON will be the Z direction.

1: Extended specification

Pocket machining will start only when both X and Z axes are specified in the first travel block after the finished shape start block.

The pull direction when pocket machining is ON will be the X direction.

bit1: M function synchronous tap cycle

Specify whether to enable the M function synchronous tapping cycle.

0: Disable

1: Enable

bit2: Spiral/conical interpolation command format 2

Select the command format for spiral and conical interpolation.

0: Type 1 (conventional specification)

1: Type 2 (with the number of spiral rotation L designation and the increment designation)

bit3: Switch macro call function

Select whether to shift the argument to the subprogram if nests are overlapped when per block call (G66.1) is commanded.

0: Shift

1: Not shift (Conventional specification)

bit4: Tap cycle selection

Select the tapping cycle.

0: Pecking tapping cycle

1: Deep hole tapping cycle

bit5: Deep hole tap cycle override selection

Select whether to enable override on the pulling operation during synchronized tapping with the deep hole tapping cycle.

0: Disable

1: Enable

bit6: Switch corner chamfering/ corner R command format

Select the command format of the corner chamfering/corner R.

0: Command format I (conventional format)

Issue a command with comma (,C and ,R).

1: Command format II

In addition to command format I, addresses without comma can be used to command.

I/K or C can be used for corner chamfering, while R can be used for corner R.

bit7: Return position after macro interrupt in fixed cycle selection

Select the destination to return to after a macro interrupt in the fixed cycle.

0: Return to the block in the fixed cycle.

1: Return to the block next to the fixed cycle.

【#1273(PR)】 ext09**bit0: Switch ASIN calculation results range**

- Select the notation system for operation result of ASIN.
- 0: Do not switch minus figures to positive figures. (-90° to 90°)
 - 1: Switch minus figures to positive figures. (270° to 90°)

bit1: Switch system variable unit

- Select the unit for the system variable #3002 (time during automatic start).
- 0: 1ms unit
 - 1: 1 hour unit

bit2: Switch G71, G72, G73 cutting direction judgment

- Select the cutting direction when the longitudinal rough cutting cycle (G71), face rough cutting cycle (G72) or closed loop cutting cycle (G73) is commanded.
- 0: Conventional specifications
Determined according to the finished shape program.
 - 1: Extended specification
Determined according to the finishing allowance and cutting allowance commanded in the program.

bit3: Facing turret mirror image coordinate value type

- Select how to show the workpiece coordinate values of the axis for which the facing turret mirror image is valid.
- 0: Movements in the workpiece coordinate system are in the same direction as those in the workpiece machine coordinate system.
 - 1: Movements in the workpiece coordinate system are in the opposite direction to those in the workpiece machine coordinate system.

bit4: Facing turret mirror image valid axis selection

- Select the axis for which the facing turret mirror image is valid.
- 0: Fixed to 1st axis
 - 1: Determined according to the plane selected when the facing turret mirror image is commanded

bit5: Switch T command readout

- Select the value used to readout the T command modal information (#4120).
- 0: Tool No. only
 - 1: Tool No. and tool wear compensation No. (T command)

bit6: Retaining sequence No. (For special display unit)

- Select whether to retain sequence No. when jumping to a subprogram, resetting or turning the power OFF.
- 0: Not retain
 - 1: Retain

【#1274(PR)】 ext10

bit0: Decimal point command valid address

Select the designation of the addresses which enable decimal point commands.

0: Follows the standard specifications

1: Whether to enable or not depends on each address (not on the function)

<L system>

Valid address: X, Y, Z, U, V, W, A, B, C, E, F, G, H, I, J, K, R

Invalid address: D, L, M, N, O, P, Q, S, T

<M system>

Valid address: X, Y, Z, U, V, W, A, B, C, F, G, I, J, K, Q, R

Invalid address: D, E, H, L, M, N, O, P, S, T

bit1: Hole drilling fixed cycle Enable signed address R command (for L system only)

Select whether to enable the signed address R command in hole drilling fixed cycle.

0: Disable

The movement to the R point always follows the hole drilling direction.

1: Enable

The movement to the R point always follows the sign direction, ignoring the hole drilling direction.

bit2: M98 sequence number address selection

Select the addresses to call sequence number in subprogram with subprogram control (M98/M198).

0: Specify the sequence number with H address (conventional specification)

1: Specify the sequence number with Q address

bit3: Tool length offset (M system)(H independent command selection)

Select a command format of offset number with the tool length offset(M system).

The readout of tool length offset number H with variable number is also switched.

0: Independent command of tool length compensation number H is disabled

The tool length compensation number H of variable number is red during G43/G44 modal and fixed at 0 in other conditions.

1: Independent command of tool length compensation number H is enabled

The tool length compensation number H of variable number can be red regardless of G43/G44 modal.

bit4: Optional block skip operation selection

Select the operations of optional block skip.

0: Whether to enable the optional block skip in the middle of a block follows the setting of "#1226 aux10/bit1".

1: Enable at the head and in the middle of a block.

However, a slash code included in the right-hand side of an operation expression or an operation expression in parentheses [] is treated as a division operator.

bit5: Extended workpiece coordinate system G54Pn command

Select whether to use G54Pn for the extended workpiece coordinate system selection.

0: G54Pn is not used as the extended workpiece coordinate system selection.

1: G54Pn is used as the extended workpiece coordinate system selection.

When this parameter is set to 1, G54Pn command is handled in the same way as G54.1Pn.

bit7: Word range check

Select whether to check that the operation expression of the word date in the program is enclosed in brackets ([]) when the machine program is executed.

This check is also applied to the 08000 to 09999 and the machine tool builder macro program.

0: Disable

1: Enable

【#1275(PR)】 ext11

Not used. Set to "0".

【#1276(PR)】 ext12

Not used. Set to "0".

【#1277(PR)】 ext13**bit0: Tool life management II count type 2**

Select how and when the mount or use count will be incremented in tool life management II. The condition to output "tool group life over (TGLO)" signal will be changed accordingly.

0: Type 1 (Default)

Counts up when the spindle tool is used for cutting.

TGLO signal will be output when the last tool in selected group is judged as expired.

1: Type 2

Counts up by one for a tool used or mounted in a program at the time of resetting.

TGLO signal will be output when any of tool groups has reached its lifetime limit.

bit1: Tool life management II life prediction

Select whether to enable tool life prediction function in tool life management II.

0: Disable

1: Enable

bit2: Tool life management II life end signal timing

Select the timing at which tool life prediction signal is output in tool life management II.

0: Output only when the ["life value" - "used value"] matches the remaining life.

("life value" - "used value" = "remaining life")

1: Output when the ["life value" - "used value"] is less than the remaining life.

("life value" - "used value" \leq "remaining life")

bit3: Tool life management II life end signal tool

Select the tool for which the tool life prediction signal is output in tool life management II.

0: Output the signal tool by tool.

1: Output the signal at the last tool in the group.

bit4: Tool life management II count changeover (For M system only)

Select the tool life count method and its timing.

0: Conforms to "ext13/bit0" setting.

1: When "ext13/bit0" is set to "0":

Counts up by one for a tool used or mounted in a program at the time of resetting.

When "ext13/bit0" is set to "1":

Follow the setting of "Method (Mthd)" on Tool life screen.

The output condition of "tool group life over" signal conforms to "ext13/bit0".

【#1278(PR)】 ext14**bit0: Program restart method selection**

Select the program restart type.

0: Restart type A

1: Restart type B

【#1279(PR) ext15

bit0: Part system synchronization method

Select the part system synchronization method.

0: If one part system is not in the automatic operation, the synchronization command will be ignored and the next block will be executed.

1: Operate according to the "waiting ignore" signal.

If the "waiting ignore" signal is set to "1", the synchronization command will be ignored. When set to "0", synchronization will be applied.

bit1: Interrupt amount during machine lock

Select when to cancel the interruption amount during machine lock.

0: When resetting

1: During manual reference position return (not when resetting)

bit2: Selection of cutting start interlock target block

Select whether to enable the cutting start interlock for successive cutting blocks.

0: Enable

1: Disable

bit3: Retain asynchronous feed modal in cylindrical/ pole coordinate interpolation

Select whether to retain the asynchronous feed modal, which has been applied in the pole coordinate (cylindrical) interpolation, until the interpolation is canceled. (This parameter is enabled in G code systems 6 and 7 only.)

0: Not retain

1: Retain

bit4: Disable dry run in thread cutting

Select whether to disable dry run during thread cutting.

0: Enable (as default)

1: Disable

Note that when the spindle OFF mode signal is ON, dry run is enabled by the dry run signal regardless of this parameter setting.

bit5: G92 shift amount cancel

Select whether to clear the shift amount of coordinate system setting(G92) when arriving at the manual reference point.

0: Not clear

1: Clear

bit7: Manual R point return G52 maintain

Select whether to maintain the local coordinates system setting (G52) when arriving at the manual reference point.

0: Not maintain (cancel)

1: Maintain

This parameter is enabled only when "#1279 ext15/bit5" is "1".

【#1280(PR)】 ext16**bit0: I/F per axis during mixed control (cross axis control)**

Select how to handle the following PLC interface for axes interchanged with the mixed control (cross axis control).

- Mirror image
- Manual/automatic interlock
- Manual/automatic machine lock

0: Follows axis configuration before the mixed control (cross axis control).

1: Follows axis configuration after the mixed control (cross axis control).

(Example)

The device No. of automatic interlock (+) for X1 will be as follows when the mixed control (cross axis control) is executed with the 1st axis (X1) in the 1st part system and 1st axis (X2) in the 2nd part system.

When "0" is set: Y820 (interface for 1st axis in 1st part system)

When "1" is set: Y828 (interface for 1st axis in 2nd part system)

(Note) If the number of axes in the part system changes with the mixed control (cross axis control), the interface of the target axis may change when this parameter is set to "1".

(Example)

When 1st part system's C axis is moved to 2nd part system with a 1st part system (X, Z, C, Y) and 2nd part system (X, Z) configuration:

When "1" is set: Y82A, Y7CA, Y8AA and later will be the interface for the C axis moved to the 2nd part system. Y7C2, Y822, Y8A2 and later will be the interface of the Y axis in the 1st part system, because the axes following the removed C axis (third place) are shifted up.

bit1: Mixed control (cross axis control) cancel with reset

Select whether to cancel the mixed control (cross axis control) when reset is applied.

0: Cancel.

1: Not cancel.

bit2: Interchange coordinate position display

Select whether to display interchanged (or moved) coordinate positions in the mixed control (cross axis control).

This setting will be applied when the axes are moved, as well as when the axes are interchanged.

0: Display interchanged (or moved) coordinate positions.

1: Display coordinate positions without being interchanged (nor moved).

(Example)

When 1st part system's C axis is moved to 2nd part system with a 1st part system (X, Z, C, Y) and 2nd part system (X, Z) configuration:

1st part system: X, Z and Y coordinate positions are displayed.

2nd part system: X, Z and C coordinate positions are displayed.

bit3: Reset operation for synchronization/super-imposition control

Select whether to cancel synchronization/superimposition control when reset is applied.

0: Cancel.

1: Not cancel.

【#1281(PR)】 ext17

bit0: Switch manual high-speed reference position return in synchronous control

Select the movement of synchronized axes in manual high-speed reference position return.

- 0: Primary and secondary axes start the return synchronizing. Even when one axis stops at its reference position, the other axis continues moving until it reaches its reference position.
- 1: Primary and secondary axes start the return synchronizing, and when the primary axis stops at the reference position, the secondary also stops. Thus, the relative position of the primary and secondary is kept.

bit1: Tool offset addition axis selection

Select the axis for tool offset.

- 0: Follows "#1520 TchG34 (Additional axis tool compensation operation)".
- 1: Designate the axis in "#1027 base J (Base axis J)" as the 3rd axis compensation axis.

bit2: Reference point return position selection for inclined axis control

Select the reference point return position of the inclined axis control.

- 0: X axis(basic axis) returns to the reference point of the actual axis regardless of Y axis(inclined axis) position.
- 1: X axis(basic axis) returns to the hypothetical reference point on the program coordinates. Thus, the return position of the actual axis differs depending on Y axis(inclined axis) position. When X axis returns to the hypothetical reference point on the program coordinate, the selection for the compensation at reference position return (#1192s_zrmv) is disabled and the compensation is applied regardless of the setting.

bit3: Synchronous control operation setting

Select whether or not the positioning of secondary axis automatically aligns with that of primary axis when the axis subject to synchronous control is changed from servo OFF to servo ON.

- 0: The positioning automatically aligns.
- 1: The positioning does not align.

bit4: Handle feed clamp selection

Select the operation when the speed has been clamped by the clamp speed in handle feed mode.

- 0: Clamp the movement speed (compatible with conventional specifications)
- 1: Clamp the number of handle input pulses

bit5: High-speed synchronous tapping valid

Select whether to enable the high-speed synchronous tapping.

- 0: Disable
- 1: Enable

bit6 : Compensation method for external machine coordinate system/ball screw thermal expansion during synchronization

Select the method of how to compensate the secondary axis when compensating external machine coordinate system or ball screw thermal expansion during synchronization control. The setting of this parameter will be validated when you select synchronous operation method by the synchronization control operation method signal.

- 0: Primary axis and secondary axis are independently compensated.
- 1: Primary axis' compensation amount is applied to secondary axis.

bit7: Switch automatic high-speed reference position return in synchronous control

Select the movement of synchronized axes in automatic high-speed reference position return.

- 0: Primary and secondary axes start the return synchronizing, and when the primary axis stops at the reference position, the secondary also stops. Thus, the relative position of the primary and secondary is kept.
- 1: Primary and secondary axes start the return synchronizing. Even when one axis stops at its reference position, the other axis continues moving until it reaches its reference position.

【#1282(PR)】 ext18**bit0: Enable optimum acceleration/deceleration control**

Select the speed control to use between blocks when high-accuracy control is enabled.

- 0: Optimum corner deceleration
- 1: Optimum acceleration control

(Note) Set "1" to enable high-accuracy control in polar coordinate/ cylindrical interpolation.

bit1: Condition of the reference position reached signal in synchronous control

This parameter switches only conditions of a primary axis's reference position return reached signal in synchronous operation. A secondary axis's signal is output when the secondary axis reaches the reference position coordinate.

- 0: A primary axis's reference position reached signal is output only when both of the primary and secondary axes reach the reference position coordinate by a reference position return.
- 1: A primary axis's reference position reached signal is output when the primary axis reaches the reference position coordinate.

bit3: Index table clamp type selection

Select a clamp method of the index table.

- 0: Type A Clamp with OFF of unclamp command.
- 1: Type B Clamp with ON of clamp command.

bit5: Automatic correction of synchronization offset at power ON

The secondary axis position is automatically corrected so that the synchronization offset before having turned the power OFF the last time can be restored at power ON.

- 0: Disable
- 1: Enable

(Note) This parameter is enabled when "#1281 ext17/bit3 Synchronous control operation setting" is set to "1".

bit6: Reset at canceling emergency stop

Select a reset when the emergency stop is canceled.

- 0: Reset 1
- 1: Reset 2

【#1283(PR)】 ext19

Not used. Set to "0".

【#1284(PR)】 ext20**bit0: Spindle speed clamp check**

Select whether to check the spindle speed clamp under the constant surface speed control.

- 0: Check the spindle speed clamp.
- 1: Not check the spindle speed clamp.

(Note) This parameter is enabled when the parameter "#1146 Sclamp" is set to "1".

【#1285(PR)】 ext21

Not used. Set to "0".

【#1286(PR) ext22

bit0: Program input/output method selection

Select the program input/output method.
 0: Only the programs in the selected part system are input/output.
 1: The designated programs are output for all part systems.

bit2: O No. for program input No.

Select the operation when the same program No. is input during data input.
 0: The O No. is handled as a character string data.
 1: The O No. is handled as a program No. Whether to overwrite the program or cause an error is decided by "#1218 bit7 Input by program overwrite".

bit3: No O No. at machining program input

Select whether to enable the machining program input even if there is no program No. (O No.).
 The program No. is fixed to 01 in this case.
 0: Disable
 1: Enable

bit4: Enable deletion of comment following O No.

Select whether to enable deleting the comment section (including parenthesis) after O No., which has no comment statement, in outputting the machining program.
 0: Disable
 1: Enable
 When this parameter is set to "1", the comment section following O No. will not be output if it has no valid comment (character except space).
 <Example>
 0123(); -> 0123;
 0123(); -> 0123;
 0123(TEST) ; -> 0123(TEST);

【#1287(PR)】 ext23**bit0: Workpiece coordinate display**

Select how to display workpiece coordinate counter.

- 0: Not update the display immediately after workpiece coordinate data has been changed.
- 1: Update the display immediately after workpiece coordinate data has been changed.

bit1: Inclined surface coordinate display (tool length offset)(for M system only)

- 0: Display the position which includes tool length offset.
- 1: Display the position on the program which excludes tool length offset.

bit2: Inclined surface coordinate display (tool radius compensation)(for M system only)

- 0: Display the position which includes tool radius compensation.
- 1: Display the position on the program which excludes tool radius compensation.

bit3: Counter display expanded function selection

Select whether to enable the counter display expanded function (bit4 to bit7).

- 0: Disable (Display the command value excluding tool length offset amount and workpiece coordinate offset amount)
- 1: Enable

bit4: Relative coordinate display

(M system)

- 0: Display the position which includes tool length offset.
- 1: Display the position on the program which excludes tool length offset.

(L system)

- 0: Display the position which includes tool shape compensation.
- 1: Display the position on the program which excludes tool shape compensation.

bit5: Relative coordinate display

(M system)

- 0: Display the position which includes tool radius compensation.
- 1: Display the position on the program which excludes tool radius compensation.

(L system)

- 0: Display the position which includes nose R compensation.
- 1: Display the position on the program which excludes nose R compensation.

bit6: Absolute coordinate display (For special display unit)

(M system)

- 0: Display the position which includes tool length offset.
- 1: Display the position on the program which excludes tool length offset.

(L system)

- 0: Display the position which includes tool shape compensation.
- 1: Display the position on the program which excludes tool shape compensation.

bit7: Absolute coordinate display (For special display unit)

(M system)

- 0: Display the position which includes tool radius compensation.
- 1: Display the position on the program which excludes tool radius compensation.

(L system)

- 0: Display the position which includes nose R compensation.
- 1: Display the position on the program which excludes nose R compensation.

(Note) In L system, the machining position in program command is displayed in the absolute coordinate counter by setting "1" in this parameter or in "#1227 aux11/bit 3 (Absolute coordinate changeover (nose R))".

【#1288(PR)】 ext24**bit0: MDI program clear**

Select whether to clear the MDI programs when MDI operation ends, the power is turned ON again, reset is input, or emergency stop is canceled.

- 0: Not clear.
- 1: Clear (save only % programs).

【#1289(PR)】 ext25**bit0: Tool radius compensation switch corner judgment method (Nose R comp.)**

Select the criterion to execute the outer rounding at the small corner in tool radius compensation.
(L system)

0: The corner angle is 0°; linear-linear; G02-G03/G03-G02; the radius is the same. (Conventional method)

1: The corner angle is 1° or smaller; linear-linear; G02-G03/G03-G02; the radius is almost the same. (Method for rounding minute corner angle)

(M system)

0: The corner angle is 1° or smaller; linear-linear; G02-G03/G03-G02. (Conventional method)

1: The corner angle is 1° or smaller; linear-linear; G02-G03/G03-G02; the radius is almost the same. (Method for rounding minute corner angle)

bit1: 3-dimensional tool radius compensation selection

Select an operation for 3-dimensional tool radius compensation during the program coordinate rotation.

0: Rotate the coordinates after the 3-dimensional tool radius compensation.

1: Rotate the coordinates before the 3-dimensional tool radius compensation.

【#1290(PR)】 ext26

Not used. Set to "0".

【#1291(PR)】 ext27**bit0: Skip coordinate readout selection**

Select the coordinate data to read out for skip coordinate (#5061 and later)

0: Workpiece coordinate

1: Absolute coordinate

bit1: System variable (#5081) selection (only for M system)

0: Amount of tool position offset

1: Amount of tool length offset

【#1292(PR)】 ext28**bit0: Subprogram name at M198 command**

- Set a name of subprogram which is called with the execution of M198 command.
- 0: The subprogram with the program name "extension(.PRG) addition" is to be called.
 - 1: The subprogram with the program name "head number O" is to be called.

bit1: Synchronous tapping F command selection (only for M system)

- Switch the specifications about the address F of the synchronous tapping cycle.
- 0: The value of the address F commanded with the synchronous tapping cycle is the feed speed. The F command follows the setting of "#1268 ext04/bit2 Enable synchronous tapping per minute".
 - 1: Follows G group 5 modal regardless of the setting for "#1268 ext04/bit2 Enable synchronous tapping per minute". The value of F modal commanded in program is the feed speed. Related parameter: "#1268 ext04/bit2 Enable synchronous tapping per minute"

bit2: Target axis selection for rotary axis workpiece position compensation

- Select the target axis for the workpiece position compensation of the rotary axis.
- 0: For compensation plane horizontal axis and compensation plane vertical axis
 - 1: All liner axes
 - * The axes for which rotary axis workpiece position compensation is disabled ("#2100 rpcax" is 0) are not to be compensated regardless of the setting of this parameter.

bit3: Tool length offset change amount compensation selection (only for M system)

- Select an compensation operation when returning from G53,G28, G30, G30.1 tool length offset amount temporary cancel and when tool length offset amount is changed during the the tool length offset compensation(G43/G44).
- 0: Start to compensate from the movement command to the axis targeted for compensation.
 - 1: Start to compensate from the next block.

bit4: Hobbing workpiece axis selection

- Set the selection method for a workpiece axis number for the hobbing command "MITSUBISHI CNC special format (G81.4)".
- 0: Select with the parameter (#1596 hobs).
 - 1: Select with the selection signal of hobbing workpiece axis.

bit5: Subprogram call selection in fixed cycle mode

- Switch the operation when the subprogram call(M98/M198) command and the axis address or the address R(when hole drilling cycle) are commanded in the same block during the hole drilling fixed cycle or the lathe fixed cycle.
- 0: Fixed cycle is not operated. Thus, hole bottom position of fixed cycle by the position commanded with axis address is not memorized. Move with the modal of 01 group to the commanded position of axis address. Then, call the subprogram.
 - 1: The fixed cycle is performed as the argument of the fixed cycle. Then, call the subprogram.

bit6: Spindle-spindle polygon machining workpiece axis selection

- Set the selection method when the address command H is skipped for workpiece axis selection under the spindle-spindle polygon machining command(G51.2).
- 0: Select with the parameter (#1518 polm).
 - 1: Select with the spindle-spindle polygon machining workpiece.

【#1293(PR)】 ext29

Not used. Set to "0".

【#1294(PR)】 ext30

Not used. Set to "0".

【#1295(PR)】 ext31

Not used. Set to "0".

【#1296(PR)】 ext32

Not used. Set to "0".

【#1297(PR)】 ext33

Not used. Set to "0".

【#1297(PR)】 ext33

Not used. Set to "0".

【#1298(PR)】 ext34

bit0: G53 command in nose R (radius) compensation

Select whether to issue an alarm (program error) for the G53 commanded in nose R (radius) compensation.

- 0: Issue an alarm
- 1: Not issue an alarm

【#1299(PR)】 ext35

bit0: Selection of the specification of manual skip

Select the specification of manual skip. Set to "1".

- 0: Standard
- 1: Specific

bit1: Manual skip acceleration/deceleration mode

Select a acceleration/deceleration pattern when the manual skip is enable.

- 0: The time constant of selected manual drive mode and acceleration/deceleration pattern are selected. Turn ON the control number 1(R2684/BIT2) for specified users to switch to the acceleration/deceleration pattern step(time constant 1).
- 1: The acceleration/deceleration pattern of the step(time constant 1)
* Enabled when #1299/BIT0 is 1(specification for specified users)

bit2: Initial automatic tool nose R mode

Select whether to enable the automatic tool nose R compensation at the power ON.

- 0: Not enable the mode until commanded
- 1: Enable the mode at the power ON (initial command G143)

【#1300(PR)】 ext36

bit0: Multiple spindle control II

Select multiple spindle control I or II.

- 0: Multiple spindle control I (L system only)
- 1: Multiple spindle control II (select from ladder)

bit1 : Spindle control for each part system

Select whether to set spindle control command (S code/G96/G92) to be common in the part systems or to be separated by each part system when multiple spindle control II is enabled ("#1300 ext36/bit0" is set to "1").

- 0: Common in the part systems
- 1: Separated by each part system

bit7: Spindle synchronization command method

Select the spindle synchronization command method.

- 0: Spindle synchronization with PLC I/F
- 1: Spindle synchronization with machining program

【#1301】 nrfchk Near reference position check method

Select the method to judge the "near reference position".

- 0: Conventional method
- 1: Command machine position is used.
- 2: Feedback position is used.

【#1302】 AutoRP Automatic return by program restart

Select the method to move to the restart position when restarting the program.

- 0: Move the system manually to the restart position and then restart the program.
- 1: The system automatically moves to the restart position at the first activation after the program restarts.

【#1303(PR)】 V1comN No. of #100 address part system common variables

Set the number of common variables, common for part systems, starting from address #100.
This is valid only when "#1052 MemVal" is set to "1".

---Setting range---
0 to 100

【#1304(PR)】 V0comN No. of #500 address part system common variables

Set the number of common variables, common for part systems, starting from address #500.
This is valid only when "#1052 MemVal" is set to "1".

---Setting range---
0 to 500

【#1306】 InpsTyp Deceleration check specification type

Select the parameter specification type for the G0 or G1 deceleration check.
0: Deceleration check specification type 1
G0 is specified with "#1193 inpos", and G1+G9 with "#1223 aux07/bit1".
1: Deceleration check specification type 2
G0 or G1+G9 is specified with "#1193 inpos".

【#1307(PR)】 G0acc_plc PLC axis G00 constant inclination valid

Set a type of acceleration/deceleration for the rapid traverse command.
0: Time constant acceleration/deceleration (conventional method)
1: Constant inclination acceleration/deceleration

【#1308(PR)】 G1acc_plc PLC axis G01 constant inclination valid

Select the type of acceleration/deceleration for the cutting feed command.
0: Time constant acceleration/deceleration (conventional method)
1: Constant inclination acceleration/deceleration

【#1309(PR)】 GType Switch command format

Select which is used to command the reverse tap.
0: G84.1/G88.1
1: D command with the value changed to negative

【#1310】 WtMmin Minimum value for synchronization M code

Set the minimum value for the M code. When "0" is set, the synchronization M code will be invalid.

---Setting range---
0, 100 to 99999999

【#1311】 WtMmax Maximum value for synchronization M code

Set the maximum value for the M code. When "0" is set, the synchronization M code will be invalid.

---Setting range---
0, 100 to 99999999

【#1312】 T_base Tool life management standard number

Set the standard No. for the tool life management.
When the value specified by the T code command exceeds the set value in this parameter, the set value will be subtracted from the command value, which will be used as tool group No. for tool life management.
When the value specified by the T code command is equal to or less than the set value, the T code will be handled as a normal T code and not subjected to tool life management.
When "0" is set in this parameter, the T code command will always specify a group No. (Valid for M-system tool life management II.)

---Setting range---
0 to 9999

【#1313】 TapDw1 Synchronous tap hole bottom wait time

Set the hole bottom wait time for synchronous tapping.

When P address is specified, the greater value will be used as the hole bottom wait time. When an in-position check is performed at the hole bottom, the wait time will be provided after the completion of the in-position check.

(Note) This parameter is valid only when "1" is set in "#1223 aux07/bit3" (synchronous tap in-position check improvement) and "#1223 aux07/bit4" (synchronous tap hole bottom in-position check).

---Setting range---

0 to 999 (ms)

【#1314】 TapInp Synchronous tap in-position check width (tap axis)

Set the hole bottom in-position check width for synchronous tapping.

(Note) This parameter is valid only when "1" is set in "#1223 aux07/bit3" (synchronous tap in-position check improvement) and "#1223 aux07/bit4" (synchronous tap hole bottom in-position check).

---Setting range---

0.000 to 99.999

【#1315】 RcmpBlk Tool radius compen. max. number of pre-read blocks (Nose R compen.)

Set the maximum number of pre-read blocks for tool radius compensation.

When "0" is set, maximum number of pre-read blocks will be 4. (as conventional specifications)

---Setting range---

0 to 4

【#1318(PR)】 MacVcom Machine tool builder macro variable for each part system

Select how to use machine tool builder macro variables(#80000 - #80049, #80500 - #80649, #459 - #499), whether shared by all part systems or used independently by the part systems.

0: #450 - #499/#80000 - #80049/#80500 - #80649 are shared by all part systems.

1: #450 - #499 are shared by all part systems, #80000 - #80049/#80500 - #80649 are used independently by the part systems.

2: #450 - #499 are used independently by the part systems, #80000 - #80049/#80500 - #80649 are shared by all part systems.

3: #450 - #499/#80000 - #80049/#80500 - #80649 are used independently by the part systems.

【#1323(PR)】 chopsel Chopping command method selection

Select the method for the chopping command.

0: Command from the ladder

1: G command(G81.1)

【#1324(PR)】 Chop_R

Not used. Set to "0".

【#1326】 PLC Const Ext. Num PLC constant extension number

Set the number of PLC constant extension points.

---Setting range---

0 to 750

【#1328】 TLM type Tool measurement standard positions election

Select the tool measurement method.

0: Use the machine position at TLM switch ON as 0.

1: Use the machine basic point as standard.

【#1329】 Emgcnt Emergency stop contactor shut-off time

Set the time taken for the drive section's main power to be shut-off when the confirmation of all the axes' stop failed after the emergency stop state.

The contactor shut-off signal is output as soon as all the axes are confirmed stopped if the confirmation is done prior to the set time.

When there is no safety observation option or "0" is set, the shut-off time will be 30(s).

---Setting range---

0 to 60 (s)

【#1330(PR)】 MC_dp1 Contactor weld detection device 1

When safety observation is executed, set the remote I/O device to input the contactor's auxiliary b contact signal used for the contactor weld detection.

If "0" is set, weld detection will not be executed.

---Setting range---

0000 to 02FF (HEX)

【#1331(PR)】 MC_dp2 Contactor weld detection device 2

When safety observation is executed, set the remote I/O device to input the contactor's auxiliary b contact signal used for the contactor weld detection.

If "0" is set, weld detection will not be executed.

---Setting range---

0000 to 02FF (HEX)

【#1333】 LMC restrain Lost motion compensation restraint in handle mode

Select whether to restrain the lost motion compensation in handle mode.

0: Restrain

1: Not restrain

【#1335】 man_smg Manual feed acceleration/deceleration selection

Select the acceleration/deceleration mode in jog feed, incremental feed and manual reference position return (when rapid traverse signal OFF).

0: Acceleration/Deceleration for rapid traverse

1: Acceleration/Deceleration for cutting feed

【#1338(PR)】 rev data save trg Trigger switching to save arbitrary reverse run data

Select the condition to start/stop saving reverse run data.

0: Start when the reverse run control mode signal is turned ON. Stop when turned OFF.

1: Start when the reverse run control mode signal is ON and macro interrupt is valid (M96/ION).

Stop when the reverse run control mode signal is OFF or macro interruption is finished (M97/IOF) (compatible with M500M).

【#1339(PR)】 MC_dp3

Not used. Set to "0000".

【#1340(PR)】 MC_dp4

Not used. Set to "0000".

【#1342】 AlmDly Alarm display delay time

Set a time between when an operation alarm occurs and when the alarm display and signal turn ON. When set to "0", the alarm display and signal will turn ON immediately after the alarm occurrence.

When set to "-1", the alarm display and signal will not turn ON after the alarm occurrence.

Target alarms:

M01 External interlock axis found 0004

M01 Internal interlock axis found 0005

M01 Sensor signal illegal ON 0019

M01 No operation mode 0101

---Setting range---

-1 to 30000 (ms)

【#1349(PR)】 DOOR_1 Door 1 switch input device

Set a remote I/O device to input the door sensor signal to detect Door 1's status in safety observation.

When "0" is set, the door is always detected to be open.

Thus, "X0" cannot be used as Door 1 switch input device.

---Setting range---

0000 to 02FF (HEX)

【#1350(PR)】 DOOR_2 Door 2 switch input device

Set a remote I/O device to input the door sensor signal to detect Door 2's status in safety observation.

When "0" is set, the door is always detected to be open.

Thus, "X0" cannot be used as Door 2 switch input device.

---Setting range---

0000 to 02FF (HEX)

【#1351(PR)】 DOOR_3 Door 3 switch input device

Set a remote I/O device to input the door sensor signal to detect Door 3's status in safety observation.

When "0" is set, the door is always detected to be open.

Thus, "X0" cannot be used as Door 3 switch input device.

---Setting range---

0000 to 02FF (HEX)

【#1352(PR)】 DOOR_4 Door 4 switch input device

Set a remote I/O device to input the door sensor signal to detect Door 4's status in safety observation.

When "0" is set, the door is always detected to be open.

Thus, "X0" cannot be used as Door 4 switch input device.

---Setting range---

0000 to 02FF (HEX)

【#1353(PR)】 MC_ct1 Contactor shutoff output 1 device

Set a device of an output remote I/O device to control contactor in safety observation.

When set to "0", contactor shutoff output is disabled.

Thus, "Y0" cannot be used as contactor shutoff output device.

---Setting range---

0000 to 02FF (HEX)

【#1357(PR)】 mchkt1 Contactor operation check allowed time 1

Set a period of time until emergency stop is issued when a contactor does not operate even though contactor shutoff output 1 is output.

If the vertical axis drop prevention function is used, set a value bigger than the vertical axis drop prevention time (SV048 EMGrT).

When "0" is set, the contactor operation check will be disabled.

---Setting range---

0 to 30000 (ms)

【#1361(PR)】 aux_acc Auxiliary axis acceleration/deceleration type

Select the acceleration/deceleration type of auxiliary axis in PLC axis indexing.

0: Acceleration/deceleration with constant time

1: Acceleration/deceleration with a constant angle of inclination

【#1364】 thro2

Not used. Set to "0".

[#1365] manualFtype Manual speed command type

Select the manual speed command type.

0: Manual speed command

The axis travels at the handle/jog feed rate.

Reverse run is performed for each part system independently of the other ones.

1: Manual speed command 2

In a multi-part system configuration, the axis travels at the handle/jog feed rate multiplied by the ratio of each part system's program command speeds.

When the block start point is reached in reverse run in any of the part systems, the axes in the other part systems stop simultaneously.

 [#1366] skipExTyp Multi-system simultaneous skip command

Select the operation when G31 is commanded in more than one part system.

(Note) When set to "1", the skip coordinate position will always be "0" whether G31 is commanded in a single part system or in one part system of a multi-part system.

Set to "0" when using G31 command for measurement etc.

0: Carry out G31 command in one part system, while the G31 is kept in an interlocked state in the other systems.

1: Carry out G31 command simultaneously in more than one part system.

Note that the skip coordinate is not read and so the skip coordinate value will be 0.

 [#1367] G1AccOVRMax Max. override value for cutting feed constant inclination acc./dec.

Set the maximum override value to be applied to the cutting feed that is in constant inclination acceleration/deceleration.

When the setting of this parameter is between 0 and 99, the override value is handled as 100% even though the specified cutting feed override is over 100%.

---Setting range---

0 to 300(%)

 [#1369(PR)] S_Sig1 Safety observation signal device 1

Set the remote I/O device to input the safety observation signal 1 during executing the safety observation function.

When set to "0", there is no safety observation signal input.

Therefore "X0" cannot be used as safety observation signal device.

---Setting range---

0000 to 02FF (HEX)

 [#1370(PR)] S_Sig2 Safety observation signal device 2

Set the remote I/O device to input the safety observation signal 2 during executing the safety observation function.

When set to "0", there is no safety observation signal input.

Therefore "X0" cannot be used as safety observation signal device.

---Setting range---

0000 to 02FF (HEX)

 [#1373(PR)] mstpssc Multi-step speed monitor enabled

Select whether to enable the multi-step speed monitor.

0: Disable

1: Enable

(Note) When enabling the multi-step speed monitor, setting values for SV238, SV239, SP238, SP239 will be ignored.

 [#1379(PR)] S_Sig3 Safety observation signal device 3

Set the remote I/O device to input the safety observation signal 3 during executing the safety observation function.

When set to "0", there is no safety observation signal input.

Therefore "X0" cannot be used as safety observation signal device.

---Setting range---

0000 to 02FF (HEX)

【#1380(PR)】 TolOfsVal_M Changeover of tool offset variable number (only for M system)

Changeover the variable number of tool compensation(M system).

0: type 1 (MITSUBISHI standard specification)

Length dimension: #10001-, #2001-

Length wear: #11001-, #2201-

Radius dimension: #16001-, #2401-

Radius wear: #17001-, #2601-

1: type 2

Length dimension: #11001-, #2201-

Length wear: #10001-, #2001-

Radius dimension: #13001-

Radius wear: #12001-

2: type3

Length dimension: #10001-, #2001-

Length wear: #11001-, #2201-

Radius dimension: #12001-, #2401-

Radius wear: #13001-, #2601-

3: type4

Length dimension: #10001-, #2001-

Length wear: #11001-, #2201-

Radius dimension: #12001-

Radius wear: #13001-

【#1381(PR)】 TolOfsCmdCheck_M Tool off set command check (only for M system)

bit0: Compensation number zero check enable

Designate a check type for the compensation number in a compensation command(note).

0: Compensation number zero check Disable

1: Compensation number zero check Enable

(Note) Compensation commands are as follows.

Tool radius compensation (G41,G42,G41.2,G42.2) D command

Tool length compensation (G43,G44,G43.1,G43.4,G43.5) H command

Tool position compensation (G45,G46,G47,G48) D command

bit1: Compensation amount zero check enable

Designate a check type for the compensation amount in a compensation command(note).

0: Compensation amount zero check Disable

1: Compensation amount zero check Enable

(Note) Compensation commands are as follows.

Tool radius compensation (G41,G42,G41.2,G42.2) D command

Tool length compensation (G43,G44,G43.1,G43.4,G43.5) H command

Tool position compensation (G45,G46,G47,G48) D command

【#1382】 retract_axis_chk Operation changeover with the axis unintended for retract and return

bit0: Select an operation with G10.6 command to the axis unintended for the tool retract and return 2

Select an operation with G10.6 command to the axis unintended for the tool retract and return 2

0: No alarm and no operation of the retract and return to the axis unintended for the retract and return.

1: Alarm stop.

(Note) This parameter is not enabled for the tool retract and return command. If the tool retract and return is commanded to an axis unintended for the tool retract and return, this parameter takes its operation of "0", ignoring the set value of this parameter.

【#1493(PR)】 ref_syn Synchronization at zero point initialization

0: Primary axis and second axis determine their zero points individually.

1: The zero points of both primary and secondary axes are determined by initializing the primary axis' zero point.

The secondary axis moves in perfect synchronization with the primary axis.
Set this to "1" for speed/current command synchronization control.

【#1501】 polyax Rotational tool axis number (for L system only)

Set the number of the rotational tool axis used for polygon machining (G51.2). Set "0" when not using polygon machining (spindle-servo axis), or when using spindle-spindle polygon machining. A value exceeding the base specification parameter "#1002 axisno" cannot be specified. This parameter is valid when the G code system is 6 or 7 (7 or 8 is set in base specification parameter "#1037 cmdtyp").

【#1502】 G0lpfg G1 -> G0 deceleration check

Select whether to perform a deceleration check when the travel direction is changed from G1 to G0.
0: Not perform
1: Perform

【#1503】 G1lpfg G1 -> G1 deceleration check

Select whether to perform a deceleration check when the travel direction is changed from G1 to G1.
0: Not perform
1: Perform

【#1505】 ckref2 Second reference position return check

Select whether the check is carried out at the specified position in manual second reference position return mode upon completion of spindle orientation or at second reference position return interlock signal.
0: Upon completion of spindle orientation
1: At second reference position return interlock signal

【#1506】 F1_FM Upper limit of F1-digit feedrate

Set the maximum value up to which the F 1-digit feedrate can be changed.

---Setting range---
0 to 60000 (mm/min)

【#1507】 F1_K F 1-digit feedrate change constant

Set the constant that determines the speed change rate per manual handle graduation in F 1-digit feedrate change mode.

---Setting range---
0 to 32767

【#1508】 TLM_Fmin Minimum speed toward tool setter

Set the minimum speed toward the tool setter.
The sensor's ON at the lower speed than this set value regarded as an illegal input, which displays an error.
Default value (when "0" is set) is 4.0mm/min.

---Setting range---
0.0 to 9999.9 (mm/min)

【#1509】 TLM_Fmax Maximum speed toward tool setter

Set the maximum speed toward the tool setter.
The sensor's ON at the higher speed than this set value regarded as an illegal input, which displays an error.
Default value (when "0" is set) is 1,000.0 mm/min.

---Setting range---
0.0 to 9999.9 (mm/min)

【#1510】 DOOR_H Shorten door interlock II axis stop time

Select whether to shorten the time during which the axis is stopped when the door is opened.
0 : Use the conventional axis stop time.
1 : Shorten the axis stop time.

(Note) When the door interlock II signal is input via a ladder, the conventional axis stop time will be used.

【#1511】 DOORPm Signal input device 1 for door interlock II: for each part system

Set the fixed device number (X??) for door interlock II signal input for each part system.
 A device number from X01 to XFF can be specified.
 Device number "000" is invalid.
 Set device number "100" when using no fixed device number for door interlock II signal input.
 Related parameter: "#1154 pdoor (Door interlock II for each part system) "

---Setting range---

000 to 2FF (hexadecimal)

【#1512】 DOORPs Signal input device 2 for door interlock II: for each part system

Set the fixed device number (X??) for door interlock II signal input for each part system.
 (Set the same value as that of #1155.)
 Related parameter: "#1154 pdoor (Door interlock II for each part system)"

---Setting range---

000 to 2FF (hexadecimal)

【#1513】 stapM M code for synchronous tap selection

Set the M code for the synchronous tapping selection.
 Select the synchronous tapping mode using the miscellaneous function code of the value set in this parameter. The M function command can be issued immediately before the tap command or in the same block. This function is valid only when "1" is set in "#1272 ext08/bit1 (Enable/disable M-function synchronous tap cycle)".
 (Note) Do not use M00, 01 02, 30, 98, and 99.

---Setting range---

0 to 99999999

【#1514】 expLinax Exponential function interpolation linear axis

Set the axis name for the linear axis used in exponential function interpolation.

---Setting range---

A to Z

【#1515】 expRotax Exponential function interpolation rotary axis

Set the axis name for the rotary axis used in exponential function interpolation.

---Setting range---

A to Z

【#1516】 mill_ax Milling axis name

Set the name of the rotary axis used in milling interpolation. Only one rotary axis can be set.
 When there is no E command in issuing the G12.1 command, this parameter will be followed.

---Setting range---

A to Z

【#1517】 mill_C Milling interpolation hypothetical axis name

Select the hypothetical axis command name for milling interpolation.
 When there is no D command in issuing the milling interpolation command, this parameter will be followed.
 0: Y axis command
 1: Command rotary axis name.

【#1518】 polm Spindle-spindle polygon Workpiece spindle No.

Set the workpiece axis No. used in spindle-spindle polygon machining.
 (Note) The 1st spindle will be selected when "0" is set.

【#1519】 pols Spindle-spindle polygon Tool spindle No.

Set the number of the rotary tool spindle used in spindle-spindle polygon machining.
 (Note) The 2nd spindle will be selected when "0" is set.

【#1520(PR)】 Tchg34 Additional axis tool compensation operation (for L system only)

Select axis to carry out the additional axis' tool compensation function.
 0: 3rd axis.
 1: 4th axis.

【#1521】 C_min Minimum turning angle

Set the minimum turning angle of the normal line control axis at the block joint during normal line control.

---Setting range---
 0.000 to 360.000 (°) (Input setting increment applies)

【#1522(PR)】 C_axis Normal line control axis

Set the number of the axis for normal line control.
 Set a rotary axis No.
 0: Normal line control disabled
 1 to 8: Axis No. (number of control axes)

【#1523】 C_feed Normal line control axis turning speed

Set the turning speed of the normal line control axis at the block joint during normal line control.
 Set a value that does not exceed the normal line control axis' clamp speed ("#2002 clamp").
 This is valid with normal line control type I.

---Setting range---
 0 to 1000000 (°/min)

【#1524】 C_type Normal line control type

Select the normal line control type.
 0: Normal line control type I
 1: Normal line control type II

【#1533】 millPax Pole coordinate linear axis name

Set the linear axis name used for pole coordinate interpolation.

---Setting range---
 Axis name such as X, Y or Z

【#1534】 SnG44.1 Spindle No. for G44.1 command

Set the selected spindle No. for the G44.1 command.
 The setting range differs according to the model.
 If a spindle that does not exist is set, the 2nd spindle will be used. Note that if there is only one spindle, the 1st spindle will be used.
 0: 2nd spindle
 1: 1st spindle
 2: 2nd spindle
 3: 3rd spindle
 4: 4th spindle

【#1535】 C_leng Minimum turning movement amount

Set the minimum turning movement amount of the normal line control axis at the block joint during normal line control.

---Setting range---
 0.000 to 99999.999 (mm) (Input setting increment applies)

【#1537】 crsax[1]

Not used. Set to "0".

【#1538】 crsax[2]

Not used. Set to "0".

【#1539】 crsax[3]

Not used. Set to "0".

【#1540】 crsax[4]

Not used. Set to "0".

【#1541】 crsax[5]

Not used. Set to "0".

【#1542】 crsax[6]

Not used. Set to "0".

【#1543】 crsax[7]

Not used. Set to "0".

【#1544】 crsax[8]

Not used. Set to "0".

【#1545】 UclmpM Unclamping M code 1

Set the M code to unclamp the main spindle in hole drilling cycle.
 0: One-added value of the M code in "#1183 clmp_M" will be the M code for unclamping.
 Other than "0": The set value will be the M code for unclamping

---Setting range---
 0 to 99999999

【#1546】 clmp_M2 Clamping M code 2

Set the M code to clamp the sub spindle in hole drilling cycle.

---Setting range---
 0 to 99999999

【#1547】 UclmpM2 Unclamping M code 2

Set the M code to unclamp the sub spindle in hole drilling cycle.
 0: One-added value of the M code in "#1546 clmp_M2" will be the M code for unclamping.
 Other than "0": The set value will be the M code for unclamping

---Setting range---
 0 to 99999999

【#1558】 IvOMin Involute interpolation override minimum value

Set the minimum value of the involute interpolation override.

---Setting range---
 0 to 100(%)

【#1559】 IvAMax Involute interpolation tolerable acceleration

Set the maximum acceleration (time constant) when the involute interpolation acceleration clamp is enabled.

---Setting range---
 0 to 32767(ms)

【#1560】 IvFMin Involute interpolation minimum feed rate

Set the maximum feed rate when the involute interpolation acceleration clamp is enabled.

---Setting range---
 0 to 999999(mm/min)

[#1561] 3Dcdc Switch workpiece coordinate display during 3D coordinate conversion

Select the workpiece coordinate display during 3D coordinate conversion.

- 0: Workpiece coordinate system
- 1: G68.1 program coordinate system

(Note) The special display unit's absolute coordinates also follow this parameter setting.

 [#1562] 3Dremc Switch remaining command display during 3D coordinate conversion

Select the remaining command display during 3D coordinate conversion.

- 0: Workpiece coordinate system
- 1: G68.1 program coordinate system

 [#1563] 3Dcdrc Switch coordinate reading during 3D coordinate conversion

Select the coordinate system of the workpiece/skip coordinate read value in the 3D coordinate conversion modal.

- 0: Workpiece coordinate system
- 1: G68.1 program coordinate system

 [#1564] 3Dspd Hole drilling speed during 3D coordinate conversion

Select the rapid traverse rate for the hole drilling cycle during 3D coordinate conversion.

- 0: The cutting feed clamp speed is used.
- Other than 0: The set speed is used.

Note that if the rapid traverse rate is exceeded, the speed will be clamped at the rapid traverse rate.

---Setting range---

0 to 1000000mm/min

 [#1565] helgear Helical machining base axis

Set the base axis for helix angle calculation in helical machining. When no setting, Z axis will be used.

---Setting range---

Axis name such as X, Y, Z, U, V, W, A, B, and C

 [#1566] 3DSelctDrillaxMode Switch drill axis's mode from rapid traverse during 3D coordinate conversion

Select the rapid traverse mode in non-drilling blocks among a drilling cycle to the cutting feed mode during 3-dimensional coordinate conversion.

- 0: Rapid traverse mode. The speed follows the setting of "#2001 rapid".
- 1: Cutting feed mode. The speed follows the setting of "#1564 3Dspd".

* "3Ddeillax" is displayed as the parameter name on the MELDAS screen.

 [#1568] SfiltG1 G01 soft acceleration/deceleration filter

Set the filter time constant for smoothly changing the acceleration rate for the cutting feed acceleration/deceleration in pre-interpolation acceleration/deceleration.

---Setting range---

0 to 200 (ms)

 [#1569] SfiltG0 G00 soft acceleration/deceleration filter

Set the filter time constant for smoothly changing the acceleration rate for the rapid traverse acceleration/deceleration in pre-interpolation acceleration/deceleration.

---Setting range---

0 to 200 (ms)

 [#1570] Sfilt2 Soft acceleration/deceleration filter 2

Set the filter time constant for smoothly changing the acceleration rate in pre-interpolation acceleration/deceleration.

---Setting range---

0 to 50 (ms)

【#1571】 SSSdis SSS control adjustment coefficient fixed value selection

Fix the shape recognition range for SSS control.

【#1572】 Cirorp Arc command overlap

This eliminates speed fluctuations at the joint of the arc and straight line and arc and arc.
Set as a bit unit.

- 0: Do not overlap the arc command blocks
- 1: Overlap the arc command blocks

bit0 : Arc command during high-speed high-accuracy control II

bit1 : Arc command during high-speed machining mode II

bit2 : Arc command during high-accuracy control (G61.1)

bit3 : Arc command during cutting mode (G64)

The line command block and arc command block won't be overlapped during G61.2 modal regardless of this setting.

(Note) This parameter is invalid during SSS control.

【#1573】 Ret1 Return type 1

Select the axis to be moved later after tool return.

This is referred to with the movement path (transit point #1 -> interrupt point).

Up to eight axes can be specified by expressing one axis with one bit.

bit0 : Transit point #1 1st axis

bit1 : Transit point #1 2nd axis

bit2 : Transit point #1 3rd axis

bit3 : Transit point #1 4th axis

bit4 : Transit point #1 5th axis

bit5 : Transit point #1 6th axis

bit6 : Transit point #1 7th axis

bit7 : Transit point #1 8th axis

---Setting range---

00000000 to 11111111 (Binary)

【#1574】 Ret2 Return type 2

Select the axis to be moved later after tool return.
This is referred to with the movement path (return start point -> transit point #2).
Up to eight axes can be specified by expressing one axis with one bit.

bit0 : Transit point #2 1st axis**bit1 : Transit point #2 2nd axis****bit2 : Transit point #2 3rd axis****bit3 : Transit point #2 4th axis****bit4 : Transit point #2 5th axis****bit5 : Transit point #2 6th axis****bit6 : Transit point #2 7th axis****bit7 : Transit point #2 8th axis****---Setting range---**

00000000 to 11111111 (Binary)

【#1575(PR)】 rpcB1 Compensation base rotary axis 1

Set the name of the rotary axis of first group as the compensation base.

【#1576(PR)】 rpcH1 Compensation plane horizontal axis 1

Set the name of the plane horizontal axis of first group as the compensation base.

【#1577(PR)】 rpcV1 Compensation plane vertical axis 1

Set the name of the plane vertical axis of first group as the compensation base.

【#1580(PR)】 rpcB2 Compensation base rotary axis 2

Set the name of the rotary axis of second group as the compensation base.

【#1581(PR)】 rpcH2 Compensation plane horizontal axis 2

Set the name of the plane horizontal axis of second group as the compensation base.

【#1582(PR)】 rpcV2 Compensation plane vertical axis 2

Set the name of the plane vertical axis of second group as the compensation base.

【#1585(PR)】 rpcB3 Compensation base rotary axis 3

Set the name of the rotary axis of third group as the compensation base.

【#1586(PR)】 rpcH3 Compensation plane horizontal axis 3

Set the name of the plane horizontal axis of third group as the compensation base.

【#1587(PR)】 rpcV3 Compensation plane vertical axis 3

Set the name of the plane vertical axis of third group as the compensation base.

【#1594(PR)】 3DStpSel Selection for stop with machine interference check

Select the stop function when a machine interference is judged with 3D machine interference check.

0: Alarm stop

Reset to release the stop state after an axis stop command is canceled.

1: Interlock stop

A release of axis command cancels the alarm and the axis restarts to move.(No reboot required.)

【#1595】 hobm Hobbing rotary tool spindle No.

Set the axis No. of the rotary tool spindle for the hobbing command (G81.4).

---Setting range---

1 to the number of spindles

【#1596】 hobs Hobbing workpiece axis No.

Set the axis No. in the part system of the workpiece axis for the hobbing command (G81.4).

---Setting range---

1 to the number of the axis in the part system

【#1597】 rpcNoMove No axis travel with compensation amount change for rotary axis work position

Set whether to enable the axis travel for the compensation change when the compensation amount of rotary axis work position is changed.

0: Enable

1: Disable

* Regardless of the parameter setting, the axis travel is not enabled at reset.

【#1601】 axnameEx

Not used. Set to "0".

【#1801】 Hacc_c Arc radius clam acceleration**---Setting range---**

-99999999 to +99999999

【#1802】 Macc_c Acceleration check at middle speed**---Setting range---**

-99999999 to +99999999

【#1803】 Lacc_c Acceleration check at low speed**---Setting range---**

-99999999 to +99999999

【#1811】 Hcof_A X-axis high acceleration coefficient β **---Setting range---**

-99999999 to +99999999

【#1812】 Hcof_B X-axis high acceleration coefficient α **---Setting range---**

-99999999 to +99999999

【#1813】 Mcof_A X-axis middle acceleration coefficient β **---Setting range---**

-99999999 to +99999999

【#1814】 Mcof_B X-axis middle acceleration coefficient α **---Setting range---**

-99999999 to +99999999

【#1815】 Lcof_A X-axis low acceleration coefficient β **---Setting range---**

-99999999 to +99999999

【#1816】 Lcof_B X-axis low acceleration coefficient α

---Setting range---
-99999999 to +99999999

【#1817】 mag_C X-axis change magnification θ [%]

Set to "0" when no compensation or change is executed.

---Setting range---
-99999999 to +99999999

【#1821】 Hcof_A Y-axis high acceleration coefficient β

---Setting range---
-99999999 to +99999999

【#1822】 Hcof_B Y-axis high acceleration coefficient α

---Setting range---
-99999999 to +99999999

【#1823】 Mcof_A Y-axis middle acceleration coefficient β

---Setting range---
-99999999 to +99999999

【#1824】 Mcof_B Y-axis middle acceleration coefficient α

---Setting range---
-99999999 to +99999999

【#1825】 Lcof_A Y-axis low acceleration coefficient β

---Setting range---
-99999999 to +99999999

【#1826】 Lcof_B Y-axis low acceleration coefficient α

---Setting range---
-99999999 to +99999999

【#1827】 mag_C Y-axis change magnification θ [%]

Set to "0" when no compensation or change is executed.

---Setting range---
-99999999 to +99999999

【#1901(PR)】 station addr

Set the station address number which indicates that the NC is the nth slave station.

---Setting range---
1 to 7

【#1902(PR)】 Din size

Set the size of the data to be transferred from PC to NC (from master station to slave station).
Set the size in bytes (8-point unit)

---Setting range---
0 to 32 (bytes (8 bits))

【#1903(PR) Dout size

Set the size of the data to be transferred from NC to PC (from slave station to master station).
Set the size in bytes (8-point unit)

---Setting range---

0 to 32 (bytes (8 bits))

【#1904(PR) data length

Set the data length of a character.
0 to 2: 7 bits
3: 8 bits

【#1905(PR) baud rate

Select the data transfer rate.
The transfer rate differs according to the operation clock frequency.

Clock: 6MHz / 10MHz
0: 38400 / 57600
1: 19200 / 28800
2: 9600 / 14400
3: 4800 / 7200
4: 2400 / 3600
5: 1200 / 1800
6: 600 / 900
(bps)

【#1906(PR) stop bit

Set the stop bit length.
0, 1: 1 bits
2, 3: 2 bits

【#1907(PR) parity check

Select whether to enable parity check.
0: Disable
1: Enable

【#1908(PR) even parity

Select either odd or even parity bit.
This parameter value is ignored if parity check is disabled.
0: Odd parity
1: Even parity

【#1909(PR) Tout (ini)

Set the time-out duration from the end of the connection check sequence to the completion of the first usual sequence (input).
If the time-out time has exceeded this value, an emergency stop occurs and the system waits for the preparation sequence to start.
If "0" is set, no time-out error occurs. Therefore, no communication stop is detected.

---Setting range---

0 to 999 (0.1s)

【#1910(PR) Tout (run)

Set the time-out duration from when the NC (slave station) outputs usual sequence data to when the next usual sequence data is input.
If the time-out time has exceeded this value, an emergency stop occurs and the system waits for the preparation sequence to start.
If "0" is set, no time-out error occurs. Therefore, no communication stop is detected.

---Setting range---

0 to 999 (0.1s)

【#1911(PR)】 clock select

Select the operation clock frequency.

0: 6MHz

1: 10MHz

【#1925】 EtherNet Start of service

Start or stop the Ethernet communication function.

0: Stop

1: Start

【#1926(PR)】 IP address

Set the main CPU's IP address.

Set the NC IP address seen from an external source.

【#1927(PR)】 Subnet mask

Set the subnet mask for the IP address.

【#1928(PR)】 Gateway address

Set the IP address for the gateway.

【#1929】 Port number

Not used. Set to "0".

【#1930(PR)】 Host address

Not used. Set to "0".

【#1931(PR)】 Host number

Not used. Set to "0".

【#1932】 FTP Retry FTP communication retries

Set the number of automatic retries for FTP communication failure.

---Setting range---

0 to 999 (times)

【#1933】 FTP Timeout FTP communication time-out time

Set the communication time-out duration for the automatic retry of FTP communication.

Setting value "0" means 10 seconds of time-out, which is default value.

---Setting range---

0 to 99 (seconds)

【#1934(PR)】 Local IP address

Set the HMI side CPU's IP address.

【#1935(PR)】 Local Subnet mask

Set the HMI side CPU's subnet mask.

【#1942(PR)】 Local IP address2

Set the display side CPU's IP address 2.

Set NC's IP address 2 seen from an external source.

The IP address 2 set in this parameter can communicate with the client computer.

【#11005(PR) PC IP address PC IP address

Set the IP address for the PC in which machining programs are stored.
Specify "0.0.0.0" for the device connected with the display unit.

---Setting range---
0.0.0.0 to 255.255.255.255

【#11011 Handy TERM. PW.

Not used. Set to "0".

【#11012(PR) 16 axes for 1ch Connecting 16 axes for 1ch

Set to "0" for M system.
Set to "2" for L system.

【#11017 T-ofs set at run

Not used. Set to "0".

【#11019 2-system display

Not used. Set to "0".

【#11022 SRAM Output Type

Set to "0".

【#11028 Tolerance Arc Cent Tolerable correction value of arc center error

Set the tolerable correction value for the calculated coordinate value error of R-specified circular center.
When a difference between "a line between the start and end points" and "commanded radius x 2" is the tolerance or smaller, the error is corrected so that the middle of a line between the start and end points will be the arc center.

When [Setting value < 0] : 0 (Not correct)
When [Setting value = 0] : 2 x minimum setting increment
When [Setting value > 0] : Setting value

---Setting range---
-1 to 0.100(mm)

【#11029 Arc to G1 no Cent Change command from arc to linear when no arc center designation

Select the operation when arc center or radius designation is omitted from arc command.
0: Program error
1: Change into linear command

【#11030 Man tap sync cancel Synchronization cancel in manual synchronous tapping

Select whether the tapping axis in manual synchronous tapping synchronizes with the spindle.
0: Synchronize with the spindle
1: Not synchronize with the spindle

【#11033(PR)】 skipB_no_sens Unconnected sensor selection when skip is set to contact B

Select the contact of the sensor which you wish to set as unconnected, when the skip signal is set to contact B.

Set "1" for the contact to be unconnected.

bit0: Skip input 1

bit1: Skip input 2

bit2: Skip input 3

bit3: Skip input 4

bit4: Skip input 5

bit5: Skip input 6

bit6: Skip input 7

bit7: Skip input 8

(Note 1) This parameter is enabled when "#1258 set30/bit0" is set to "1".

(Note 2) This parameter is independent of PLC skip.

---Setting range---

00000000 to 11111111 (Binary)

【#11034】 G12AddrCheckType Command address type to check in circular cutting

Select the type of command address to check in circular cutting.

0: Regard command addresses other than D, F, I as illegal.

1: Regard the command address H as illegal. And commands other than D,F,I and M,S,T,B are disabled.

【#11036】 meas_dir_judge Non-sensitive band for manual measurement direction judgment (for M system only)

Set the non-sensitive band to be used for judging the manual measurement direction. If the feedback position fluctuates widely at the axis stop, set the fluctuation width or larger value in this set the parameter.

When set to "0", the band will be 1 (μm).

---Setting range---

0 to 1000 (μm)

0: 1 (μm)

【#11040】 RRAGOut1L Start No. for output range 1

Set a start No. of R resistor for Output range 1.

---Setting range---

28300 to 29299

【#11041】 RRAGOut1H Finish No. for output range 1

Set a finish No. of R resistor for Output range 1.

---Setting range---

28300 to 29299

【#11051】 Direct Socket OFF Direct Socket communication I/F OFF

Select ON/OFF of the Direct Socket communication I/F.

0: ON (Default)

1: OFF

【#11601(PR)】 FL_Enable FL-net Enable/disable

Changeover to enable/disable FL-net.

0: Disalbe

1: Enable

【#11602(PR)】 FL_MyIp FL-net local node IP address

Specify The IP(class C) address of the local node on FL-net.

---Setting range---

0.0.0.0 to 255.255.255.255

【#11603(PR) FL_TokenWatch Token watch time

Specify the maximum time(ms) in which FL*-net card can hold the communication right on FL-net.

---Setting range---
0 to 255

【#11604(PR) FL_MinFrameT FL-net minimum frame interval

Specify a time from the communication right acquisition to the data transmission par 0.1(ms).

---Setting range---
0 to 50

【#11605(PR) FL_NodeName FL-net node name

Set a local node name with 10 characters or less.

【#11606(PR) FL_melAPI_T1 FL-net melAPI high-speed processing cycle

Set a cyclic transmission cycle of the communication application between FL-net cards.

---Setting range---
0 to 255

【#11621(PR) FL_CyC1_MyAd Area 1 Local node common memory address

<Cyclic transmission area 1 local node>

Set a head address of data storage destination on the common memory to send data from NC to the common memory.

---Setting range---
0000 to 01FF

【#11622(PR) FL_CyC1_MyDv Area 1 Local node transfer source device

<Cyclic transmission area 1 local node>

Set a head address of data storage destination on the common memory to send data from NC.

---Setting range---
R0 to R32767
D0 to D2047

【#11623(PR) FL_CyC1_MyCt Area 1 Local node transfer size

<Cyclic transmission area 1 local node>

Set a size per word to send data from NC to the common memory.
0 disable to transfer data.

---Setting range---
0 to 512

【#11624(PR) FL_CyC1_A1Ad Area 1 Other node 1 common memory address

<Cyclic transmission area 1 other node 1>

Set a head address of data storage destination on the common memory to receive data from the common memory in NC.

---Setting range---
0000 to 01FF

【#11625(PR) FL_CyC1_A1Dv Area 1 Other node 1 transfer source device

<Cyclic transmission area 1 other node 1>

Set a head of PLC device to receive data from the common memory in NC.

---Setting range---
R0 to R32767
D0 to D2047

【#11626(PR)】 FL_CyC1_A1Ct Area 1 Other node 1 transfer device

<Cyclic transmission area 1 other node 1>
Set a size per word to receive data form the common memory in NC.
0 disable to transfer data.

---Setting range---
0 to 512

【#11627(PR)】 FL_CyC1_A2Ad Area 2 Other node 2 common memory address

<Cyclic transmission area 1 other node 2>
Set a head address of data storage destination on the common memory to receive data from the common memory in NC.

---Setting range---
0000 to 01FF

【#11628(PR)】 FL_CyC1_A2Dv Area 2 Other node 2 transfer device source

<Cyclic transmission area 1 other node 2>
Set a head of PLC device to receive data from the common memory in NC.

---Setting range---
R0 to R32767
D0 to D2047

【#11629(PR)】 FL_CyC1_A2Ct Area 2 Other node 2 transfer size

<Cyclic transmission area 1 other node 2>
Set a size per word to receive data form common memory in NC.
0 disable to transfer data.

---Setting range---
0 to 512

【#11631(PR)】 FL_CyC2_MyAd Area 2 Local node common memory address

<Cyclic transmission area 2 local node>
Set a head address of data storage destination on the common memory to send data from NC to the common memory.

---Setting range---
0000 to 01FF

【#11632(PR)】 FL_CyC2_MyDv Area 2 Other node 2 common memory address

<Cyclic transmission area 2 other node 1>
Set a head address of data storage destination on the common memory to send data from NC to the common memory.

---Setting range---
R0 to R32767
D0 to D2047

【#11633(PR)】 FL_CyC2_MyCt Area 2 Local node transfer size

<Cyclic transmission area 2 local node>
Set a size per word to receive data form the common memory in NC.
0 disable to transfer data.

---Setting range---
0 to 512

【#11634(PR)】 FL_CyC2_A1Ad Area 2 Other node 1 common memory address

<Cyclic transmission area 2 local node 1>
Set a head address of data storage destination on the common memory to receive data from the common memory in NC.

---Setting range---
0000 to 01FF

【#11635(PR) FL_CyC2_A1Dv Area 2 Other node 1 transfer source device

<Cyclic transmission area 2 other node 1>
Set a head of PLC device to receive data from the common memory in NC.

---Setting range---
R0 to R32767
D0 to D2047

【#11636(PR) FL_CyC2_A1Ct Area 2 Other node 1 transfer size

<Cyclic transmission area 2 Other node 1>
Set a size per word to receive data from the common memory in NC.
0 disable to transfer data.

---Setting range---
0 to 512

【#11637(PR) FL_CyC2_A2Ad Area 2 Other node 2 common memory address

<Cyclic transmission area 2 local node 2>
Set a head address of data storage destination on the common memory to receive data from the common memory in NC.

---Setting range---
0000 to 01FF

【#11638(PR) FL_CyC2_A2Dv Area 2 Other node 2 transfer source device

<Cyclic transmission area 2 other node 2>
Set a head of PLC device to receive data from the common memory in NC.

---Setting range---
R0 to R32767
D0 to D2047

【#11639(PR) FL_CyC2_A2Ct Area 2 Other node 2 transfer size

<Cyclic transmission area 2 Other node 2>
Set a size per word to receive data from the common memory in NC.
0 disable to transfer data.

---Setting range---
0 to 512

【#12001 ManualB RectanA xH Manual feed rate B constant surface control intersecting part system axis name (horizontal)

Set the part system axis name ("#1013 axname") for the two axes that intersect with the rotary axis direction. When one of the two axes is blank, a constant speed will be applied without using constant surface speed control.

---Setting range---
Axis addresses such as X, Y, Z, U, V, W, A, B, and C

【#12002 ManualB RectanA xV Manual feed rate B constant surface control intersecting part system axis name (vertical)

Set the part system axis name ("#1013 axname") for the two axes that intersect with the rotary axis direction. When one of the two axes is blank, a constant speed will be applied without using constant surface speed control.

---Setting range---
Axis addresses such as X, Y, Z, U, V, W, A, B, and C

【#12003】 ManualB RotCent erH Manual feed rate B constant surface control rotation center machine position (horizontal)

Set the machine coordinate position (horizontal axis) at the center of the rotary axis.

---Setting range---

-99999.999 to 99999.999 (mm)

【#12004】 ManualB RotCent erV Manual feed rate B constant surface control rotation center machine position (vertical)

Set the machine coordinate position (vertical axis) at the center of the rotary axis.

---Setting range---

-99999.999 to 99999.999 (mm)

【#12022】 skipF_spec Skip speed specification

Set the specification on the feed of G31 Skip specification.

bit0: Cutting feed override

0: Disable cutting feed override
1: Enable cutting feed override

bit1: Enable dry run

0: Disable dry run
1: Enable dry run

bit2: G31 changeover feed rate

0: The value of the address F commanded in G31 block
Or, the value set at "#1174" without the address F in G31 block
1: The value of F modal commanded in the program

【#12023(PR)】 Mblkstp1 Pre-reading prohibition M code 1

Set M code witch is not enable to pre-reading.

---Setting range---

0 to 99999999

【#12024(PR)】 Mblkstp2 Pre-reading prohibition M code 2

Set M code witch is not enable to pre-reading.

---Setting range---

0 to 99999999

【#12025(PR)】 Mblkstp3 Pre-reading prohibition M code 3

Set M code witch is not enable to pre-reading.

---Setting range---

0 to 99999999

【#12026(PR)】 Mblkstp4 Pre-reading prohibition M code 4

Set M code witch is not enable to pre-reading.

---Setting range---

0 to 99999999

【#12027(PR)】 Mblkstp5 Pre-reading prohibition M code 5

Set M code witch is not enable to pre-reading.

---Setting range---

0 to 99999999

【#12028(PR) Mblkstp6 Pre-reading prohibition M code 6

Set M code witch is not enable to pre-reading.

---Setting range---
0 to 99999999

【#12029(PR) Mblkstp7 Pre-reading prohibition M code 7

Set M code witch is not enable to pre-reading.

---Setting range---
0 to 99999999

【#12030(PR) Mblkstp8 Pre-reading prohibition M code 8

Set M code witch is not enable to pre-reading.

---Setting range---
0 to 99999999

【#12031(PR) Mblkstp9 Pre-reading prohibition M code 9

Set M code witch is not enable to pre-reading.

---Setting range---
0 to 99999999

【#12032(PR) Mblkstp10 Pre-reading prohibition M code 10

Set M code witch is not enable to pre-reading.

---Setting range---
0 to 99999999

【#12033(PR) MblkstpMin1 Pre-reading prohibition minimum value of setting rage 1

Set the minimum value of M code witch is not enable to pre-reading.

---Setting range---
0 to 99999999

【#12034(PR) MblkstpMax1 Pre-reading prohibition maximum value of setting rage 1

Set the maxmum value of M code witch is not enable to pre-reading.

---Setting range---
0 to 99999999

【#12035(PR) MblkstpMin2 Pre-reading prohibition minimum value of setting rage 2

Set the minimum value of M code witch is not enable to pre-reading.

---Setting range---
0 to 99999999

【#12036(PR) MblkstpMax2 Pre-reading prohibition maximum value of setting rage 2

Set the maxmum value of M code witch is not enable to pre-reading.

---Setting range---
0 to 99999999

【#12037(PR) MblkstpMin3 Pre-reading prohibition minimum value of setting rage 3

Set the minimum value of M code witch is not enable to pre-reading.

---Setting range---
0 to 99999999

【#12038(PR)】 MblkstpMax3 Pre-reading prohibition maximum value of setting rage 3

Set the maximum value of M code witch is not enable to pre-reading.

---Setting range---
0 to 99999999

【#12039(PR)】 MblkstpMin4 Pre-reading prohibition minimum value of setting rage 4

Set the minimum value of M code witch is not enable to pre-reading.

---Setting range---
0 to 99999999

【#12040(PR)】 MblkstpMax4 Pre-reading prohibition maximum value of setting rage 4

Set the maximum value of M code witch is not enable to pre-reading.

---Setting range---
0 to 99999999

【#12041(PR)】 MblkstpMin5 Pre-reading prohibition minimum value of setting rage 5

Set the minimum value of M code witch is not enable to pre-reading.

---Setting range---
0 to 99999999

【#12042(PR)】 MblkstpMax5 Pre-reading prohibition maximum value of setting rage 5

Set the maximum value of M code witch is not enable to pre-reading.

---Setting range---
0 to 99999999

【#12043(PR)】 MblkstpMin6 Pre-reading prohibition minimum value of setting rage 6

Set the minimum value of M code witch is not enable to pre-reading.

---Setting range---
0 to 99999999

【#12044(PR)】 MblkstpMax6 Pre-reading prohibition maximum value of setting rage 6

Set the maximum value of M code witch is not enable to pre-reading.

---Setting range---
0 to 99999999

【#12045】 retract_INC Select retract command mode

Select whether to follow the absolute/incremental command mode or only use the incremental command for G10.6 command of the tool retract and return 2.

0: Follow the absolute/incremental command mode at G10.6 command
1: Always use the incremental command

【#12046】 reposit_SBLK Operation after repositioning

Select an operation after repositioning with tool retract and return 2.

0: Automatic operation is restarted from the operation state at retract start.
1: The operation is stopped when the single block switch is ON. Automatic operation is restarted by performing the cycle start again.

【#12047】 G10.6_type G10.6 independent command operation changeover

Select an operation with G10.6 commanded independently and tool retract signal.

0: Disable retract
1: Enable retract for the value set at parameter #8223 as the increased retract amount.

【#12700】 P1-bF Parameter group 1: Maximum speed

Set the maximum speed (corresponding to #1206 G1bF) for heavy workpiece parameter group 1 in optimum acceleration/deceleration selection.

---Setting range---
1 to 1000000 (mm/min)

【#12701】 P1-btL Parameter group 1: Time constant

Set the time constant (corresponding to #1207 G1btL) for heavy workpiece parameter group 1 in optimum acceleration/deceleration selection.

---Setting range---
0 to 5000 (ms)

【#12702】 P1-SfG1 Parameter group 1: G01 Soft acceleration/deceleration filter

Set the G01 soft acceleration/deceleration filter (corresponding to #1568 SfiltG1) for heavy workpiece parameter group 1 in optimum acceleration/deceleration selection.

---Setting range---
0 to 200 (ms)

【#12703】 P1-SfG0 Parameter group 1: G00 soft acceleration/deceleration filter

Set the G00 soft acceleration/deceleration filter (corresponding to #1569 SfiltG0) for heavy workpiece parameter group 1 in optimum acceleration/deceleration selection.

---Setting range---
0 to 200 (ms)

【#12720】 P2-bF Parameter group 2: Maximum speed

Set the maximum speed (corresponding to #1206 G1bF) for heavy workpiece Parameter group 2 in optimum acceleration/deceleration selection.

---Setting range---
1 to 1000000 (mm/min)

【#12721】 P2-btL Parameter group 2: Time constant

Set the time constant (corresponding to #1207 G1btL) for heavy workpiece Parameter group 2 in optimum acceleration/deceleration selection.

---Setting range---
0 to 5000 (ms)

【#12722】 P2-SfG1 Parameter group 2: G01 Soft acceleration/deceleration filter

Set the G01 soft acceleration/deceleration filter (corresponding to #1568 SfiltG1) for heavy workpiece Parameter group 2 in optimum acceleration/deceleration selection.

---Setting range---
0 to 200 (ms)

【#12723】 P2-SfG0 Parameter group 2: G00 soft acceleration/deceleration filter

Set the G00 soft acceleration/deceleration filter (corresponding to #1569 SfiltG0) for heavy workpiece Parameter group 2 in optimum acceleration/deceleration selection.

---Setting range---
0 to 200 (ms)

【#12740】 P3-bF Parameter group 3: Maximum speed

Set the maximum speed (corresponding to #1206 G1bF) for heavy workpiece Parameter group 3 in optimum acceleration/deceleration selection.

---Setting range---
1 to 1000000 (mm/min)

【#12741】 P3-btL Parameter group 3: Time constant

Set the time constant (corresponding to #1207 G1btL) for heavy workpiece Parameter group 3 in optimum acceleration/deceleration selection.

---Setting range---
0 to 5000 (ms)

【#12742】 P3-SfG1 Parameter group 3: G01 Soft acceleration/deceleration filter

Set the G01 soft acceleration/deceleration filter (corresponding to #1568 SfiltG1) for heavy workpiece Parameter group 3 in optimum acceleration/deceleration selection.

---Setting range---
0 to 200 (ms)

【#12743】 P3-SfG0 Parameter group 3: G00 soft acceleration/deceleration filter

Set the G00 soft acceleration/deceleration filter (corresponding to #1569 SfiltG0) for heavy workpiece Parameter group 3 in optimum acceleration/deceleration selection.

---Setting range---
0 to 200 (ms)

【#39001(PR)】 WkType1 Workpiece coordinate standard offset X selection

Select the configuration of workpiece coordinate system.

0: External workpiece offset values are user-open.

1: External workpiece offset value for X axis is the distance from the machine coordinate system zero point to the workpiece coordinate system zero point. Workpiece offset values are allowed to be user-open when the offset amount is decided along the tool shape.

【#39002】 WkComnX Workpiece coordinate standard offset amount X

Set the offset amount (radius value) from the workpiece coordinate zero point to the machine coordinate system zero point.

The set amount is applied to the external workpiece offset value (diameter value) for X axis when "#39001 WkType1" is set to "1".

The sign indication depends on the "#1237 set09/bit0 (External workpiece offset sign reversing)" setting.

The set value is invalid when "#39001 WkType1" is set to "0".

---Setting range---
-99999.999 to 99999.999

【#39003】 tlmr_ov Tool setter repeat Override clamp

Set the override clamp value at the positioning.

(When "0" is set, the standard value (10%) is internally applied.)

---Setting range---
1 to 100 (%)

【#39004】 tlmr_f Tool setter repeat Contacting speed

Set the feed rate toward the sensor.

<Standard feed rate: 100mm/min>

---Setting range---
1 to 999999 (mm/min)

【#39005】 tlmr_rf Tool setter repeat Returning speed

Set the feed rate when bringing the axis back from the contact and stop position.

<Standard feed rate: 2,000 mm/min>

---Setting range---
1 to 999999 (mm/min)

【#39006】 tlmr_ep Tool setter repeat Contact command end point

Set the stopper amount from the end face of sensor, which designates the contact command end point toward sensor.

<Standard amount: 1.500 mm>

---Setting range---

0 to 99.999 (mm)

【#39007】 tlmr_ap Tool setter repeat Approach amount (clearance amount from sensor)

Set the clearance amount from the end face of sensor, which designates the contact start point toward sensor.

From the repeated-measurement start position to this start point, the tool moves at the feed rate specified in the selected mode.

<Standard amount: 3.000 mm>

---Setting range---

0 to 99999.999 (mm)

【#39008】 tlmr_rc Tool setter repeat Right-hand tool clearance amount (main spindle)

Set the clearance amount of the tools which have a nose point 2, 3, 7, 9 or 0.

The tool moves along two axes from the repeated-measurement start position to the start point designated by this parameter.

<Standard amount: 5.000 mm>

---Setting range---

-99999.999 to 99999.999 (mm)

【#39009】 tlmr_lc Tool setter repeat Left-hand tool clearance amount (main spindle)

Set the clearance amount of the tools which have a nose point 1, 4, 5, 6 or 8.

The tool moves along two axes from the repeated-measurement start position to the start point designated by this parameter.

<Standard amount: 50.000 mm>

---Setting range---

-99999.999 to 99999.999 (mm)

【#39010】 tlmr_2rc Tool setter repeat Right-hand tool clearance amount (sub spindle)

Set the clearance amount of the tools which have a nose point 2, 3, 7, 9 or 0.

The tool moves along two axes from the repeated-measurement start position to the start point designated by this parameter.

<Standard amount: 5.000 mm>

---Setting range---

-99999.999 to 99999.999 (mm)

【#39011】 tlmr_2lc Tool setter repeat Left-hand tool clearance amount (sub spindle)

Set the clearance amount of the tools which have a nose point 1, 4, 5, 6 or 8.

The tool moves along two axes from the repeated-measurement start position to the start point designated by this parameter.

<Standard amount: 50.000 mm>

---Setting range---

-99999.999 to 99999.999 (mm)

【#39351(PR)】 OprRecBlk1 Operation history record device 1

Set a PLC device to record operation history.

Record 128 devices from the setting device.

---Setting range---

M0 to M10239

【#39352(PR)】 OprRecBlk1_Num Number of operation history record device 1

Set a number of history record to record in operation history.

The set number $\times 8 =$ the number to record.

* Setting is allowed to 26 for total form #39352OprRecBlk1_Num to #39427OprRecBlk16_Num

* When the default value 0(zero) is defined and M device is set for the operation history record device 1, 16 is et.

(The indication on the setting monitor stays at 0(zero).)

* A set value out of the setting range causes "setting error".

---Setting range---

0 to 26

【#39356+5n(PR) (n=0-14)】 OprRecBlk2-16 Operation history record device 2-16

Set a number of history record to record in operation history.

Set devices among X,Y,F,M,B,C,L,SB,SM,ST,T,V to record their operation and a record start number.

Example) M9000, X1FF0, etc.

The recording start number is a multiple of eight. If another number than eight is specified, a multiple of eight including that set number is set.

Example) If M10 is set, M8 is set.

(The indication on the setting monitor stays at 10.)

* When the default value 0(zero) is defined, setting is blank(no record).

(The display is blank on the setting monitor.)

* A set value out of the setting range causes "setting error".

---Setting range---

X0 ~ X1FFF

Y0 ~ Y1FFF

F0 ~ F1023

M0 ~ M10239

B0 ~ B1FFF

C0 ~ C255

C1000 ~ C1255

L0 ~ L511

SB0 ~ SB1FF

SM0 ~ SM1023

ST0 ~ ST63

ST1000 ~ ST1063

T0 ~ T703

T1000 ~ T1703

V0 ~ V255

【#39357+5n(PR) (n=0-14)】 OprRecBlk2_Num-16_Num Number of operation history record device 2-16

Set a number of history record to record in operation history.

The set number $\times 8 =$ the number to record.

* Setting is allowed to 26 for total form #39352OprRecBlk1_Num to #39427OprRecBlk16_Num

* When the default value 0(zero) is defined, 0(no record) is set.

* A set value out of the setting range causes "setting error".

---Setting range---

0 to 26

2.4 Axis Specifications Parameters

The parameters with "(PR)" requires the CNC to be turned OFF after the settings. Turn the power OFF and ON to enable the parameter settings.

【#2001】 rapid Rapid traverse rate

Set the rapid traverse feedrate for each axis.

(Note) The maximum value to be set depends on the machine specifications.

---Setting range---

1 to 1000000 (mm/min)

【#2002】 clamp Cutting feedrate for clamp function

Set the maximum cutting feedrate for each axis.

Even if the feedrate in G01 exceeds this value, the clamp will be applied at this feedrate.

---Setting range---

1 to 1000000 (mm/min)

[#2003(PR)] smgst Acceleration and deceleration modes

Set acceleration and deceleration control modes.
Set value is in hexadecimal.

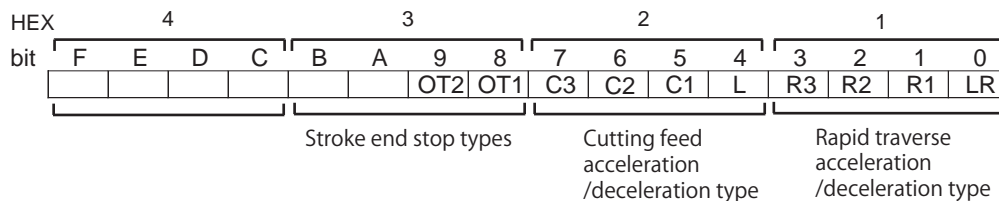

HEX-1 Rapid traverse acceleration/deceleration type

- 0(bit3,2,1,0 = 0000) : Step
- 1(bit3,2,1,0 = 0001) : Linear acceleration/deceleration
- 2(bit3,2,1,0 = 0010) : Prim ary delay
- 8(bit3,2,1,0 = 1000) : Exponential acceleration and linear deceleration
- F(bit3,2,1,0 = 1111) : Soft acceleration/deceleration

(Note) R1 > R3 when both R1 and R3 contain 1.

HEX-2 Cutting feed acceleration/deceleration type

- 0(bit7,6,5,4 = 0000) : Step
- 1(bit7,6,5,4 = 0001) : Linear acceleration/deceleration
- 2(bit7,6,5,4 = 0010) : Prim ary delay
- 8(bit7,6,5,4 = 1000) : Exponential acceleration and linear deceleration
- F(bit7,6,5,4 = 1111) : Soft acceleration/deceleration

HEX-3 Stroke end stop types

- 0(bit9,8 = 00) : Linear deceleration (Decelerates at G0t1)
- 1(bit9,8 = 01) : Linear deceleration (Decelerates at 2xG0t1)
- 2(bit9,8 = 10) : Position loop step stop
- 3(bit9,8 = 11) : Position loop step stop

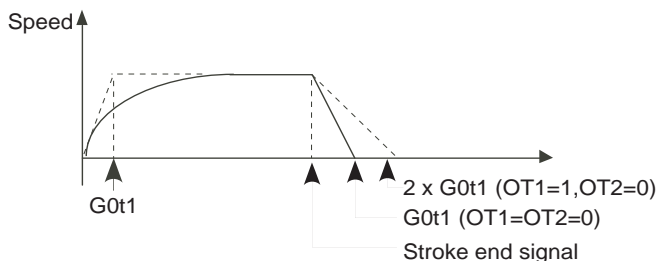

(Note) OT1(bit8) is valid under the following conditions (valid for dog type zero point return):
 - Stop type: Linear deceleration
 - Acceleration/Deceleration mode: Exponential acceleration and Linear deceleration

HEX-4

Not used. Set to "0".

【#2004】 G0tL G0 time constant (linear)

Set a linear control time constant for rapid traverse acceleration and deceleration. The time constant will be enabled when LR (rapid traverse feed with linear acceleration/deceleration) or F (soft acceleration/deceleration) is selected in "#2003 smgst Acceleration and deceleration modes".

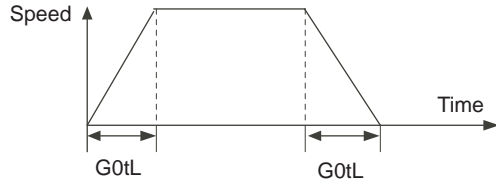

---Setting range---
1 to 4000 (ms)

【#2005】 G0t1 G0 time constant(primary delay) / Second-step time constant for soft acceleration/deceleration

Set a primary-delay time constant for rapid traverse acceleration and deceleration. The time constant will be enabled when R1 (rapid traverse feed with primary delay) or R3 (exponential acceleration and linear deceleration) is selected in "#2003 smgst Acceleration and deceleration modes". When the soft acceleration/deceleration is selected, the second-step time constant will be used.

<Rapid traverse feed with primary delay>

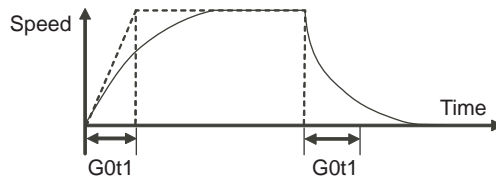

<Rapid traverse feed with exponential acceleration and linear deceleration>

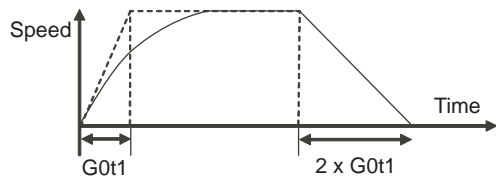

<Soft acceleration/deceleration>

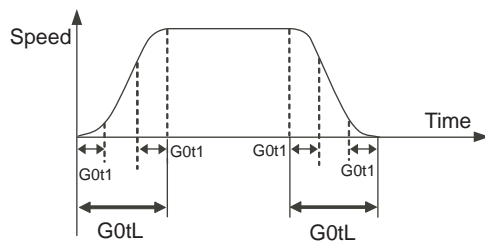

---Setting range---
1 to 5000 (ms)

【#2006】 G0t2

Not used. Set to "0".

【#2007】 G1tL G1 time constant (linear)

Set a linear control time constant for cutting acceleration and deceleration.
The time constant will be enabled when LC (cutting feed with linear acceleration/deceleration) or F (soft acceleration/deceleration) is selected in "#2003 smgst Acceleration or deceleration modes".

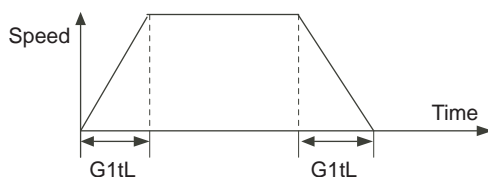

---Setting range---
1 to 4000 (ms)

【#2008】 G1t1 G1 time constant (primary delay)/Second-step time constant for soft acceleration/deceleration

Set the primary delay time constant for cutting acceleration and deceleration.
The time constant will be enabled when C1 (cutting feed with the primary delay) or C3 (cutting feed with exponential acceleration and linear deceleration) is selected in "#2003 smgst acceleration/ deceleration modes".

When the soft acceleration or deceleration is selected, the second-step time constant will be used.

<Cutting feed with primary delay>

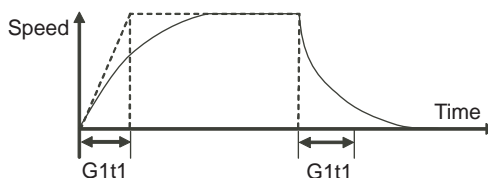

<Cutting feed with exponential acceleration and linear deceleration>

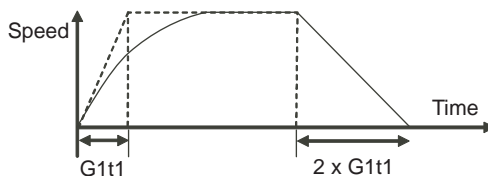

<Soft acceleration/deceleration>

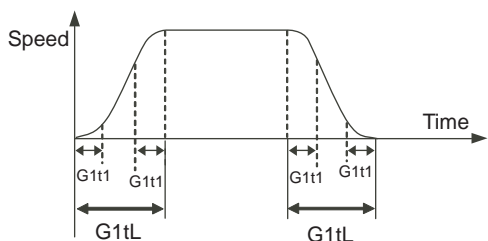

---Setting range---
1 to 5000 (ms)

【#2009】 G1t2

Not used. Set to "0".

【#2010】 fwd_g Feed forward gain

Set a feed forward gain for pre-interpolation acceleration/deceleration.
The larger the set value, the smaller the theoretical control error will be. However, if a machine vibration occurs, set the smaller value.

---Setting range---
0 to 200 (%)

【#2011】 G0back G0 backlash

Set up the backlash compensation amount when the direction is reversed with the movement command in rapid traverse feed mode or in manual operation(except for handle feed mode).
The unit of the set value depends on the unit of input setting. When "#1003 = B", the unit is 0.5 μ m. When "#1003 = C" is 0.05 μ m.

---Setting range---
-9999999 to 9999999

【#2012】 G1back G1 backlash

Set up the backlash compensation amount when the direction is reversed with the movement command in cutting feed mode.
G1 backlash is enabled in handle feed mode.
The unit of the setting value depends on the unit of input setting. When "#1003 = B", the unit is 0.5 μ m. When "#1003 = C", the unit is 0.05 μ m.

---Setting range---
-9999999 to 9999999

【#2013】 OT - Soft limit I -

Set a soft limit area with reference to the zero point of the basic machine coordinate. Set the coordinate in the negative direction for the movable area of stored stroke limit 1. The coordinate in the positive direction is set in "#2014 OT+".
To narrow the available range in actual use, use the parameters "#8204 OT-" and "#8205 OT+".
When the same value (other than "0") is set in this parameter and "#2014 OT+", this function will be disabled.

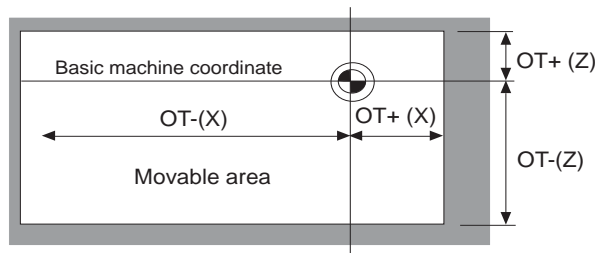

---Setting range---
-99999.999 to 99999.999 (mm)

【#2014】 OT + Soft limit I +

Set a soft limit area with reference to the zero point of the basic machine coordinate. Set the coordinate in the positive direction for the movable area of stored stroke limit 1. The coordinate in the negative direction is set in "#2013 OT-".

To narrow the available range in actual use, use the parameters "#8204 OT-" and "#8205 OT+". When the same value (other than "0") is set in this parameter and "#2013 OT-", this function will be disabled.

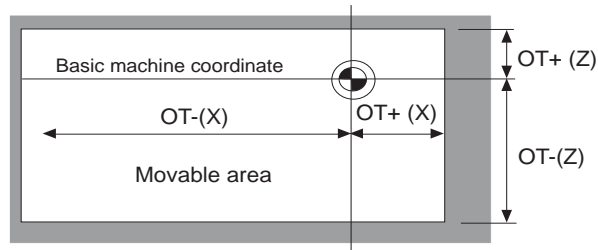

---Setting range---

-99999.999 to 99999.999 (mm)

【#2015】 tlml- Negative direction sensor of tool setter

Set a sensor position in the negative direction when using the tool setter.

(Note) In the case of the basic axis and inclined axis of the inclined axis specifications, set the position on the orthogonal coordinate.

---Setting range---

-99999.999 to 99999.999 (mm)

【#2016】 tlml+ Positive direction sensor of tool setter or TLM standard length

Set the sensor position in the positive direction when using the tool setter.

When the TLM is used, set the distance from a tool change point (reference position) to the measurement basic point (surface) in order to measure the tool length.

(Note) In the case of the basic axis and inclined axis of the inclined axis specifications, set the position on the orthogonal coordinate.

---Setting range---

-99999.999 to 99999.999 (mm)

【#2017】 tap_g Axis servo gain

Set the position loop gain for special operations (synchronized tapping, interpolation with spindle C axis, etc.).

Set the value in 0.25 increments.

The standard setting value is "10".

---Setting range---

0.25 to 200.00 (rad/s)

【#2018(PR)】 no_srv Operation with no servo control

Select when performing test operation without connecting the drive unit and motor.

0: Normal operation

1: Test operation

When "1" is set, the operation will be possible even if drive units and motor are not connected, because the drive system alarm will be ignored.

This parameter is used for test operation during start up: Do not use during normal operation. If "1" is set during normal operation, errors will not be detected even if they occur.

【#2019】 revnum Return steps

Set the steps required for reference position return for each axis.

0: Not execute reference position return.

1 to max. number of NC axes: Steps required for reference position return

【#2020】 o_chkp Spindle orientation completion check during second reference position return

Set the distance from the second reference position to the position for checking that the spindle orientation has completed during second reference position return.
When the set value is "0", the above check will be omitted.

---Setting range---
0 to 99999.999 (mm)

【#2021】 out_f Maximum speed outside soft limit range

Set the maximum speed outside the soft limit range.

---Setting range---
0 to 1000000 (mm/min)

【#2022】 G30SLX Validate soft limit (automatic and manual)

Select whether to disable a soft limit check during the second to the fourth reference position return in both automatic and manual operation modes.

0: Enable
1: Disable

【#2023】 ozfmin Set up ATC speed lower limit

Set the minimum speed outside the soft limit range during the second to the fourth reference position return.

---Setting range---
0 to 1000000 (mm/min)

【#2024】 synerr Allowable error

Set the maximum synchronization error, allowable at the synchronization error check, for the primary axis.
When "0" is set, the error check will not be carried out.

---Setting range---
0 to 99999.999 (mm)

【#2025】 G28rap G28 rapid traverse rate

Set a rapid traverse rate for the dog type reference position return command.
This is not used for the distance-coded reference position detection.

---Setting range---
1 to 1000000 (mm/min)

【#2026】 G28crp G28 approach speed

Set the approach speed to the reference position.

(Note) The G28 approach speed unit is (10°/min) only when using the Z-phase type encoder (#1226 aux10/bit3=1) for the spindle/C-axis reference position return type. The same unit is used for both the micrometric and sub-micrometric specifications.

---Setting range---
1 to 60000 (mm/min)

【#2027】 G28sft Reference position shift distance

Set the distance from the electrical zero-point detection position to the reference position.
This is not used for the distance-coded reference position detection.

---Setting range---
0.000 to 99.999 (mm)

【#2028】 grmask Grid mask amount

Set the distance where the grid point will be ignored when near-point dog OFF signals are close to that grid point during reference position return.

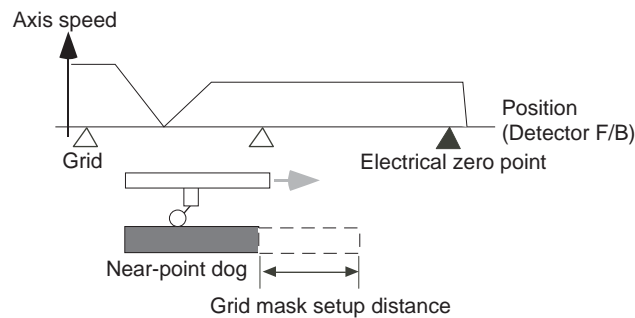

The grid mask is valid for one grid.
This is not used for the distance-coded reference position detection.

---Setting range---
0.000 to 99.999 (mm)

【#2029】 grspc Grid interval

Grid space (#2029 grspc)
Set the distance between grids.
Normally, the ball screw pitch value (#2218 PIT) or the movement amount per motor rotation is set as the grid space. To make the grid space smaller, set a divisor of the grid space.

<Calculation method for movement amount per motor rotation>

- (1) When linear feed mechanism is a ball screw:
The movement amount per motor rotation = the motor side gear ratio / the machine side gear ratio x the ball screw pitch
- (2) When linear feed mechanism is a rack and pinion:
The movement amount per motor rotation = the motor side gear ratio / the machine side gear ratio x number of pinion gear teeth x the rack pitch
- (3) For the rotary axis:
The movement angle per motor rotation = the motor side gear ratio / the machine side gear ratio x 360

---Setting range---
0.000 to 999.999 (mm)

【#2030(PR)】 dir (-) Reference position direction (-)

Select which side of the near-point dog the reference position is established.

- 0: Positive direction
- 1: Negative direction

Directions in which reference position is established as viewed from the near-point dog

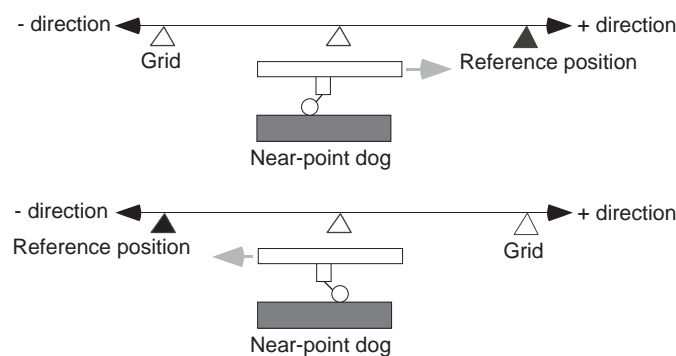

【#2031】 noref Axis without reference position

Select whether the reference position is provided for the axis.

- 0: Reference position is provided. (Normal controlled axis)
- 1: No reference position is provided.

When "1" is set, reference position return is not required before automatic operation starts.

【#2032】 nochk Whether reference position return is completed not checked

Select whether to check the reference position return completion.

0: Check the reference position return completion.

1: Not check the reference position return completion.

When "1" is set, the absolute and incremental commands can be executed even if dog type (or Z phase pulse system) reference position return is not completed.

Note that this setting is available for a rotary axis only.

【#2033】 zp_no Z phase pulse system reference position return spindle encoder No.

Set the spindle encoder No. to be used when the reference position return is performed with the Z phase pulse of the spindle encoder.

0: Dog type

1 to 6: Spindle No.

*The setting range differs according to the model.

---Setting range---

0 to 6

【#2034】 rfpos Distance-coded reference position detection offset

Set the offset value from the position for the initial reference position setting to the machine's actual basic point in reference position return in the distance-coded reference position detection.

Input the value of the machine value counter that is displayed immediately after the reference position is established.

When the power is turned ON and this parameter is set to "0", the manual reference position return is regarded as initial reference position setting.

If this parameter is set to "0", automatic operation won't be available.

---Setting range---

-99999.999 to 99999.999 (mm)

【#2035】 srchmax Distance-coded reference position detection scan distance

Set the maximum distance for scanning the reference marks when the reference position is not established in the distance-coded reference position detection.

For the scan distance, set the distance that fully covers the number of reference marks as you wish to detect.

(Example) When adding about 10% of additional coverage:

Scan distance = Base reference mark interval [mm] * 2 * 1.1

---Setting range---

0.000 to 99999.999 (mm)

[#2036] slv_adjust Reference position adjustment value

Set the distance from the first grid point after leaving the near point dog on the secondary axis to the position where the reference position is actually established in dog-type reference position return in synchronous control. (Reference position shift amount is not included.)

The adjustment value will be automatically set in the secondary axis's parameter according to the reference position adjustment complete signal from PLC.

Fine adjustment is also available from the parameter screen.

In the distance-coded reference position detection, the reference position adjustment value will be invalid.

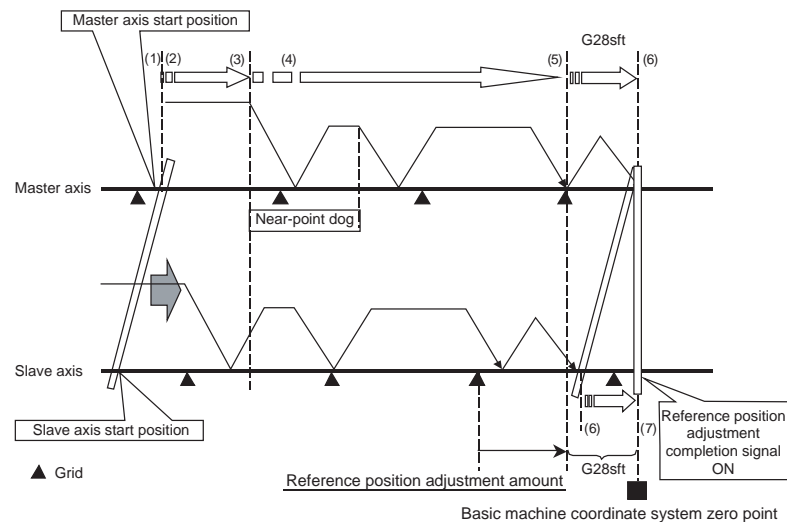

(Note 1) This parameter is enabled when the synchronization at zero point initialization ("#1493 ref_syn" = "1" of the primary axis) is applied.

(Note 2) This parameter can be set when one of the following settings is applied.

- Relative position detection ("#2049 type" = "0")
- Dog-type absolute position detection ("#2049 type" = "3")
- Simple absolute position ("#2049 type" = "9")

(Note 3) Set "0" when using the speed/current command synchronization control.

(Note 4) A setting unit of this parameter is [mm]. It is not influenced by the content of the following parameters setting.

- "#1003 iunit"
- "#1004 ctrl_unit"
- "#1005 plcunit"
- "#1040 M_inch"
- "#1041 I_inch"

(Note 5) The number of the significant digits after decimal point follows "#1004 ctrl_unit"

(Note 6) A change of this parameter requires reference position return. When the automatic operation starts without reference position return, an alarm will occur.

---Setting range---

0 to 99999.999999 (mm)

【#2037】 G53ofs Reference position #1

Set the position of the first reference position from the zero point of the basic machine coordinate.

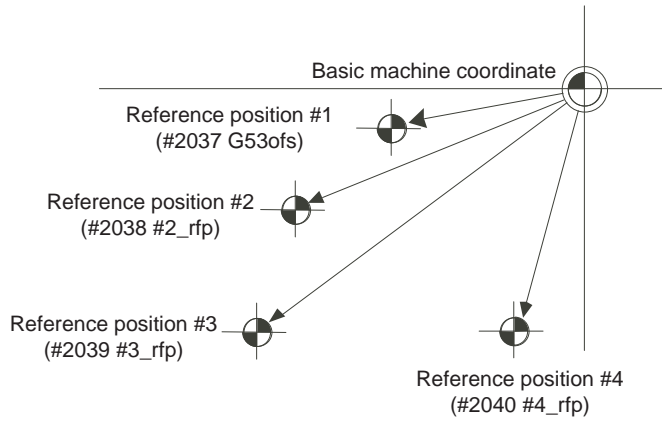

---Setting range---
-99999.999 to 99999.999 (mm)

【#2038】 #2_rfp Reference position #2

Set the position of the second reference position from the zero point of the basic machine coordinate.

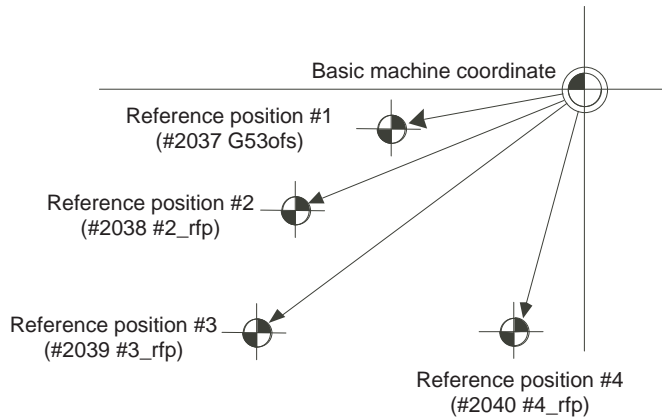

---Setting range---
-99999.999 to 99999.999 (mm)

【#2039】 #3_rfp Reference position #3

Set the position of the third reference position from the zero point of the basic machine coordinate.

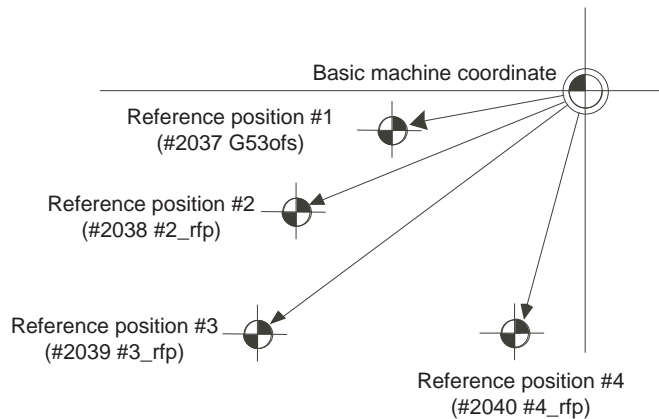

---Setting range---
-99999.999 to 99999.999 (mm)

【#2040】 #4_rfp Reference position #4

Set the position of the fourth reference position from the zero point of the basic machine coordinate.

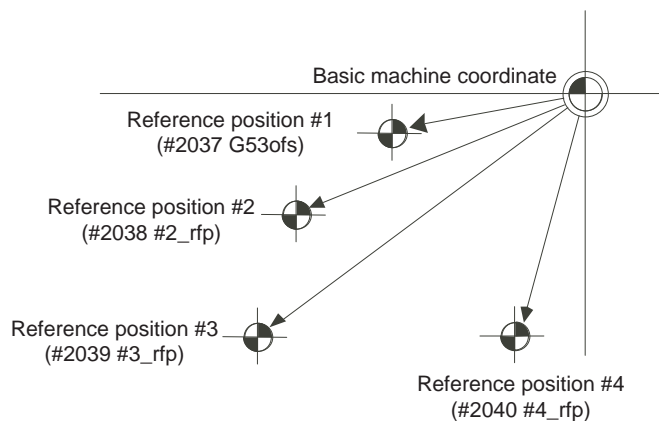

---Setting range---
-99999.999 to 99999.999 (mm)

【#2049(PR)】 type Absolute position detection method

Select the absolute position zero point alignment method.

- 0: Not absolute position detection
- 1: Stopper method (push against mechanical stopper)
- 2: Marked point alignment method I (The grid point is the reference position.)
- 3: Dog-type (align with dog and near point detection switch)
- 4: Marked point alignment method II (The position with which the mark was aligned is the reference position.)
- 9: Simple absolute position (Not absolute position detection, but the position when the power is turned off is registered.)

【#2050】 absdir Basic point of Z direction

Select the direction of the grid point immediately before the machine basic position (basic point of detector) in the marked point alignment.

- 0: Positive direction
- 1: Negative direction

【#2051】 check Check

Set the tolerable range of travel distance (deviation distance) while the power is turned OFF.
If the difference of the positions when the power is turned OFF and when turned ON again is larger than this value, an alarm will be output.
Set "0" to omit the check.

---Setting range---

0 to 99999.999 (mm)

【#2052】 absg28

Not used. Set to "0".

【#2053】 absm02

Not used. Set to "0".

【#2054】 clpush Current limit (%)

Set the current limit value during the stopper operation in the dogless-type absolute position detection.
The setting value is the ratio of the current limit value to the rated current value.

---Setting range---

0 to 100 (%)

【#2055】 pushf Push speed

Set the feedrate for the automatic initial setting during stopper method.

---Setting range---

1 to 999 (mm/min)

【#2056】 aproch Approach

Set the approach distance of the stopper when deciding the absolute position basic point with the stopper method.
After using stopper once, the tool returns with this distance, and then use stopper again.

---Setting range---

0 to 999.999 (mm)

【#2057】 nrefp Near zero point +

Set the positive direction width where the near reference position signal is output.
When set to "0", the width will be equivalent to the grid width setting.

---Setting range---

0 to 999.999 (mm)
(Input setting increment applied)

【#2058】 nrefn Near zero point -

Set the negative direction width where the near reference position signal is output.
When set to "0", the width will be equivalent to the grid width setting.

---Setting range---

0 to 999.999 (mm)
(Input setting increment applied)

【#2059】 zerbas Select zero point parameter and basic point

Select which is to be the zero point coordinate position during absolute position initial setting.
0: Position where the axis was stopped.
1: Grid point just before stopper.

【#2061】 OT_1B- Soft limit IB-

Set the coordinate of the lower limit of the area where the stored stroke limit IB is inhibited.
Set a value from zero point in the basic machine coordinate system.
If the same value (non-zero) with the same sign as that of "#2062 OT_1B+" is set, the stored stroke limit IB function will be disabled.

---Setting range---
-99999.999 to 99999.999 (mm)

【#2062】 OT_1B+ Soft limit IB+

Set the coordinate of the upper limit of the area where the stored stroke limit IB is inhibited.
Set a value from zero point in the basic machine coordinate system.

---Setting range---
-99999.999 to 99999.999 (mm)

【#2063】 OT_1B type Soft limit IB type

Select the type that applies the settings of "#2062 OT_1B+" and "#2061 OT_1B-" in stored stroke limit I.

- 0: Soft limit IB
- 1: The settings are invalid
- 2: Soft limit IC
- 3: Soft limit is checked for the inclined axis control axis with the program coordinate system.

(Note) This is valid only for inclined axis' base axis and inclined axis.

【#2068】 G0fwdg G00 feed forward gain

Set a feed forward gain for G00 pre-interpolation acceleration/deceleration.
The larger the setting value, the shorter the positioning time during in-position checking.
If a machine vibration occurs, set the smaller value.

---Setting range---
0 to 200 (%)

【#2069】 Rcoeff Axis arc radius error correction coefficient

Set the percentage to increase or decrease the arc radius error correction amount for each axis.

---Setting range---
-100.0 to +100.0 (%)

【#2070(PR)】 div_RT Rotational axis division count

Set the number of divisions of one turn of the rotary axis under control.

(Example)

When "36" is set, one turn is supposed to be 36.000.

(Note 1) When "0" is set, the normal rotary axis (360.000 degrees for one turn) is assumed.

(Note 2) If this parameter is changed when the absolute position detection specification is used, absolute position data will be lost. Initialization must be performed again.

---Setting range---
0 to 999

【#2071】 s_axis Inclined axis selection (for L system only)

Select whether the axis is to be under the inclined-axis control or to be the base axis corresponding to the inclined axis.

- 0: Not to be under the inclined-axis control
- 1: Inclined axis
- 2: Base axis corresponding to inclined axis

(Note) Each of "1" and "2" values must be set for only one axis. If either value is set for two or more axes, inclined-axis control does not work.

【#2072】 rslimt Restart limit

Set the most minus (-) side position where restart search is possible.
 If the machine is positioned on the more minus (-) side than the set value in T-command restart mode, restart search in type 3 will be disabled.

---Setting range---
 -9999.999 to 9999.999 (mm)

【#2073】 zrn_dog Origin dog Random assignment device

Under the standard specifications, the origin dog signal is assigned to a fixed device. Set the input device in this parameter when it is desired to assign the origin dog signal to a position other than the fixed device.

(Note 1) This parameter is valid when "1" is set in "#1226 aux10/bit5".
 (Note 2) When this parameter is valid, do not set the existing device number. If the existing device number is set, an emergency stop will occur. However, no device number check will be performed for an axis to which the "near-point dog ignored" signal is input.

---Setting range---
 0000 to 02FF (HEX)

【#2074】 H/W_OT+ H/W OT+ Random assignment device

Under the standard specifications, the OT (+) signal is assigned to a fixed device. Set the input device in this parameter when it is desired to assign the OT (+) signal to a position other than the fixed device.

(Note 1) This parameter is valid when "1" is set in "#1226 aux10/bit5".
 (Note 2) When this parameter is valid, do not set the existing device number. If the existing device number is set, an emergency stop will occur. However, no device number check will be performed for an axis to which the "OT ignored" signal is input.

---Setting range---
 0000 to 02FF (HEX)

【#2075】 H/W_OT- H/W OT- Random assignment device

Under the standard specifications, the OT (-) signal is assigned to a fixed device. Set the input device in this parameter when it is desired to assign the OT (-) signal to a position other than the fixed device.

(Note 1) This parameter is valid when "1" is set in "#1226 aux10/bit5".
 (Note 2) When this parameter is valid, do not set the existing device number. If the existing device number is set, an emergency stop will occur. However, no device number check will be performed for an axis to which the "OT ignored" signal is input.

---Setting range---
 0000 to 02FF (HEX)

【#2076】 index_x Index table indexing axis

Select whether the axis is a normal axis or an index table indexing axis.
 0: Normal axis
 1: Index table indexing axis

(Note) This parameter is valid only for the NC axis. The parameter is invalid if set for the PLC axis.

【#2077】 G0inps G0 in-position width

Set the in-position width for G0.
 Between SV024 and this parameter, the parameter with a larger value will be applied.
 When "0" is set, this parameter will be invalid: only SV024 will be available.

---Setting range---
 0.000 to 99.999 (mm)

【#2078】 G1inps G1 in-position width

Set the in-position width for G1.
Between SV024 and this parameter, the parameter with a larger value will be applied.
When "0" is set, this parameter will be invalid: only SV024 will be available.

---Setting range---
0.000 to 99.999 (mm)

【#2079(PR)】 chcomp

Not used. Set to "0".

【#2080】 chwid Bottom dead center position width

Set the tolerance between the commanded stroke and actual stroke.
Compensation will be applied during chopping so that the result of ((command width - maximum stroke of top or bottom dead point)/ 2) will be within this tolerance.

---Setting range---
0 to 10.000 (mm)
The number of the digits after the decimal point differs depending on the setting and display unit ("1003 iunit).
Example) 0.00000 to 10.00000(mm) for #1003 D

【#2081】 chclsp Maximum chopping speed

Set the clamp speed in chopping operation.
When "0" is set, the clamp speed will be determined by "#2002 clamp".

---Setting range---
0 to 60000 (mm/min)

【#2082】 a_rstax Restart position return order

Set the No. for each axis in order from the 1st automatically returning axis to the restart position.
When "0" is set, the axis will not return.
Note that when "0" is set for all axes, all of the axes will return simultaneously.

---Setting range---
0 to 8

【#2084】 G60_ax Unidirectional positioning operation selection

Select how to operate the unidirectional positioning when the positioning command (G00) is issued.
0: Carry out unidirectional positioning according to the command and modal.
1: Carry out unidirectional positioning regardless of the command and modal.
Set "1" for the axis to carry out the unidirectional positioning at every positioning command, regardless of whether the unidirectional positioning command and modal are issued.

<Related parameters>
"#8209 G60 SHIFT" and "#2076 index_x"

【#2086】 exdcax External deceleration speed

Set the maximum feed rate for each axis when the external deceleration signal is ON.
This parameter is enabled when "#1239 set11/bit6 (External deceleration axis compliance valid)" is set to "1".

---Setting range---
1 to 1000000 (mm/min)

【#2087】 syncnt Synchronization/super-imposition control setting for each axis

Set the polarity of synchronous axis with respect to basic axis to the bit corresponding to each axis.
0: Polarity with respect to basic axis is positive
1: Polarity with respect to basic axis is negative

---Setting range---
0 to FF (hexadecimal)

【#2088】 bsax_sy Reference axis for synchronous control

Set the basic axis for synchronous control with the 2nd axis name (axname2). A numerical character cannot be set as the 1st character.

---Setting range---
Axis name

【#2089】 bsax_pl

Not used. Set to "0".

【#2090】 plrapid Rapid traverse rate for super-imposition control

Set the rapid traverse rate for superimposition control.
(Equivalent to "#2001 rapid Rapid traverse rate".)

---Setting range---
1 to 1000000 (mm/min)

【#2091】 plclamp Cutting feed clamp speed for super-imposition control

Set the cutting feed clamp speed for superimposition control.
(Equivalent to "#2002 clamp Cutting feed clamp speed".)

---Setting range---
1 to 1000000 (mm/min)

【#2092】 plG0tL G0 time constant for superimposition control (linear)

Set the G0 time constant (linear) for superimposition control.
(Equivalent to "#2004 G0tL G0 time constant (linear)".)

---Setting range---
1 to 4000 (ms)

【#2093】 plG0t1 G0 time constant for superimposition control (primary delay)

Set the G0 time constant (primary delay) for superimposition control.
(Equivalent to "#2005 G0t1 G0 time constant (primary delay)".)

---Setting range---
1 to 5000 (ms)

【#2094】 plG1tL G1 time constant for superimposition control (linear)

Set the G1 time constant (linear) for superimposition control.
(Equivalent to "#2007 G1tL G1 time constant (linear)".)

---Setting range---
1 to 4000 (ms)

【#2095】 plG1t1 G1 time constant for superimposition control (primary delay)

Set the G1 time constant (primary delay) for superimposition control.
(Equivalent to "#2008 G1t1 G1 time constant (primary delay)".)

---Setting range---
1 to 5000 (ms)

【#2096】 crncsp Minimum corner deceleration speed

Set the minimum clamp speed for corner deceleration in the high-accuracy control mode. Normally set "0".

(Note) This parameter is invalid during SSS control.

---Setting range---
0 to 1000000 (mm/min)

【#2097】 tlm12- Sub side tool setter - direction sensor

Set the sensor position (on sub side) in the (-) direction when using the tool setter on the sub spindle side.

(Note) In the case of the basic axis and inclined axis of the inclined axis specifications, set the position on the orthogonal coordinate.

---Setting range---

-99999.999 to 99999.999 (mm)

【#2098】 tlm12+ Sub side tool setter + direction sensor

Set the sensor position (on sub side) in (+) direction when using the tool setter on the sub spindle side.

(Note) In the case of the basic axis and inclined axis of the inclined axis specifications, set the position on the orthogonal coordinate.

---Setting range---

-99999.999 to 99999.999 (mm)

【#2100】 rpcax Rotary axis workpiece position compensation valid

Set the state of the compensation of the rotary axis workpiece position.

0: Disable

1: Enable

【#2102】 skip_tL Skip time constant linear

Set a linear control time constant for variable speed skip acceleration and deceleration.

The time constant will be enabled when LC (cutting feed with linear acceleration and deceleration) or "F" (soft acceleration/deceleration) is selected in "#2003 smgst Acceleration and deceleration modes".

---Setting range---

1 to 4000 (ms)

【#2103】 skip_t1 Skip time constant primary delay / Second-step time constant for soft acceleration/deceleration

Set a primary-delay time constant for variable speed skip acceleration and deceleration.

The time constant will be enabled when C1 (cutting feed with primary delay) or C3 (exponential acceleration and linear deceleration) is selected in "#2003 smgst Acceleration and deceleration modes". When the soft acceleration/deceleration is selected, the second-step time constant will be used.

---Setting range---

1 to 5000 (ms)

【#2106】 Index unit Indexing unit

Set the indexing unit to which the rotary axis can be positioned.

---Setting range---

0 to 360 (°)

【#2109】 Rapid (H-precision) Rapid traverse rate for high-accuracy control mode

Set the rapid traverse rate for each axis in the high-accuracy control mode. "#2001 rapid" will be used when "0" is set.

---Setting range---

0 to 1000000 (mm/min)

【#2110】 Clamp (H-precision) Cutting feed clamp speed for high-accuracy control mode

Set the cutting feed maximum speed for each axis in the high-accuracy control mode. "#2002 clamp" will be used when "0" is set.

---Setting range---

0 to 1000000 (mm/min)

【#2111】 Blf valid Quadrant protrusion compensation valid

Set whether to enable the quadrant protrusion compensation.

0: Disable

1: Enable

If either of "#2112 Blf motor inertia", "#2115 Blf motor stl trq" or "#2113 Blf visc friction" is set to "0", quadrant protrusion compensation will not work even if this parameter is set to "1".

【#2112】 Blf motor inertia Motor inertia

Set the motor inertia for quadrant protrusion compensation.

Refer to the servo manual and input the value appropriate for the motor.

---Setting range---

1 to 32000 (10^{-6} kgm²)

【#2113】 Blf visc friction Viscous friction

Set the viscous friction for quadrant protrusion compensation.

After setting the other parameters to the appropriate values, monitor the machine end and gradually adjust the value.

If this parameter setting is small, a recess will form on the inner side of the circle, and if large, a protrusion will form on the outer side of the circle. When the value is appropriate, a spike-shaped quadrant protrusion will form based on normal step-shaped backlash.

---Setting range---

1 to 32767 (1/16 Nm/(rad/s))

【#2114】 Blf fwdg Compensation FF gain

Set the feed forward gain for quadrant protrusion compensation.

After setting the other parameters to the appropriate values, monitor the machine end and gradually adjust the value.

If this parameter setting is small, a large quadrant protrusion will form, and if large, a recess will form on the inner side of the circle.

---Setting range---

0 to 1000 (%)

【#2115】 Blf motor stl trq Motor stall torque

Set the motor rated current for quadrant protrusion compensation.

Refer to the servo manual and input the value appropriate for the motor.

---Setting range---

1 to 16000 (1/256 Nm)

【#2118(PR)】 SscDrSel Speed monitor Door selection

Select a door group of the speed monitoring to which the axis belongs.

The correspondence between the door signals and bits are as follows.

bit0: Door 1 group

bit1: Door 2 group

bit2: Door 3 group

bit3: Door 4 group

Several door groups can be set.

* When "0000", the axis belongs to door 1 group.

(Note)The speed monitoring is enabled when "SV113/bitF=1".

The selected door group must be set when setting the synchronous control.

The spindle/C axis control enables the door selection in "#3071 SscDrSelSp" for the corresponding spindle.

【#2119】 OT_sl- Inclined axis soft limit -

Set the lower limit of the inclined axis movable range with the program coordinate system (orthogonal).

The setting value is specified with the basic machine coordinates.

When the same value as "#2120 OT_sl+" is set here, inclined axis soft limit will not be enabled.

---Setting range---

-99999.999 to 99999.999 (mm)

【#2120】 OT_sl+ Inclined axis soft limit +

Set the upper limit of the inclined axis movable range with the program coordinate system (orthogonal).

The setting value is specified with the basic machine coordinates.

When the same value as "#2119 OT_sl-" is set here, inclined axis soft limit will not be enabled.

---Setting range---

-99999.999 to 99999.999 (mm)

【#2139】 omrff_off OMR-FF invalid

Select whether to enable or temporarily disable the OMR-FF control when OMR-FF is valid.

0: Enable

1: Temporarily disable

When "1" is selected while OMR-FF is valid, OMR-FF can be temporarily disabled and conventional feed forward control can be applied instead.

【#2140(PR)】 Ssc Svof Filter Speed monitor Error detection time during servo OFF

Set the error detection time of command speed monitoring and feedback speed monitoring during servo OFF.

An alarm will occur if the time, for which the speed has been exceeding the safe speed or safe rotation speed, exceeds the error detection time set in this parameter.

If "0" is set, it will be handled as 200 (ms).

(Note) Speed monitoring is enabled with "SV113/bitF=1".

---Setting range---

0 to 9999 (ms)

【#2141】 chtL Chopping first-step time constant for soft acceleration and deceleration

Set the first-step time constant for the chopping axis when soft acceleration/deceleration is applied. Note that, however, there may be cases where actual time constant is shorter than the set time constant, because the time constant is automatically calculated according to the feedrate so that the acceleration rate during acceleration/deceleration (clamp speed/chopping time constant) will be constant.

When 0 is set, #2007 G1tL is enabled.

---Setting range---

0 to 4000 (ms)

【#2142】 cht1 Chopping second-step time constant for soft acceleration and deceleration

Set the second-step time constant for the chopping axis when soft acceleration/deceleration is applied.

Note that, however, there may be cases where actual time constant is shorter than the set time constant. Because the time constant is automatically calculated according to the feed rate so that the acceleration rate during acceleration/deceleration (clamp speed/chopping time constant) can be constant.

When 0 is set, #2008 G1t1 is enabled.

---Setting range---

0 to 4000 (ms)

【#2143】 polar

Not used. Set to "0".

【#2144】 baseps

Not used. Set to "0".

【#2146】 Bif_L1 Reference distance for position-dependent increasing-type backlash compensation 1

Set the distance for specifying the compensation change rate in position-dependent increasing-type backlash compensation.

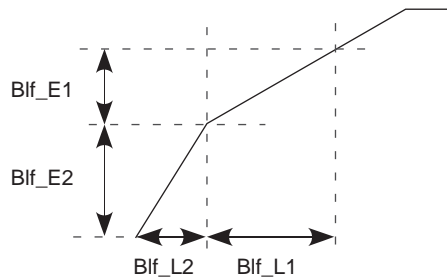

When "#2148 Bif_E1" is set to "0", the position-dependent increasing-type backlash compensation function will be disabled.

---Setting range---
0.000 to 99999.999 (mm)

【#2147】 Bif_L2 Reference distance for position-dependent increasing-type backlash compensation 2

Set the distance for specifying the compensation change rate in position-dependent increasing-type backlash compensation.

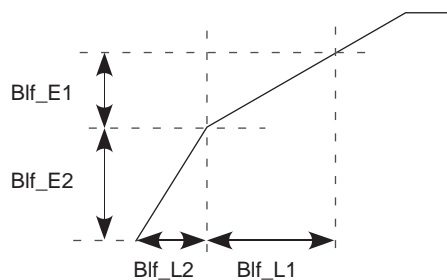

When "#2148 Bif_E1" is set to "0", the position-dependent increasing-type backlash compensation function will be disabled.

---Setting range---
0.000 to 99999.999 (mm)

【#2148】 Bif_E1 Reference amount of position-dependent increasing-type backlash compensation 1

Set the compensation amount for specifying the compensation change rate in position-dependent increasing-type backlash compensation.

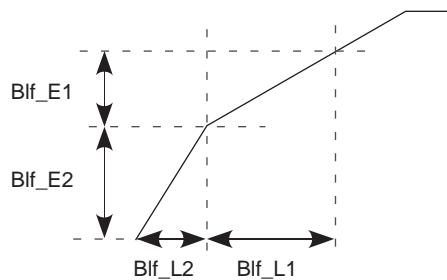

When "#2148 Bif_E1" is set to "0", the position-dependent increasing-type backlash compensation function will be disabled.

---Setting range---
0 to 9999999 (Machine error compensation unit)

【#2149】 Blf_E2 Reference amount of position-dependent increasing-type backlash compensation 2

Set the compensation amount for specifying the compensation change rate in position-dependent increasing-type backlash compensation.

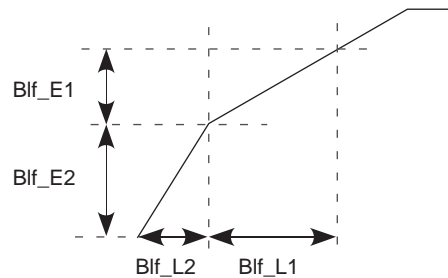

When "#2148 Blf_E1" is set to "0", the position-dependent increasing-type backlash compensation function will be disabled.

---Setting range---

0 to 9999999 (Machine error compensation unit)

【#2151】 rated_spd Rated speed

Set the maximum speed which can be driven with the motor's maximum torque.

* This parameter's setting value must be smaller than "#2001 rapid Rapid traverse". If bigger, constant inclination acceleration/deceleration will be applied.

* If rapid traverse constant inclination multi-step acceleration/deceleration is valid, and also if this parameter is set to "0", constant inclination acceleration/deceleration will be applied.

---Setting range---

0 to 1000000(mm/min)

【#2152】 acc_rate Acceleration rate in proportion to the maximum acceleration rate

Set the rate in proportion to the maximum acceleration rate in rapid traverse.

* If this parameter is set to "0" or "100", constant inclination acceleration/deceleration will be applied.

---Setting range---

0 to 100(%)

【#2153】 G0t_rated G0 time constant up to rated speed (multi-step acceleration/deceleration)

Set the acceleration rate up to the rated speed of rapid traverse constant inclination multi-step acceleration/deceleration.

(Note) If this parameter is set to "0", constant inclination acceleration/deceleration will be applied.

---Setting range---

0 to 4000(ms)

【#2155】 hob_fwd_g Feed forward gain for hobbing machining

Set the feed forward gain when controlling as workpiece axis of tool spindle synchronization II (hobbing).

---Setting range---

0 to 200 (%)

【#2156(PR)】 chopEnableAx Chopping command enabled axis

Set an axis for chopping axis.

0: Chopping command unacceptable axis

1: Chopping command acceptable axis

【#2157】 G1cF Optimum acceleration control Aimed speed

Set the speed to be aimed when calculating the tolerable acceleration between blocks.
 (Note) If tolerable acceleration is set to "0", the acceleration at rapid traverse is used as tolerable acceleration.

---Setting range---

1 to 999999 (mm/min)

【#2158】 G1cL Optimum acceleration control Time constant

Set the time constant for calculating the tolerable acceleration between blocks.

---Setting range---

1 to 5000 (ms)

【#2159】 G1cK Optimum acceleration control Accuracy coefficient

Set the accuracy coefficient for calculating the tolerable acceleration between blocks.

---Setting range---

0 to 99

【#2161】 exdcax1 External deceleration speed 1

Set the upper limit value of feedrate for each axis when the external deceleration signal is enabled and external deceleration speed 1 is selected.
 This parameter is valid when "#1239 set11/bit6" is set to "1".

---Setting range---

1 to 1000000 (mm/min)

【#2162】 exdcax2 External deceleration speed 2

Set the upper limit value of feedrate for each axis when the external deceleration signal is enabled and external deceleration speed 2 is selected.
 This parameter is valid when "#1239 set11/bit6" is set to "1".

---Setting range---

1 to 1000000 (mm/min)

【#2163】 exdcax3 External deceleration speed 3

Set the upper limit value of feedrate for each axis when the external deceleration signal is enabled and external deceleration speed 3 is selected.
 This parameter is valid when "#1239 set11/bit6" is set to "1".

---Setting range---

1 to 1000000 (mm/min)

【#2164】 exdcax4 External deceleration speed 4

Set the upper limit value of feedrate for each axis when the external deceleration signal is enabled and external deceleration speed 4 is selected.
 This parameter is valid when "#1239 set11/bit6" is set to "1".

---Setting range---

1 to 1000000 (mm/min)

【#2165】 exdcax5 External deceleration speed 5

Set the upper limit value of feedrate for each axis when the external deceleration signal is enabled and external deceleration speed 5 is selected.
 This parameter is valid when "#1239 set11/bit6" is set to "1".

---Setting range---

1 to 1000000 (mm/min)

【#2169】 Man meas rtn dir Return direction in manual measurement

Select the direction of return operation in manual measurement.
0: Opposite to the contact direction
1: Fixed to the + direction
2: Fixed to the - direction

【#2170】 Lmc1QR Lost motion compensation gain 1 for high-speed retract

Set the lost motion compensation gain in drilling cycle at high-speed retract (CW: - to + direction, CCW: + to - direction).
Set "-1" when drilling cycle at high-speed retract is not performed.
When set to 0, the performance will follow the setting of "#2171 Lmc2QR (Lost motion compensation gain 2 for high-speed retract)".

---Setting range---
-1, 0 to 200(%)

【#2171】 Lmc2QR Lost motion compensation gain 2 for high-speed retract

Set the lost motion compensation gain in drilling cycle at high-speed retract (CW: - to + direction, CCW: + to - direction).
Set "-1" when drilling cycle at high-speed retract is not performed.
When set to "0", the performance will follow the setting of "#2170 Lmc1QR (Lost motion compensation gain 1 for high-speed retract)".

---Setting range---
-1, 0 to 200(%)

【#2172】 LmcdQR Lost motion compensation timing for high-speed retract

Set the timing of the lost motion compensation in drilling cycle at high-speed retract.
When set to "0", the performance will follow the setting of "#2239 SV039 LMCD (Lost motion compensation timing)".

---Setting range---
0 to 2000 (ms)

【#2173】 LmckQR Lost motion compensation 3 spring constant for high-speed retract

Set the machine system's spring constant when using lost motion compensation type 3 in drilling cycle with high-speed retract.
When set to "0", the performance will follow the setting of "#2285 SV085 LMCK (Lost motion compensation 3 spring constant)".

---Setting range---
0 to 32767(0.01%/ μ m)

【#2174】 LmccQR Lost motion compensation 3 viscous coefficient for high-speed retract

Set the machine system's viscous coefficient when using lost motion compensation type 3 in drilling cycle at high-speed retract.
When set to "0", the performance will follow the setting of "#2286 SV086 LMCc (Lost motion compensation 3 viscous coefficient)".

---Setting range---
0 to 32767(0.01%/ μ m)

【#2177】 ManualFeedBtL Time constant for manual feed rate B

Set the acceleration/deceleration time constant for manual feed rate B.

(Note)When set to "0", this parameter will not be used: conventional acceleration/deceleration will be performed.

---Setting range---
0 to 20000 (ms)

【#2178】 DivOutAxNo Axis number designation parameter(axis type)

Designate a number of axis to output at the division output.
 -1: This axis is not to output.
 0: Output with the current number
 n: Output as n-th axis
 * The maximum "n" is 32.

---Setting range---
 -1 to 32

【#2180(PR)】 S_DIN Speed observation input door No.

Set the door signal input in the drive unit.
 Use this parameter only when the axis with a door signal belongs to several door groups.
 The correspondence between the door signals and bits are as follows.
 0000: No signal
 0001: Door 1 group.
 0002: Door 2 group.
 0004: Door 3 group.
 0008: Door 4 group.
 Set to "0" for an axis without door signal.
 When "0" is set even with door signal, follow #2118.
 Several bits can not be selected.
 A door signals set to #2118 can be set for #2118.

---Setting range---
 0000 to 0008 (HEX)

【#2181(PR)】 sscfeed1 Observation speed 1

Set the observation speed, which is at the machine end, in the multi-step speed monitor.
 (Note) When the setting value is larger than 18000, the last 2 digits will be ignored.
 Ex. 1234567 -> 1234500(mm/min, °/min)

---Setting range---
 0 to 6553500 (mm/min or °/min)

【#2182(PR)】 sscfeed2 Observation speed 2

Set the observation speed, which is at the machine end, in the multi-step speed monitor.
 (Note) When the setting value is larger than 18000, the last 2 digits will be ignored.
 Ex. 1234567 -> 1234500(mm/min, °/min)

---Setting range---
 0 to 6553500 (mm/min or °/min)

【#2183(PR)】 sscfeed3 Observation speed 3

Set the observation speed, which is at the machine end, in the multi-step speed monitor.
 (Note) When the setting value is larger than 18000, the last 2 digits will be ignored.
 Ex. 1234567 -> 1234500(mm/min, °/min)

---Setting range---
 0 to 6553500 (mm/min or °/min)

【#2184(PR)】 sscfeed4 Observation speed 4

Set the observation speed, which is at the machine end, in the multi-step speed monitor.
 (Note) When the setting value is larger than 18000, the last 2 digits will be ignored.
 Ex. 1234567 -> 1234500(mm/min, °/min)

---Setting range---
 0 to 6553500 (mm/min or °/min)

【#2185(PR)】 sscfeed5 Observation speed 5

Set the observation speed, which is at the machine end, in the multi-step speed monitor.

(Note) When the setting value is larger than 18000, the last 2 digits will be ignored.

Ex. 1234567 -> 1234500(mm/min, °/min)

---Setting range---

0 to 6553500 (mm/min or °/min)

【#2186(PR)】 sscfeed6 Observation speed 6

Set the observation speed, which is at the machine end, in the multi-step speed monitor.

(Note) When the setting value is larger than 18000, the last 2 digits will be ignored.

Ex. 1234567 -> 1234500(mm/min, °/min)

---Setting range---

0 to 6553500 (mm/min or °/min)

【#2188(PR)】 S_SigIn Safety observation signal input

This parameter specifies which safety observation signal is input in the drive unit.

Safety observation signal corresponds to the following parameter bits.

bit0: Connected to safety observation signal 1

bit1: Connected to safety observation signal 2

bit2: Connected to safety observation signal 3

Set "0000" for axes without inputting safety observation signal.

(Note) When a same set value is set for several axes and several bits can be enabled for an axis, the alarm "Y20 0027" occurs.

---Setting range---

0000 to 0004 (HEX)

【#2191(PR)】 sscfeed7 Observation speed 7

Set the observation speed, which is at the machine end, in the multi-step speed monitor.

(Note) When the setting value is larger than 18000, the last 2 digits will be ignored.

Ex. 1234567 -> 1234500(mm/min, °/min)

---Setting range---

0 to 6553500 (mm/min or °/min)

【#2192(PR)】 sscfeed8 Observation speed 8

Set the observation speed, which is at the machine end, in the multi-step speed monitor.

(Note) When the setting value is larger than 18000, the last 2 digits will be ignored.

Ex. 1234567 -> 1234500(mm/min, °/min)

---Setting range---

0 to 6553500 (mm/min or °/min)

【#2196(PR)】 sscSvSpec Safety observation specification selection

Select a specification of safety observation.

bit0: Constant speed observation

The speed observation is constantly enabled.

0: Speed observation is constantly disabled.

1: Speed observation is constantly enabled.

* Axes connected with Door1 to Door4 cannot be constantly observed.

(Setting error alarm for the parameter of constant speed observation)

【#2197(PR)】 sscCntFed Monitoring speed for constant speed monitor

Set the observation speed, which is at the machine end, in the multi-step speed monitor.

(Note) When the setting value is larger than 18000, the last 2 digits will be ignored.

Ex. 1234567 -> 1234500(mm/min, °/min)

---Setting range---

0 to 6553500 (mm/min or °/min)

【#2501】 svldmx Optimum time constant selection function valid/invalid

Select for each axis whether to enable the optimum time constant selection.
 0: Disable
 1: Enable

【#2502】 1-SVLD Servo load (Time constant data group 1)

Set the servo load so that the time constant data group 1 is to be selected during optimum time constant selection.

---Setting range---
 0 to 999

【#2503】 1-G0tL G00 time constant: Linear (Time constant data group 1)

Set G00 time constant (Linear: equivalent of "#2004 G0tL") in the time constant data group 1 for optimum time constant selection.

---Setting range---
 0 to 4000

【#2504】 1-G0t1 G00 time constant: Primary delay (Time constant data group 1)

Set G00 time constant (Primary delay: equivalent of "#2005 G0t1") in the time constant data group 1 for optimum time constant selection.

---Setting range---
 0 to 5000

【#2505】 1-G0t2 G00 time constant (Time constant data group 1)

Not used. Set to "0".

【#2506】 1-PGN1 Position loop gain1 (Time constant data group 1)

Set the position loop gain 1 (equivalent of "#2203 SV003 PGN1") in the time constant data group 1 for optimum time constant selection.

---Setting range---
 1 to 200

【#2507】 1-PGN2 Position loop gain 2 (Time constant data group 1)

Set the position loop gain 2 (equivalent of "#2204 SV004 PGN2") in the time constant data group 1 for optimum time constant selection.

---Setting range---
 0 to 999

【#2508】 1-HGCC High gain control constant (Time constant data group 1)

Set the high gain control constant (equivalent of "#2257 SV057 SHGC") in the time constant data group 1 for optimum time constant selection.

---Setting range---
 0 to 999

【#2514】 2-SVLD Servo load (Time constant data group 2)

Set the servo load so that the time constant data group 2 is to be selected during optimum time constant selection.

---Setting range---
 0 to 999

【#2515】 2-G0tL G00 time constant: Linear (Time constant data group 2)

Set G00 time constant (Linear: equivalent of "#2004 G0tL") in the time constant data group 2 for optimum time constant selection.

---Setting range---
0 to 4000

【#2516】 2-G0t1 G00 time constant: Primary delay (Time constant data group 2)

Set G00 time constant (Primary delay: equivalent of "#2005 G0t1") in the time constant data group 2 for optimum time constant selection.

---Setting range---
0 to 5000

【#2517】 2-G0t2 G00 time constant (Time constant data group 2)

Not used. Set to "0".

【#2518】 2-PGN1 Position loop gain1 (Time constant data group 2)

Set the position loop gain 1 (equivalent of "#2203 SV003 PGN1") in the time constant data group 2 for optimum time constant selection.

---Setting range---
0 to 200

【#2519】 2-PGN2 Position loop gain 2 (Time constant data group 2)

Set the position loop gain 2 (equivalent of "#2204 SV004 PGN2") in the time constant data group 2 for optimum time constant selection.

---Setting range---
0 to 999

【#2520】 2-HGCC High gain control constant (Time constant data group 2)

Set the high gain control constant (equivalent of "#2257 SV057 SHGC") in the time constant data group 2 for optimum time constant selection.

---Setting range---
0 to 999

【#2526】 3-SVLD Servo load (Time constant data group 3)

Set the servo load so that the time constant data group 3 is to be selected during optimum time constant selection.

---Setting range---
0 to 999

【#2527】 3-G0tL G00 time constant: Linear (Time constant data group 3)

Set G00 time constant (Linear: equivalent of "#2004 G0tL") in the time constant data group 3 for optimum time constant selection.

---Setting range---
0 to 4000

【#2528】 3-G0t1 G00 time constant: Primary delay (Time constant data group 3)

Set G00 time constant (Primary delay: equivalent of "#2005 G0t1") in the time constant data group 3 for optimum time constant selection.

---Setting range---
0 to 5000

【#2529】 3-G0t2 G00 time constant (Time constant data group 3)

Not used. Set to "0".

【#2530】 3-PGN1 Position loop gain1 (Time constant data group 3)

Set the position loop gain 1 (equivalent of "#2203 SV003 PGN1") in the time constant data group 3 for optimum time constant selection.

---Setting range---
0 to 200

【#2531】 3-PGN2 Position loop gain 2 (Time constant data group 3)

Set the position loop gain 2 (equivalent of "#2204 SV004 PGN2") in the time constant data group 3 for optimum time constant selection.

---Setting range---
0 to 999

【#2532】 3-HGCC High gain control constant (Time constant data group 3)

Set the high gain control constant (equivalent of "#2257 SV057 SHGC") in the time constant data group 3 for optimum time constant selection.

---Setting range---
0 to 999

【#2538】 4-SVLD Servo load (Time constant data group 4)

Set the servo load so that the time constant data group 4 is to be selected during optimum time constant selection.

---Setting range---
0 to 999

【#2539】 4-G0tL G00 time constant: Linear (Time constant data group 4)

Set G00 time constant (Linear: equivalent of "#2004 G0tL") in the time constant data group 4 for optimum time constant selection.

---Setting range---
0 to 4000

【#2540】 4-G0t1 G00 time constant: Primary delay (Time constant data group 4)

Set G00 time constant (Primary delay: equivalent of "#2005 G0t1") in the time constant data group 4 for optimum time constant selection.

---Setting range---
0 to 5000

【#2541】 4-G0t2 G00 time constant (Time constant data group 4)

Not used. Set to "0".

【#2542】 4-PGN1 Position loop gain1 (Time constant data group 4)

Set the position loop gain 1 (equivalent of "#2203 SV003 PGN1") in the time constant data group 4 for optimum time constant selection.

---Setting range---
0 to 200

【#2543】 4-PGN2 Position loop gain 2 (Time constant data group 4)

Set the position loop gain 2 (equivalent of "#2204 SV004 PGN2") in the time constant data group 4 for optimum time constant selection.

---Setting range---
0 to 999

【#2544】 4-HGCC High gain control constant (Time constant data group 4)

Set the high gain control constant (equivalent of "#2257 SV057 SHGC") in the time constant data group 4 for optimum time constant selection.

---Setting range---
0 to 999

【#2550】 5-SVLD Servo load (Time constant data group 5)

Set the servo load so that the time constant data group 5 is to be selected during optimum time constant selection.

---Setting range---
0 to 999

【#2551】 5-G0tL G00 time constant: Linear (Time constant data group 5)

Set G00 time constant (Linear: equivalent of "#2004 G0tL") in the time constant data group 5 for optimum time constant selection.

---Setting range---
0 to 4000

【#2552】 5-G0t1 G00 time constant: Primary delay (Time constant data group 5)

Set G00 time constant (Primary delay: equivalent of "#2005 G0t1") in the time constant data group 5 for optimum time constant selection.

---Setting range---
0 to 5000

【#2553】 5-G0t2 G00 time constant (Time constant data group 5)

Not used. Set to "0".

【#2554】 5-PGN1 Position loop gain1 (Time constant data group 5)

Set the position loop gain 1 (equivalent of "#2203 SV003 PGN1") in the time constant data group 5 for optimum time constant selection.

---Setting range---
0 to 200

【#2555】 5-PGN2 Position loop gain 2 (Time constant data group 5)

Set the position loop gain 2 (equivalent of "#2204 SV004 PGN2") in the time constant data group 5 for optimum time constant selection.

---Setting range---
0 to 999

【#2556】 5-HGCC High gain control constant (Time constant data group 5)

Set the high gain control constant (equivalent of "#2257 SV057 SHGC") in the time constant data group 5 for optimum time constant selection.

---Setting range---
0 to 999

【#2580(PR)】 index_Gcmd Index axis G command check

Check the commanded G cord for the index axis of index table.
0: No check
1: Prohibit the G command for cutting feed

【#2585】 Cyccmp Cyclic compensation

Select whether to validate the cyclic error compensation.
0 : Invalid
1 : Valid

【#2586】 Cystnum Compensation start No.

Set the compensation data start No.

The No. of compensation data as division number "#2587 Cycdv" will be used starting from this No.

---Setting range---

When machine error compensation point extension option is disabled: 4101 to 5124

When machine error compensation point extension option is enabled : 4101 to 5508

【#2587】 Cycdv Division No.

Designate a division No. per cycle set in "#2588 Cycct".

---Setting range----

1 to 128

【#2588】 Ccct Cycle constant

Set the No. of error cycle per rotation.

---Setting range---

0 to 32767

【#2592】 Extstnum Start number of compensation for external machine coordinates

Set the start number of compensation data.

From this number, use the compensation data from the number of external machine coordinates compensation sets "#2593 Extset" in order.

---Setting range---

4101 to 5508

【#2593】 Extset Number of external machine coordinates compensation sets

Set the number of sets of the compensation data.

The compensation is disabled with "0".

---Setting range---

0 to 32

【#2594】 Extsc Compensation scale of external machine coordinates

Set the number of sets of the compensation data.

The compensation is disabled with "0".

---Setting range---

0 to 99

【#2597】 retract_axis Unintended axis for tool retract and return

Select whether to intend the axis set this parameter for the tool retract and return 2 under the tool retract and return 2.

0: Intend

1: Not intend

【#2614(PR)】 JH_smgSel Jog/handle acceleration/deceleration selection

Switch jog/handle time constants and acceleration/deceleration. Set per axis.

0: Disable

1: Enable

【#2615(PR) JHsmgst Jog/handle acceleration/deceleration mode

Set acceleration/deceleration control modes.
The set value is in hexadecimal.

F	E	D	C	B	A	9	8	7	6	5	4	3	2	1	0
												J3		J1	LJ

J3: Exponential acceleration and linear deceleration

J1: Primary delay

L1: Linear acceleration/deceleration

(Note) Make sure to set a 0 in blank bits.

(Except bit2 when soft acceleration/deceleration is selected.)

Rapid traverse acceleration/deceleration type

0(bit3,2,1,0 = 0000) : Step

1(bit3,2,1,0 = 0001) : Linear acceleration/deceleration

2(bit3,2,1,0 = 0010) : Primary delay

8(bit3,2,1,0 = 1000) : Exponential acceleration and linear deceleration

F(bit3,2,1,0 = 1111) : Soft acceleration/deceleration

(Note) When J1 and J3 are set to "1", the primary delay is applied because of the priority of J1's setting.

【#2616] JHtL Jog/handle time constant (liner)

Set a liner time constant for jog feed/handle feed.

The time constant is enabled when linear acceleration/deceleration or "F" (soft acceleration/deceleration) is selected in "#2615 JHsmgst jog/handle acceleration and deceleration modes".

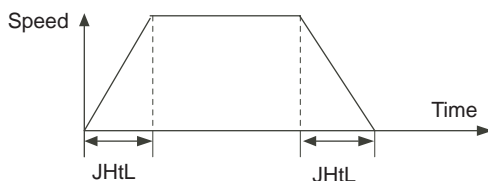

---Setting range---

1 to 4000 (ms)

【#2617】 JHt1 Jog/handle time constant(primary delay) / Second-step time constant for soft acceleration/deceleration

Set a primary-delay time constant for jog/handle feed acceleration/deceleration. The time constant is enabled when the primary delay or, exponential acceleration and linear deceleration is selected in "#2615 JHsmgst jog/handle acceleration and deceleration modes". When the soft acceleration/deceleration is selected, the second-step time constant is used.

<Jog/handle feed with primary delay>

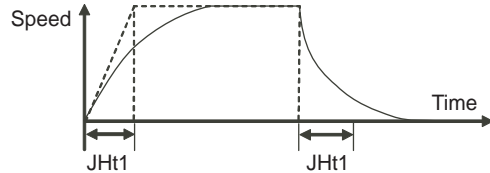

<Jog/handle feed with exponential acceleration and linear deceleration>

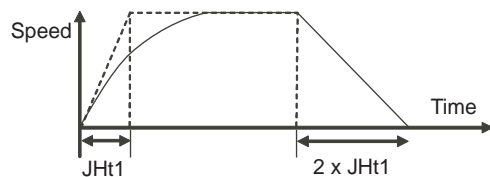

<Soft acceleration/deceleration>

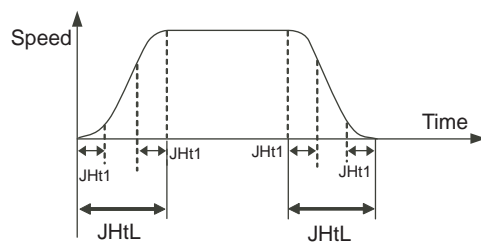

---Setting range---
1 to 5000 (ms)

【#2801】 P1-rap Parameter group 1: Rapid traverse rate

Set the rapid traverse rate (corresponding to #2001 rapid) for heavy workpiece parameter group 1 in optimum acceleration/deceleration selection.

---Setting range---
1 to 1000000 (mm/min)

【#2802】 P1-clp Parameter group 1: Cutting feed clamp feedrate

Set the cutting feed clamp feedrate (corresponding to #2002 clamp) for heavy workpiece parameter group 1 in optimum acceleration/deceleration selection.

---Setting range---
1 to 1000000 (mm/min)

【#2803】 P1-G0tL Parameter group 1: G0 time constant: Linear

Set the G0 time constant (corresponding to Linear: #2004 G0tL) for heavy workpiece parameter group 1 in optimum acceleration/deceleration selection.

---Setting range---
1 to 4000 (ms)

【#2804】 P1-G0t1 Parameter group 1: G0 time constant: primary delay

Set the G0 time constant (corresponding to primary delay: #2005 G0t1) for heavy workpiece parameter group 1 in optimum acceleration/deceleration selection.

---Setting range---
1 to 5000 (ms)

【#2805】 P1-G0t2 Parameter group 1: G0 time constant 2

Set the G0 time constant 2 (corresponding to #2006 G0t2) for heavy workpiece parameter group 1 in optimum acceleration/deceleration selection.

---Setting range---
0

【#2806】 P1-G1tL Parameter group 1: G1 time constant: Linear

Set the G1 time constant (corresponding to Linear: #2007 G1tL) for heavy workpiece parameter group 1 in optimum acceleration/deceleration selection.

---Setting range---
1 to 4000 (ms)

【#2807】 P1-G1t1 Parameter group 1: G1 time constant: Primary delay

Set the G1 time constant (corresponding to #2008 G1t1) for heavy workpiece parameter group 1 in optimum acceleration/deceleration selection.

---Setting range---
1 to 5000 (ms)

【#2808】 P1-G1t2 Parameter group 1: G1 time constant 2

Set the G1 time constant 2 (corresponding to #2009 G1t2) for heavy workpiece parameter group 1 in optimum acceleration/deceleration selection.

---Setting range---
0

【#2809】 P1-ffg0 Parameter group 1: G00 feed forward gain

Set the G00 feed forward gain (corresponding to #2068 G0fwdg) for heavy workpiece parameter group 1 in optimum acceleration/deceleration selection.

---Setting range---
0 to 200 (%)

【#2810】 P1-ffg1 Parameter group 1: Feed forward gain

Set the feed forward gain (corresponding to #2010 fwd_g) for heavy workpiece parameter group 1 in optimum acceleration/deceleration selection.

---Setting range---
0 to 200 (%)

【#2811】 P1-tapg Parameter group 1: Axis servo gain

Set the axis servo gain (corresponding to #2017 tap_g) for heavy workpiece parameter group 1 in optimum acceleration/deceleration selection.

---Setting range---
0.25 to 200.00 (rad/s)

【#2812】 P1-cF Parameter group 1: Optimum acceleration/deceleration control aimed speed

Set the optimum acceleration/deceleration control aimed speed (corresponding to #2157 G1cF) for heavy workpiece parameter group 1 in optimum acceleration/deceleration selection.

---Setting range---
1 to 999999 (mm/min)

【#2813】 P1-ctL Parameter group 1: Optimum acceleration/deceleration control time

Set the optimum acceleration/deceleration control time constant (corresponding to #2158 G1ctL) for heavy workpiece parameter group 1 in optimum acceleration/deceleration selection.

---Setting range---
1 to 5000 (ms)

【#2817】 P1-PGN1 Parameter group 1: Position loop gain 1

Set the position loop gain 1 (corresponding to #2203 SV003) for heavy workpiece parameter group 1 in optimum acceleration/deceleration selection.

---Setting range---
1 to 200 (rad/s)

【#2818】 P1-PGN2 Parameter group 1: Position loop gain 2

Set the position loop gain 2 (corresponding to #2204 SV004) for heavy workpiece parameter group 1 in optimum acceleration/deceleration selection.

---Setting range---
0 to 999 (rad/s)

【#2819】 P1-VGN1 Parameter group 1: Speed loop gain

Set the speed loop gain (corresponding to #2205 SV005) for heavy workpiece parameter group 1 in optimum acceleration/deceleration selection.

---Setting range---
1 to 9999

【#2820】 P1-SSF2 Parameter group 1: Servo function selection 2 (Depth)

Set the servo function selection 2 (depth selection, corresponding to #2233 SV033) for heavy workpiece parameter group 1 in optimum acceleration/deceleration selection.

---Setting range---
Refer to #2233 SV033

【#2821】 P1-FHz1 Parameter group 1: Machinery resonance center frequency 1

Set the machinery resonance center frequency 1 (corresponding to #2238 SV038) for heavy workpiece parameter group 1 in optimum acceleration/deceleration selection.

---Setting range---
0 to 2250 (Hz)

【#2822】 P1- FHz2 Parameter group 1: Machinery resonance center frequency 2

Set the machinery resonance center frequency 2 (corresponding to #2246 SV046) for heavy workpiece parameter group 1 in optimum acceleration/deceleration selection.

---Setting range---
0 to 2250 (Hz)

【#2823】 P1-SHGC Parameter group 1: Position loop gain 3

Set the position loop gain 3 (corresponding to #2257 SV05) for heavy workpiece parameter group 1 in optimum acceleration/deceleration selection.

---Setting range---
0 to 1200 (rad/s)

【#2841】 P2-rap Parameter group 2: Rapid traverse rate

Set the rapid traverse rate (corresponding to #2001 rapid) for heavy workpiece Parameter group 2 in optimum acceleration/deceleration selection.

---Setting range---
1 to 1000000 (mm/min)

【#2842】 P2-clp Parameter group 2: Cutting feed clamp feedrate

Set the cutting feed clamp feedrate (corresponding to #2002 clamp) for heavy workpiece Parameter group 2 in optimum acceleration/deceleration selection.

---Setting range---
1 to 1000000 (mm/min)

【#2843】 P2-G0tL Parameter group 2: G0 time constant: Linear

Set the G0 time constant (corresponding to Linear: #2004 G0tL) for heavy workpiece Parameter group 2 in optimum acceleration/deceleration selection.

---Setting range---
1 to 4000 (ms)

【#2844】 P2-G0t1 Parameter group 2: G0 time constant: primary delay

Set the G0 time constant (corresponding to primary delay: #2005 G0t1) for heavy workpiece Parameter group 2 in optimum acceleration/deceleration selection.

---Setting range---
1 to 5000 (ms)

【#2845】 P2-G0t2 Parameter group 2: G0 time constant 2

Set the G0 time constant 2 (corresponding to #2006 G0t2) for heavy workpiece Parameter group 2 in optimum acceleration/deceleration selection.

---Setting range---
0

【#2846】 P2-G1tL Parameter group 2: G1 time constant: Linear

Set the G1 time constant (corresponding to Linear: #2007 G1tL) for heavy workpiece Parameter group 2 in optimum acceleration/deceleration selection.

---Setting range---
1 to 4000 (ms)

【#2847】 P2-G1t1 Parameter group 2: G1 time constant: Primary delay

Set the G1 time constant (corresponding to #2008 G1t1) for heavy workpiece Parameter group 2 in optimum acceleration/deceleration selection.

---Setting range---
1 to 5000 (ms)

【#2848】 P2-G1t2 Parameter group 2: G1 time constant 2

Set the G1 time constant 2 (corresponding to #2009 G1t2) for heavy workpiece Parameter group 2 in optimum acceleration/deceleration selection.

---Setting range---
0

【#2849】 P2-ffg0 Parameter group 2: G00 feed forward gain

Set the G00 feed forward gain (corresponding to #2068 G0fwdg) for heavy workpiece Parameter group 2 in optimum acceleration/deceleration selection.

---Setting range---
0 to 200 (%)

【#2850】 P2-ffg1 Parameter group 2: Feed forward gain

Set the feed forward gain (corresponding to #2010 fwd_g) for heavy workpiece Parameter group 2 in optimum acceleration/deceleration selection.

---Setting range---
0 to 200 (%)

【#2851】 P2-tapg Parameter group 2: Axis servo gain

Set the axis servo gain (corresponding to #2017 tap_g) for heavy workpiece Parameter group 2 in optimum acceleration/deceleration selection.

---Setting range---

0.25 to 200.00 (rad/s)

【#2852】 P2-cF Parameter group 2: Optimum acceleration/deceleration control aimed speed

Set the optimum acceleration/deceleration control aimed speed (corresponding to #2157 G1cF) for heavy workpiece Parameter group 2 in optimum acceleration/deceleration selection.

---Setting range---

1 to 999999 (mm/min)

【#2853】 P2-ctL Parameter group 2: Optimum acceleration/deceleration control time constant

Set the optimum acceleration/deceleration control time constant (corresponding to #2158 G1ctL) for heavy workpiece Parameter group 2 in optimum acceleration/deceleration selection.

---Setting range---

1 to 5000 (ms)

【#2857】 P2-PGN1 Parameter group 2: Position loop gain 1

Set the position loop gain 1 (corresponding to #2203 SV003) for heavy workpiece Parameter group 2 in optimum acceleration/deceleration selection.

---Setting range---

1 to 200 (rad/s)

【#2858】 P2-PGN2 Parameter group 2: Position loop gain 2

Set the position loop gain 2 (corresponding to #2204 SV004) for heavy workpiece Parameter group 2 in optimum acceleration/deceleration selection.

---Setting range---

0 to 999 (rad/s)

【#2859】 P2-VGN1 Parameter group 2: Speed loop gain

Set the speed loop gain (corresponding to #2205 SV005) for heavy workpiece Parameter group 2 in optimum acceleration/deceleration selection.

---Setting range---

1 to 9999

【#2860】 P2-SSF2 Parameter group 2: Servo function selection 2 (Depth)

Set the servo function selection 2 (depth selection, corresponding to #2233 SV033) for heavy workpiece Parameter group 2 in optimum acceleration/deceleration selection.

---Setting range---

Refer to #2233 SV033

【#2861】 P2-FHz1 Parameter group 2: Machinery resonance center frequency 1

Set the machinery resonance center frequency 1 (corresponding to #2238 SV038) for heavy workpiece Parameter group 2 in optimum acceleration/deceleration selection.

---Setting range---

0 to 2250 (Hz)

【#2862】 P2- FHz2 Parameter group 2: Machinery resonance center frequency 2

Set the machinery resonance center frequency 2 (corresponding to #2246 SV046) for heavy workpiece Parameter group 2 in optimum acceleration/deceleration selection.

---Setting range---

0 to 2250 (Hz)

【#2863】 P2-SHGC Parameter group 2: Position loop gain 3

Set the position loop gain 3 (corresponding to #2257 SV05) for heavy workpiece Parameter group 2 in optimum acceleration/deceleration selection.

---Setting range---
0 to 1200 (rad/s)

【#2881】 P3-rap Parameter group 3: Rapid traverse rate

Set the rapid traverse rate (corresponding to #2001 rapid) for heavy workpiece Parameter group 3 in optimum acceleration/deceleration selection.

---Setting range---
1 to 1000000 (mm/min)

【#2882】 P3-clp Parameter group 3: Cutting feed clamp feedrate

Set the cutting feed clamp feedrate (corresponding to #2002 clamp) for heavy workpiece Parameter group 3 in optimum acceleration/deceleration selection.

---Setting range---
1 to 1000000 (mm/min)

【#2883】 P3-G0tL Parameter group 3: G0 time constant: Linear

Set the G0 time constant (corresponding to Linear: #2004 G0tL) for heavy workpiece Parameter group 3 in optimum acceleration/deceleration selection.

---Setting range---
1 to 4000 (ms)

【#2884】 P3-G0t1 Parameter group 3: G0 time constant: primary delay

Set the G0 time constant (corresponding to primary delay: #2005 G0t1) for heavy workpiece Parameter group 3 in optimum acceleration/deceleration selection.

---Setting range---
1 to 5000 (ms)

【#2885】 P3-G0t2 Parameter group 3: G0 time constant 2

Set the G0 time constant 2 (corresponding to #2006 G0t2) for heavy workpiece Parameter group 3 in optimum acceleration/deceleration selection.

---Setting range---
0

【#2886】 P3-G1tL Parameter group 3: G1 time constant: Linear

Set the G1 time constant (corresponding to Linear: #2007 G1tL) for heavy workpiece Parameter group 3 in optimum acceleration/deceleration selection.

---Setting range---
1 to 4000 (ms)

【#2887】 P3-G1t1 Parameter group 3: G1 time constant: Primary delay

Set the G1 time constant (corresponding to #2008 G1t1) for heavy workpiece Parameter group 3 in optimum acceleration/deceleration selection.

---Setting range---
1 to 5000 (ms)

【#2888】 P3-G1t2 Parameter group 3: G1 time constant 2

Set the G1 time constant 2 (corresponding to #2009 G1t2) for heavy workpiece Parameter group 3 in optimum acceleration/deceleration selection.

---Setting range---
0

【#2889】 P3-ffg0 Parameter group 3: G00 feed forward gain

Set the G00 feed forward gain (corresponding to #2068 G0fwdg) for heavy workpiece Parameter group 3 in optimum acceleration/deceleration selection.

---Setting range---
0 to 200 (%)

【#2890】 P3-ffg1 Parameter group 3: Feed forward gain

Set the feed forward gain (corresponding to #2010 fwd_g) for heavy workpiece Parameter group 3 in optimum acceleration/deceleration selection.

---Setting range---
0 to 200 (%)

【#2891】 P3-tapg Parameter group 3: Axis servo gain

Set the axis servo gain (corresponding to #2017 tap_g) for heavy workpiece Parameter group 3 in optimum acceleration/deceleration selection.

---Setting range---
0.25 to 200.00 (rad/s)

【#2892】 P3-cF Parameter group 3: Optimum acceleration/deceleration control aimed speed

Set the optimum acceleration/deceleration control aimed speed (corresponding to #2157 G1cF) for heavy workpiece Parameter group 3 in optimum acceleration/deceleration selection.

---Setting range---
1 to 999999 (mm/min)

【#2893】 P3-ctL Parameter group 3: Optimum acceleration/deceleration control time constant

Set the optimum acceleration/deceleration control time constant (corresponding to #2158 G1ctL) for heavy workpiece Parameter group 3 in optimum acceleration/deceleration selection.

---Setting range---
1 to 5000 (ms)

【#2897】 P3-PGN1 Parameter group 3: Position loop gain 1

Set the position loop gain 1 (corresponding to #2203 SV003) for heavy workpiece Parameter group 3 in optimum acceleration/deceleration selection.

---Setting range---
1 to 200 (rad/s)

【#2898】 P3-PGN2 Parameter group 3: Position loop gain 2

Set the position loop gain 2 (corresponding to #2204 SV004) for heavy workpiece Parameter group 3 in optimum acceleration/deceleration selection.

---Setting range---
0 to 999 (rad/s)

【#2899】 P3-VGN1 Parameter group 3: Speed loop gain

Set the speed loop gain (corresponding to #2205 SV005) for heavy workpiece Parameter group 3 in optimum acceleration/deceleration selection.

---Setting range---
1 to 9999

【#2900】 P3-SSF2 Parameter group 3: Servo function selection 2 (Depth)

Set the servo function selection 2 (depth selection, corresponding to #2233 SV033) for heavy workpiece Parameter group 3 in optimum acceleration/deceleration selection.

---Setting range---
Refer to #2233 SV033

【#2901】 P3-FHz1 Parameter group 3: Machinery resonance center frequency 1

Set the machinery resonance center frequency 1 (corresponding to #2238 SV038) for heavy workpiece Parameter group 3 in optimum acceleration/deceleration selection.

---Setting range---
0 to 2250 (Hz)

【#2902】 P3- FHz2 Parameter group 3: Machinery resonance center frequency 2

Set the machinery resonance center frequency 2 (corresponding to #2246 SV046) for heavy workpiece Parameter group 3 in optimum acceleration/deceleration selection.

---Setting range---
0 to 2250 (Hz)

【#2903】 P3-SHGC Parameter group 3: Position loop gain 3

Set the position loop gain 3 (corresponding to #2257 SV05) for heavy workpiece Parameter group 3 in optimum acceleration/deceleration selection.

---Setting range---
0 to 1200 (rad/s)

【#12400(PR)】 VaILMC Variable lost motion compensation valid

Set the state of the variable lost motion compensation.
0 : Disable
1 : Enable

【#12403】 LMC1ex_sc Variable lost motion compensation 1 magnification

Set the magnification for the variable lost motion compensation 1 (LMC1ex1 - LMC1ex8).
The effective value is "LMC1ex* × LMC1ex_sc/100".

---Setting range---
0 to 32767 (%)

【#12404】 LMC2ex_sc Variable lost motion compensation 2 magnification

Set the magnification for the variable lost motion compensation 2(LMC2ex1 - LMC2ex8).
The effective value is "LMC2ex* × LMC2ex_sc/100".

---Setting range---
0 to 32767 (%)

【#12405】 LMCkex_sc Variable lost motion compensation 3 magnification of spring constant

Set the magnification for the variable lost motion compensation 3 spring constant (LMCkex1 - LMCkex8).
The effective value is "LMCkex* × LMCkex_sc/100".

---Setting range---
0 to 32767 (%)

【#12406】 LMCcex_sc Variable lost motion compensation 3 magnification of viscose coefficient

Set the magnification for the variable lost motion compensation 3 viscose constant (LMCcex1 - LMCcex8).
The effective value is "LMCcex* × LMCcex_sc/100".

---Setting range---
0 to 32767 (%)

【#12419】 LMC1ex_sft Variable lost motion compensation 1 shift

Set the amount of shift for the variable lost motion compensation 1(LMC1ex1 - LMC1ex8).
The effective value is "LMC1ex* + LMC1ex_sft".

---Setting range---
-32768 to 32767 (Stall courant 0.01%)

【#12420】 LMC2ex_sft Variable lost motion compensation 2 shift

Set the amount of shift for the variable lost motion compensation 2(LMC2ex1 - LMC2ex8).
The effective value is "LMC2ex* + LMC2ex_sft".

---Setting range---

-32768 to 32767 (Stall current 0.01%)

【#12421】 LMCkex_sft Variable lost motion compensation 3 spring constant shift

Set the amount of shift for the variable lost motion compensation 3(LMCkex1 to LMCkex8).
The effective value is "LMCkex* × LMCkex_sft".

---Setting range---

-32768 to 32767 (0.01%/ μ m)

【#12422】 LMCcex_sft Variable lost motion compensation 3 viscose coefficient shift

Set the amount of shift for the variable lost motion compensation 3 viscose coefficient(LMCkex1 to LMCkex8).
The effective value is "LMCcex* + LMCcex_sft".

---Setting range---

-32768 to 32767 (0.01% · s/mm)

【#12433】 LMCa1 Variable lost motion selection acceleration

Set the acceleration for adjustment of variable lost motion parameter LMC1ex1 to LMCcex1.

---Setting range---

0 to 2147483647 (μ m/s²)

【#12435】 LMC1ex1 Variable lost motion compensation 1

Set this parameter when protrusions (caused by the non-sensitive band of friction, torsion, backlash, etc.) at quadrant change is too large. Set a compensation torque at the quadrant change (when an axis feed direction is reversed) by a proportion (%) to the stall current. Whether to enable the lost motion compensation and the method can be set with other parameters.

Type 3: When SV082(SSF5)/bit=1

Set the compensation torque equivalent of dynamic friction amount of the type 3 method compensation amount. The standard setting is double the dynamic friction torque.

Related parameters: LMC2ex1, SV082/bit1, LMCkex1, LMCcex1

To vary compensation amount according to the direction.

When LMC2ex is "0", compensate with the value of LMC1ex1 in both +/- directions.

Set this and LMC2ex1 to change the compensation amount depending on the command direction. (LMC1ex1: + direction, LMC2ex1: - direction. However, the directions may be opposite depending on other settings.)

When "-1" is set, the compensation is not performed in the direction of the command.

---Setting range---

-1 to 20000 (Stall current 0.01%)

【#12436】 LMC2ex1 Variable lost motion compensation 2

Set this parameter with LMC1ex1 to vary the lost motion compensation amount depending on the command directions.

Normally, set to "0".

Related parameter: LMC1ex1

---Setting range---

-1 to 20000 (Stall current 0.01%)

【#12437】 LMCkex1 Variable lost motion compensation 3 spring constant

Set the machine system's spring constant when using lost motion compensation type 3.
When not using, set to "0".

Related parameters: LMC1ex1, LMC2ex1, SV082/bit1, LMCcex1

---Setting range---

0 to 32767 (0.01%/μm)

【#12438】 LMCcex1 Variable lost motion compensation 3 viscose coefficient

Set the machine system's viscous coefficient when using lost motion compensation type 3.
When not using, set to "0".

Related parameter: LMC1ex1, LMC2ex1, SV082/bit1, LMCcex1

---Setting range---

0 to 32767 (0.01% · s/mm)

【#12449】 LMCa2 Variable lost motion selection acceleration

Set the acceleration for adjustment of variable lost motion parameter LMC1ex2 to LMCcex2.

---Setting range---

0 to 2147483647 (μm/s²)

【#12451】 LMC1ex2 Variable lost motion compensation 1

Set this parameter when protrusions (caused by the non-sensitive band of friction, torsion, backlash, etc.) at quadrant change is too large. Set a compensation torque at the quadrant change (when an axis feed direction is reversed.) by a proportion (%) to the stall current. Whether to enable the lost motion compensation and the method can be set with other parameters.

Type 3: When SV082(SSF5)/bit=1

Set the compensation torque equivalent of dynamic friction amount of the type 3 method compensation amount. The standard setting is double the dynamic friction torque.

Related parameters: LMC2ex2, SV082/bit1, LMCkex2, LMCcex2

To vary compensation amount according to the direction.

When LMC2ex2 is "0", compensate with the value of LMC1ex2 in both +/- directions.

Set this and LMC2ex2 to change the compensation amount depending on the command direction. (LMC1ex2: + direction, LMC2ex2: - direction. However, the directions may be opposite depending on other settings.)

When "-1" is set, the compensation is not performed in the direction of the command.

---Setting range---

-1 to 20000 (Stall current 0.01%)

【#12452】 LMC2ex2 Variable lost motion compensation 2

Set this parameter with LMC1ex2 to vary the lost motion compensation amount depending on the command directions.

Normally, set to "0".

Related parameter: LMC1ex2

---Setting range---

-1 to 20000 (Stall current 0.01%)

【#12453】 LMCkex2 Variable lost motion compensation 3 spring constant

Set the machine system's spring constant when using lost motion compensation type 3.
When not using, set to "0".

Related parameters: LMC1ex2, LMC2ex2, V082/bit1, LMCcex2

---Setting range---

0 to 32767 (0.01%/μm)

【#12454】 LMCcex2 Variable lost motion compensation 3 viscose coefficient

Set the machine system's viscous coefficient when using lost motion compensation type 3. When not using, set to "0".

Related parameter: LMC1ex2, LMC2ex2, SV082/bit1, LMCcex2

---Setting range---

0 to 32767 (0.01% · s/mm)

【#12465】 LMCa3 Variable lost motion selection acceleration

Set the acceleration for adjustment of variable lost motion parameter LMC1ex3 to LMCcex3.

---Setting range---

0 to 2147483647 (μ m/s²)

【#12467】 LMC1ex3 Variable lost motion compensation 1

Set this parameter when protrusions (caused by the non-sensitive band of friction, torsion, backlash, etc.) at quadrant change is too large. Set a compensation torque at the quadrant change (when an axis feed direction is reversed.) by a proportion (%) to the stall current. Whether to enable the lost motion compensation and the method can be set with other parameters.

Type 3: When SV082(SSF5)/bit=1

Set the compensation torque equivalent of dynamic friction amount of the type 3 method compensation amount. The standard setting is double the dynamic friction torque.

Related parameters: LMC2ex3, SV082/bit1, LMCkex3, LMCcex3

To vary compensation amount according to the direction.

When LMC2ex3 is "0", compensate with the value of LMC1ex3 in both +/- directions.

Set this and LMC2ex3 to change the compensation amount depending on the command direction. (LMC1ex3: + direction, LMC2ex3: - direction. However, the directions may be opposite depending on other settings.)

When "-1" is set, the compensation is not performed in the direction of the command.

---Setting range---

-1 to 20000 (Stall current 0.01%)

【#12468】 LMC2ex3 Variable lost motion compensation 2

Set this parameter with LMC1ex3 to vary the lost motion compensation amount depending on the command directions.

Normally, set to "0".

Related parameter: LMC1ex3

---Setting range---

-1 to 20000 (Stall current 0.01%)

【#12469】 LMCkex3 Variable lost motion compensation 3 spring constant

Set the machine system's spring constant when using lost motion compensation type 3. When not using, set to "0".

Related parameters: LMC1ex3, LMC2ex3, V082/bit1, LMCcex3

---Setting range---

0 to 32767 (0.01%/ μ m)

【#12470】 LMCcex3 Variable lost motion compensation 3 viscose coefficient

Set the machine system's viscous coefficient when using lost motion compensation type 3. When not using, set to "0".

Related parameter: LMC1ex3, LMC2ex3, SV082/bit1, LMCcex3

---Setting range---

0 to 32767 (0.01% · s/mm)

【#12481】 LMCa4 Variable lost motion selection acceleration

Set the acceleration for adjustment of variable lost motion parameter LMC1ex4 to LMCcex4.

---Setting range---

0 to 2147483647 ($\mu \text{ m/s}^2$)

【#12483】 LMC1ex4 Variable lost motion compensation 1

Set this parameter when protrusions (caused by the non-sensitive band of friction, torsion, backlash, etc.) at quadrant change is too large. Set a compensation torque at the quadrant change (when an axis feed direction is reversed.) by a proportion (%) to the stall current. Whether to enable the lost motion compensation and the method can be set with other parameters.

Type 3: When SV082(SSF5)/bit=1

Set the compensation torque equivalent of dynamic friction amount of the type 3 method compensation amount. The standard setting is double the dynamic friction torque.

Related parameters: LMC2ex4, SV082/bit1, LMCkex4, LMCcex4

To vary compensation amount according to the direction.

When LMC2ex4 is "0", compensate with the value of LMC1ex4 in both +/- directions.

Set this and LMC2ex4 to change the compensation amount depending on the command direction. (LMC1ex4: + direction, LMC2ex4: - direction. However, the directions may be opposite depending on other settings.)

When "-1" is set, the compensation is not performed in the direction of the command.

---Setting range---

-1 to 20000 (Stall current 0.01%)

【#12484】 LMC2ex4 Variable lost motion compensation 2

Set this parameter with LMC1ex4 to vary the lost motion compensation amount depending on the command directions.

Normally, set to "0".

Related parameter: LMC1ex4

---Setting range---

-1 to 20000 (Stall current 0.01%)

【#12485】 LMCkex4 Variable lost motion compensation 3 spring constant

Set the machine system's spring constant when using lost motion compensation type 3.

When not using, set to "0".

Related parameters: LMC1ex4, LMC2ex4, V082/bit1, LMCcex4

---Setting range---

0 to 32767 (0.01%/ $\mu \text{ m}$)

【#12486】 LMCcex4 Variable lost motion compensation 3 viscose coefficient

Set the machine system's viscous coefficient when using lost motion compensation type 3.

When not using, set to "0".

Related parameter: LMC1ex4, LMC2ex4, SV082/bit1, LMCcex4

---Setting range---

0 to 32767 (0.01% · s/mm)

【#12497】 LMCa5 Variable lost motion selection acceleration

Set the acceleration for adjustment of variable lost motion parameter LMC1ex5 to LMCcex5.

---Setting range---

0 to 2147483647 ($\mu \text{ m/s}^2$)

【#12499】 LMC1ex5 Variable lost motion compensation 1

Set this parameter when protrusions (caused by the non-sensitive band of friction, torsion, backlash, etc.) at quadrant change is too large. Set a compensation torque at the quadrant change (when an axis feed direction is reversed.) by a proportion (%) to the stall current. Whether to enable the lost motion compensation and the method can be set with other parameters.

Type 3: When SV082(SSF5)/bit=1

Set the compensation torque equivalent of dynamic friction amount of the type 3 method compensation amount. The standard setting is double the dynamic friction torque.

Related parameters: LMC2ex5, SV082/bit1, LMCkex5, LMCcex5

To vary compensation amount according to the direction.

When LMC2ex5 is "0", compensate with the value of LMC1ex5 in both +/- directions.

Set this and LMC2ex5 to change the compensation amount depending on the command direction. (LMC1ex5: + direction, LMC2ex5: - direction. However, the directions may be opposite depending on other settings.)

When "-1" is set, the compensation is not performed in the direction of the command.

---Setting range---

-1 to 20000 (Stall current 0.01%)

【#12500】 LMC2ex5 Variable lost motion compensation 2

Set this parameter with LMC1ex4 to vary the lost motion compensation amount depending on the command directions.

Normally, set to "0".

Related parameter: LMC1ex5

---Setting range---

-1 to 20000 (Stall current 0.01%)

【#12501】 LMCkex5 Variable lost motion compensation 3 spring constant

Set the machine system's spring constant when using lost motion compensation type 3.

When not using, set to "0".

Related parameters: LMC1ex5, LMC2ex5, V082/bit1, LMCcex5

---Setting range---

0 to 32767 (0.01%/μm)

【#12502】 LMCcex5 Variable lost motion compensation 3 viscose coefficient

Set the machine system's viscous coefficient when using lost motion compensation type 3.

When not using, set to "0".

Related parameter: LMC1ex5, LMC2ex5, SV082/bit1, LMCcex5

---Setting range---

0 to 32767 (0.01% · s/mm)

【#12513】 LMCa6 Variable lost motion selection acceleration

Set the acceleration for adjustment of variable lost motion parameter LMC1ex6 to LMCcex6.

---Setting range---

0 to 2147483647 (μm/s²)

【#12515】 LMC1ex6 Variable lost motion compensation 1

Set this parameter when protrusions (caused by the non-sensitive band of friction, torsion, backlash, etc.) at quadrant change is too large. Set a compensation torque at the quadrant change (when an axis feed direction is reversed.) by a proportion (%) to the stall current. Whether to enable the lost motion compensation and the method can be set with other parameters.

Type 3: When SV082(SSF5)/bit=1

Set the compensation torque equivalent of dynamic friction amount of the type 3 method compensation amount. The standard setting is double the dynamic friction torque.

Related parameters: LMC2ex6, SV082/bit1, LMCkex6, LMCcex6

To vary compensation amount according to the direction.

When LMC2ex6 is "0", compensate with the value of LMC1ex6 in both +/- directions.

Set this and LMC2ex6 to change the compensation amount depending on the command direction. (LMC1ex6: + direction, LMC2ex6: - direction. However, the directions may be opposite depending on other settings.)

When "-1" is set, the compensation is not performed in the direction of the command.

---Setting range---

-1 to 20000 (Stall current 0.01%)

【#12516】 LMC2ex6 Variable lost motion compensation 2

Set this parameter with LMC1ex4 to vary the lost motion compensation amount depending on the command directions.

Normally, set to "0".

Related parameter: LMC1ex6

---Setting range---

-1 to 20000 (Stall current 0.01%)

【#12517】 LMCkex6 Variable lost motion compensation 3 spring constant

Set the machine system's spring constant when using lost motion compensation type 3.

When not using, set to "0".

Related parameters: LMC1ex6, LMC2ex6, V082/bit1, LMCcex6

---Setting range---

0 to 32767 (0.01%/μm)

【#12518】 LMCcex6 Variable lost motion compensation 3 viscose coefficient

Set the machine system's viscous coefficient when using lost motion compensation type 3.

When not using, set to "0".

Related parameter: LMC1ex6, LMC2ex6, SV082/bit1, LMCcex6

---Setting range---

0 to 32767 (0.01% · s/mm)

【#12529】 LMCa7 Variable lost motion selection acceleration

Set the acceleration for adjustment of variable lost motion parameter LMC1ex7 to LMCcex7.

---Setting range---

0 to 2147483647 (μm/s²)

【#12531】 LMC1ex7 Variable lost motion compensation 1

Set this parameter when protrusions (caused by the non-sensitive band of friction, torsion, backlash, etc.) at quadrant change is too large. Set a compensation torque at the quadrant change (when an axis feed direction is reversed.) by a proportion (%) to the stall current. Whether to enable the lost motion compensation and the method can be set with other parameters.

Type 3: When SV082(SSF5)/bit=1

Set the compensation torque equivalent of dynamic friction amount of the type 3 method compensation amount. The standard setting is double the dynamic friction torque.

Related parameters: LMC2ex7, SV082/bit1, LMCkex7, LMCcex7

To vary compensation amount according to the direction.

When LMC2ex5 is "0", compensate with the value of LMC1ex7 in both +/- directions.

Set this and LMC2ex7 to change the compensation amount depending on the command direction. (LMC1ex7: + direction, LMC2ex7: - direction. However, the directions may be opposite depending on other settings.)

When "-1" is set, the compensation is not performed in the direction of the command.

---Setting range---

-1 to 20000 (Stall current 0.01%)

【#12532】 LMC2ex7 Variable lost motion compensation 2

Set this parameter with LMC1ex7 to vary the lost motion compensation amount depending on the command directions.

Normally, set to "0".

Related parameter: LMC1ex7

---Setting range---

-1 to 20000 (Stall current 0.01%)

【#12533】 LMCkex7 Variable lost motion compensation 3 spring constant

Set the machine system's spring constant when using lost motion compensation type 3.

When not using, set to "0".

Related parameters: LMC1ex7, LMC2ex7, V082/bit1, LMCcex7

---Setting range---

0 to 32767 (0.01%/μm)

【#12534】 LMCcex7 Variable lost motion compensation 3 viscose coefficient

Set the machine system's viscous coefficient when using lost motion compensation type 3.

When not using, set to "0".

Related parameter: LMC1ex7, LMC2ex7, SV082/bit1, LMCcex7

---Setting range---

0 to 32767 (0.01% · s/mm)

【#12545】 LMCa8 Variable lost motion selection acceleration

Set the acceleration for adjustment of variable lost motion parameter LMC1ex8 to LMCcex8.

---Setting range---

0 to 2147483647 (μm/s²)

【#12547】 LMC1ex8 Variable lost motion compensation 1

Set this parameter when protrusions (caused by the non-sensitive band of friction, torsion, backlash, etc.) at quadrant change is too large. Set a compensation torque at the quadrant change (when an axis feed direction is reversed.) by a proportion (%) to the stall current. Whether to enable the lost motion compensation and the method can be set with other parameters.

Type 3: When SV082(SSF5)/bit=1

Set the compensation torque equivalent of dynamic friction amount of the type 3 method compensation amount. The standard setting is double the dynamic friction torque.

Related parameters: LMC2ex8, SV082/bit1, LMCkex8, LMCcex8

To vary compensation amount according to the direction.

When LMC2ex8 is "0", compensate with the value of LMC1ex8 in both +/- directions.

Set this and LMC2ex8 to change the compensation amount depending on the command direction. (LMC1ex8: + direction, LMC2ex8: - direction. However, the directions may be opposite depending on other settings.)

When "-1" is set, the compensation is not performed in the direction of the command.

---Setting range---

-1 to 20000 (Stall current 0.01%)

【#12548】 LMC2ex8 Variable lost motion compensation 2

Set this parameter with LMC1ex8 to vary the lost motion compensation amount depending on the command directions.

Normally, set to "0".

Related parameter: LMC1ex8

---Setting range---

-1 to 20000 (Stall current 0.01%)

【#12549】 LMCkex8 Variable lost motion compensation 3 spring constant

Set the machine system's spring constant when using lost motion compensation type 3.

When not using, set to "0".

Related parameters: LMC1ex8, LMC2ex8, V082/bit1, LMCcex8

---Setting range---

0 to 32767 (0.01%/μm)

【#12550】 LMCcex8 Variable lost motion compensation 3 viscose coefficient

Set the machine system's viscous coefficient when using lost motion compensation type 3.

When not using, set to "0".

Related parameter: LMC1ex8, LMC2ex8, SV082/bit1, LMCcex8

---Setting range---

0 to 32767 (0.01% · s/mm)

2.5 Servo Parameters

The parameters with "(PR)" requires the CNC to be turned OFF after the settings. Turn the power OFF and ON to enable the parameter settings.

(Note) The parameter descriptions given here are intended for MDS-D2/DH2, MDS-DM2 and MDS-DJ Series.

If your drive system is MDS-D/DH, MDS-DM or MDS-D-SVJ3/SPJ3 Series, refer to the appropriate drive instruction manual. Some parameters have different specifications under these systems.

【#2201(PR)】 SV001 PC1 Motor side gear ratio

Set the gear ratio in the motor side when there is the gear between the servo motor's shaft and machine (ball screw, etc.).

For the rotary axis, set the total deceleration (acceleration) ratio.

Even if the gear ratio is within the setting range, the electronic gears may overflow and an initial parameter error (servo alarm 37) may occur.

For linear servo system
Set to "1".

---Setting range---

1 to 32767

【#2202(PR)】 SV002 PC2 Machine side gear ratio

Set the gear ratio in the machine side when there is the gear between the servo motor's shaft and machine (ball screw, etc.).

For the rotary axis, set the total deceleration (acceleration) ratio.

Even if the gear ratio is within the setting range, the electronic gears may overflow and an initial parameter error (servo alarm 37) may occur.

For linear servo system
Set to "1".

---Setting range---

1 to 32767

【#2203】 SV003 PGN1 Position loop gain 1

Set the position loop gain. The standard setting is "33".

The higher the setting value is, the more accurately the command can be followed, and the shorter the settling time in positioning gets, however, note that a bigger shock will be applied to the machine during acceleration/deceleration.

When using the SHG control, also set SV004 (PGN2) and SV057 (SHGC).

When using the OMR-FF control, set the servo rigidity against quadrant projection or cutting load, etc. For the tracking ability to the command, set by SV106(PGM).

---Setting range---

1 to 200 (rad/s)

【#2204】 SV004 PGN2 Position loop gain 2

When performing the SHG control, set the value of "SV003 x 8/3" to "SV004".

When not using the SHG control, set to "0".

When using the OMR-FF control, set to "0".

Related parameters: SV003, SV057

---Setting range---

0 to 999 (rad/s)

【#2205】 SV005 VGN1 Speed loop gain 1

Set the speed loop gain.

The higher the setting value is, the more accurate the control will be, however, vibration tends to occur.

If vibration occurs, adjust by lowering by 20 to 30%.

The value should be determined to the 70 to 80% of the value at which the vibration stops.

The value differs depending on servo motors.

Aim at the standard value determined by the servo motor type and load inertia ratio to adjust.

---Setting range---

1 to 30000

【#2206】 SV006 VGN2 Speed loop gain 2

Set the speed loop gain at the motor limitation speed VLMT (maximum rotation speed x 1.15) with "VCS(SV029: Speed at the change of speed loop gain)".

Use this to suppress noise at high speed rotation during rapid traverse, etc. Then, the speed loop gain decreases at faster speed than the setting value of VCS. When not using, set to "0".

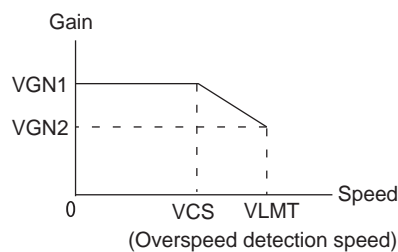

---Setting range---

-1000 to 30000

【#2207】 SV007 VIL Speed loop delay compensation

Set this when the limit cycle occurs in the full-closed loop, or overshooting occurs in positioning. The speed loop delay compensation method can be selected with SV027/bit1,0.

Normally, use "Changeover type 2". Changeover type 2 controls the occurrence of overshooting by lowering the speed loop lead compensation after the position droop gets 0.

When setting this parameter, make sure to set the torque offset (SV032).

---Setting range---

0 to 32767

【#2208】 SV008 VIA Speed loop lead compensation

Set the gain of the speed loop integral control.

Standard setting: 1364

Standard setting in the SHG control: 1900

Adjust the value by increasing/decreasing this by about 100 at a time.

Raise this value to improve contour tracking accuracy in high-speed cutting.

Lower this value when the position droop does not stabilize (when the vibration of 10 to 20Hz occurs).

---Setting range---

1 to 9999

【#2209】 SV009 IQA Current loop q axis lead compensation

Set the fixed value of each motor.

Set the standard value for each motor described in the standard parameter list.

---Setting range---

1 to 20480

【#2210】 SV010 IDA Current loop d axis lead compensation

Set the fixed value of each motor.
Set the standard value for each motor described in the standard parameter list.

---Setting range---
1 to 20480

【#2211】 SV011 IQG Current loop q axis gain

Set the fixed value of each motor.
Set the standard value for each motor described in the standard parameter list.

---Setting range---
1 to 8192

【#2212】 SV012 IDG Current loop d axis gain

Set the fixed value of each motor.
Set the standard value for each motor described in the standard parameter list.

---Setting range---
1 to 8192

【#2213】 SV013 ILMT Current limit value

Set the current (torque) limit value in a normal operation.
This is a limit value in forward run and reverse run (for linear motors:forward and reverse direction).
When the standard setting value is "800", the maximum torque is determined by the specification of the motor.
Set this parameter as a proportion (%) to the stall current.

---Setting range---
0 - 999 (Stall current %)

【#2214】 SV014 ILMTsp Current limit value in special control

Set the current (torque) limit value in a special operation (absolute position initial setting, stopper control and etc.).
This is a limit value in forward and reverse directions.
Set to "800" when not using.
Set this parameter as a proportion (%) to the stall current.

---Setting range---
0 - 999 (Stall current %)
However, when SV084/bitB=1, the setting range is from 0 to 32767 (Stall current 0.01%).

【#2215】 SV015 FFC Acceleration rate feed forward gain

When a relative error in synchronous control is too large, set this parameter to the axis that is delaying.
The standard setting is "0". The standard setting in the SHG control is "50".
To adjust a relative error in acceleration/deceleration, increase the value by 50 at a time.

---Setting range---
0 to 999 (%)

[#2216] SV016 LMC1 Lost motion compensation 1

Set this parameter when the protrusion (that occurs due to the non-sensitive band by friction, torsion, backlash, etc.) at quadrant change is too large. This sets the compensation torque at quadrant change (when an axis feed direction is reversed) by the proportion (%) to the stall torque. Whether to enable the lost motion compensation and the method can be set with other parameters.

Type 2: When SV027/bit9, 8=10 (Compatible with obsolete type)

Set the type 2 method compensation torque. The standard setting is double the friction torque.

Related parameters: SV027/bit9,8, SV033/bitF, SV039, SV040, SV041, SV082/bit2

Type 3: When SV082/bit1=1

Set the compensation torque equivalent of dynamic friction amount of the type 3 method compensation amount. The standard setting is double the dynamic friction torque.

Related parameters: SV041, SV082/bit2,1, SV085, SV086

To vary compensation amount according to the direction.

When SV041 (LMC2) is "0", compensate with the value of SV016 (LMC1) in both +/-directions.

If you wish to change the compensation amount depending on the command direction, set this and SV041 (LMC2).

(SV016: + direction, SV041: - direction. However, the directions may be opposite depending on other settings.)

When "-1" is set, the compensation will not be performed in the direction of the command.

---Setting range---

-1 to 200 (Stall current %)

Note that when SV082/bit2 is "1", the setting range is between -1 and 20000 (Stall current 0.01%).

【#2217(PR)】 SV017 SPEC1 Servo specification 1

Select the servo specifications.
 A function is allocated to each bit.
 Set this in hexadecimal format.

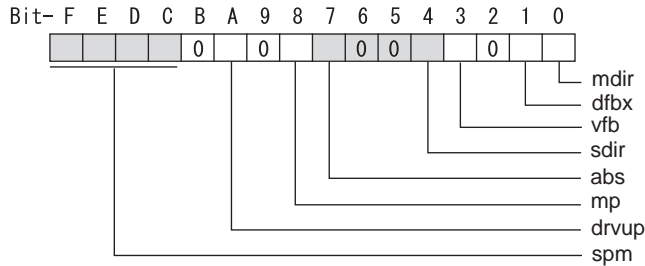

bit F-C : spm Motor series selection

- 0: Not used
- 1: 200V HF, HP motor (Standard)
- 2: Not used
- 3: 400V HF-H, HP-H motor (Standard)
- 6: 200V LM-F linear motor
- 7: 200V direct-drive motor
- 8: 400V LM-F linear motor
- 9: 400V direct-drive motor

bit B :

Not used. Set to "0".

bit A : drvup Combined drive unit:

- For MDS-DM2/D2-V3 Series
- 0: Normal setting (Combined drive unit: normal)
- 1: Combined drive unit: one upgrade

bit 9 :

Not used. Set to "0".

bit 8 : mp MPI scale pole number setting

- 0: 360 poles 1: 720 poles

bit 7 : abs Position control

These parameters are set automatically by the NC system.
 0: Incremental 1: Absolute position control

bit 6-5 :

Not used. Set to "0".

bit 4 : sdir Sub side detector feedback

Set the machine side detector's installation polarity.
 0: Forward polarity 1: Reverse polarity

bit 3 : vfb Speed feedback filter

- 0: Stop 1: Start (2250Hz)

bit 2 : seqh Ready on sequence

- 0: Normal 1: High-speed

bit 1 : dfbx Dual feedback control

Control the position FB signal in full closed control by the combination of a motor side detector and machine side detector.
 0: Stop 1: Start

Related parameters: SV051, SV052

bit 0 : mdir Machine side detector feedback (for Linear/direct-drive motor)

Set the detector installation polarity in the linear servo and direct-drive motor control.
 0: Forward polarity 1: Reverse polarity

[#2218(PR)] SV018 PIT Ball screw pitch/Magnetic pole pitch

For servo motor:

Set the ball screw pitch. For the rotary axis, set to "360".

For direct-drive motor

Set to "360".

For linear motor

Set the ball screw pitch. (For LM-F series, set to "48")

---Setting range---

For general motor: 1 to 32767 (mm/rev)

- For linear motor 1 to 32767 (mm)

 [#2219(PR)] SV019 RNG1 Sub side detector resolution

For semi-closed loop control

Set the same value as SV020.

For full-closed loop control

Set the number of pulses per ball screw pitch.

For direct-drive motor

Set the same value as SV020.

For 1000 pulse unit resolution detector, set the number of pulses in SV019 in increments of 1000 pulse (kp).

In this case, make sure to set "0" to SV117.

For high-accuracy binary resolution detector, set the number of pulses to four bite data of SV117 (high-order) and SV019 (low-order) in pulse (p) unit.

SV117 = number of pulses / 65536 (when =0, set "-1" to SV117)

SV019 = the remainder of number of "pulses / 65536"

When the NC is C70 and "SV019 > 32767", set "the remainder of above - 65536 (negative number)" to "SV019".

---Setting range---

When SV117 = 0, the setting range is from 0 to 32767 (kp)

When SV117 ≠ 0

For M700V, M70V, M70, E70: 0 to 65535 (p)

For C70: -32768 to 32767 (p)

 [#2220(PR)] SV020 RNG2 Main side detector resolution

Set the number of pulses per revolution of the motor side detector.

OSA18 (-A48) (260,000 p/rev) ----- SV020 = 260

OSA105 (-A51) (1,000,000 p/rev) ----- SV020 = 1000

OSA166 (-A74N) (16,000,000 p/rev) ----- SV020 = 16000

For linear motor

Set the number of pulses of the detector per magnetic pole pitch with SV118.

For direct-drive motor

Set the number of pulses per revolution of the motor side detector.

For 1000 pulse unit resolution detector, set the number of pulses to SV020 in increments of 1000 pulse(kp).

In this case, make sure to set SV118 to "0". For high-accuracy binary resolution detector, set the number of pulses to four bite data of SV118 (high-order) and SV020 (low-order) in pulse(p) unit.

SV118 = number of pulses / 65536 (when =0, set "-1" to SV118)

SV019 = the remainder of "number of pulses / 65536"

When the NC is C70 and "SV020 > 32767", set "the remainder of above - 65536 (negative number)" to "SV020".

---Setting range---

When SV118 = 0, the setting range is from 0 to 32767 (kp)

When SV118 ≠ 0

For M700V, M70V, M70, E70: 0 to 65535 (p)

For C70: -32768 to 32767 (p)

【#2221】 SV021 OLT Overload detection time constant

Normally, set to "60". (For machine tool builder adjustment.)

Related parameters: SV022

---Setting range---

1 to 999 (s)

【#2222】 SV022 OLL Overload detection level

Set the "Overload 1" (Alarm 50) current detection level as percentage to the stall current.
Normally set this parameter to "150". (For machine tool builder adjustment.)

Related parameters: SV021

---Setting range---

110 to 500 (Stall current %)

【#2223】 SV023 OD1 Excessive error detection width during servo ON

Set the excessive error detection width in servo ON.

When set to "0", the excessive error alarm detection will be ignored, so do not set to "0".

<Standard setting value>

$$OD1=OD2= (\text{Rapid traverse rate [mm/min]} / (60 \times \text{PGN1}) / 2 \text{ [mm]})$$

Related parameters: SV026

---Setting range---

0 to 32767 (mm)

However, when SV084/bitC=1, the setting range is from 0 to 32767 (μ m).

【#2224】 SV024 INP In-position detection width

Set the in-position detection width.

Set the positioning accuracy required for the machine.

The lower the setting is, the higher the positioning accuracy will be. However the cycle time (settling time) becomes longer.

The standard setting value is "50".

---Setting range---

0 to 32767 (μ m)

【#2225(PR)】 SV025 MTYP Motor/Detector type

Set the position detector type, speed detector type and motor type.
The setting value is a four-digit hex (HEX).

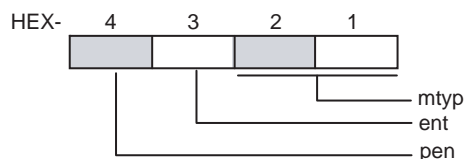
**bit F-C : pen(HEX-4) Position detector**

Semi-closed loop control by general motor
pen=2

Full-closed loop control by general motor

- Ball screw end detector (OSA105ET2A, OSA166ET2NA)
pen=6
- For serial signal output rotary scale (including MDS-B-HR)
pen=6
- For rectangular wave signal output scale
pen=8
- For serial signal output linear scale (including MDS-B-HR and MPI scale)
pen=A
- For speed command synchronization control
Primary axis pen=A
Secondary axis pen=D

For linear motor
pen=A

For direct-drive motor
pen=2

bit B-8 : ent(HEX-3) Speed detector

For general motor: ent=2
For linear motor: ent=A
For direct-drive motor: ent=2

bit 7-0 : mtyp(HEX-2,1) Motor type

Set the motor type. Set this with SV017/bitF-C.

For SV017/bitF-C = 1 (200V standard motor series)

HF75 : 01h	HP54 : 11h	HF-KP13 : E9h (Note 3)
HF105 : 02h	HP104 : 12h	HF-KP23 : EAh
HF54 : 03h	HP154 : 13h	HF-KP43 : EBh
HF104 : 04h	HP224 : 1Bh	HF-KP73 : ECh
HF154 : 05h, 0Fh (Note 1)	HP204 : 14h	
HF224 : 06h	HP354 : 15h	
HF204 : 07h	HP454 : 16h	
HF354 : 08h	HP704 : 17h	
HF123 : 24h	HP903 : 18h	
HF223 : 26h, 2Dh (Note 2)	HP1103 : 19h	
HF303 : 28h		
HF453 : 09h		
HF703 : 0Ah		
HF903 : 0Bh		
HF142 : 25h		
HF302 : 27h, 2Eh (Note 2)		

(Note 1) When MDS-D2-V3 is connected

(Note 2) When MDS-D2-V3 M/S axis is connected

(Note 3) MDS-DJ-V1/V2 only

For SV017/bitF-C = 3 (400V standard motor series)

HF-H75 : 01h,	HP-H54 : 11h
HF-H105 : 02h,	HP-H104 : 12h
HF-H54 : 03h,	HP-H154 : 13h
HF-H104 : 04h,	HP-H204 : 14h
HF-H154 : 05h,	HP-H354 : 15h
	HP-H454 : 16h
HF-H204 : 07h,	HP-H704 : 17h
HF-H354 : 08h,	HP-H903 : 18h
HF-H453 : 09h,	HP-H1103: 19h
HF-H703 : 0Ah	
HF-H903 : 0Bh,	HP-H224 : 1Bh
HC-H1502: B9h	

For linear motor and direct-drive motor, follow the settings stated in respective materials.

【#2226】 SV026 OD2 Excessive error detection width during servo OFF

Set the excessive error detection width during servo OFF.

When set to "0", the excessive error alarm detection will be ignored, so do not set to "0".

<Standard setting value>

$$OD1=OD2= (\text{Rapid traverse rate [mm/min]}) / (60 \times \text{PGN1}) / 2 \text{ [mm]}$$

Related parameters: SV023

---Setting range---

0 to 32767 (mm)

However, when SV084/bitC=1, the setting range is from 0 to 32767 (μm).

【#2227】 SV027 SSF1 Servo function 1

Select the servo functions.
A function is assigned to each bit.
Set this in hexadecimal format.

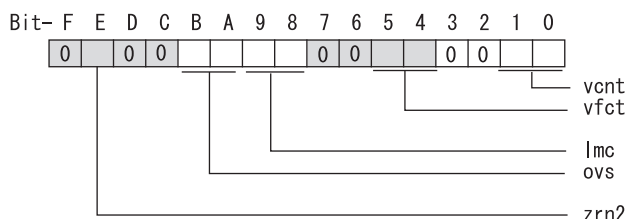
**bit F :**

Not used. Set to "0".

bit E : zrn2

Set to "1". (Fixed)

bit D :

Not used. Set to "0".

bit C :

Not used. Set to "0".

bit B-A : ovs Overshooting compensation

Set this if overshooting occurs during positioning.

bitB,A=

00: Compensation stop

01: Setting prohibited

10: Setting prohibited

11: Type 3

Set the compensation amount in SV031(OVS1) and SV042(OVS2).

Related parameters: SV031, SV042, SV034/bitF-C

bit 9-8 : lmc Lost motion compensation type

Set this parameter when the protrusion at quadrant change is too large.

Type 2 has an obsolete type compatible control.

bit9,8=

00: Compensation stop

01: Setting prohibited

10: Type 2

11: Setting prohibited

Set the compensation amount in SV016(LMC1) and SV041(LMC2).

(Note) When "SV082/bit1=1", the lost motion compensation type 3 will be selected regardless of this setting.

bit 7 :

Not used. Set to "0".

bit 6 :

Not used. Set to "0".

bit 5-4 : vfct Jitter compensation pulse number

Suppress vibration by machine backlash when axis stops.

bit5,4=

00: Disable

01: 1 pulse

10: 2 pulse

11: 3 pulses

bit 3 :

Not used. Set to "0".

bit 2 :

Not used. Set to "0".

bit 1-0 : vcnt Speed loop delay compensation changeover type selection

Normally, use "Changeover type 2".
 bit1,0=
 00: Disable
 01: Changeover type 1
 10: Changeover type 2
 11: Setting prohibited

Related parameters: SV007

【#2228(PR)】 SV028 MSFT Magnetic pole shift amount (for linear/direct-drive motor)

Set this parameter to adjust the motor magnetic pole position and detector's installation phase when using linear motors or direct-drive motors.
 During the DC excitation of the initial setup (SV034/bit4=1), set the same value displayed in "AFLT gain" on the NC monitor screen.

Related parameters: SV034/bit4, SV061, SV062, SV063

For general motor:
 Not used. Set to "0".

---Setting range---
 -18000 to 18000 (Mechanical angle 0.01°)

【#2229】 SV029 VCS Speed at the change of speed loop gain

Noise at high speed rotation including rapid traverse can be reduced by lowering the speed loop gain at high speeds.
 Set the speed at which the speed loop gain changes. Use this with SV006 (VGN2).
 When not using, set to "0".

---Setting range---
 0 to 9999 (r/min)

【#2230】 SV030 IVC Voltage non-sensitive band compensation

When 100% is set, the voltage reduction amount equivalent to the logical non-energization in the PWM control will be compensated.
 When "0" is set, 100% compensation will be performed.
 Adjust in increments of 10% from the default value of 100%.
 If increased too much, vibration or vibration noise may be generated.

---Setting range---
 0 to 255 (%)

【#2231】 SV031 OVS1 Overshooting compensation 1

This compensates the motor torque when overshooting occurs during positioning. This is valid only when the overshooting compensation (SV027/bitB,A) is selected.

Type 3 SV027/bitB,A=11

Set the compensation amount based on the motor stall current. Observing positioning droop waveform, increase in increments of 1% and find the value where overshooting does not occur.

To vary compensation amount depending on the direction.

When SV042 (OVS2) is "0", change the SV031 (OVS1) value in both of the +/- directions to compensate.

To vary the compensation amount depending on the command direction, set this and SV042 (OVS2).

(SV031: + direction, SV042: - direction. However, the directions may be opposite depending on other settings.)

When "-1" is set, the compensation will not be performed in the direction of the command.

Related parameters: SV027/bitB,A, SV034/bitF-C, SV042, SV082/bit2

---Setting range---
 -1 to 100 (Stall current %)
 Note that the range will be "-1 - 10000" (Stall current 0.01%) when SV082/bit2 is "1".

【#2232】 SV032 TOF Torque offset

Set the unbalance torque on vertical axis and inclined axis.

When the vertical axis pull up function is enabled, the pull up compensation direction is determined by this parameter's sign. When set to "0", the vertical axis pull up will not be executed.

This can be used for speed loop delay compensation and collision detection function.

To use load inertia estimation function (drive monitor display), set this parameter, friction torque (SV045) and load inertia display enabling flag(SV035/bitF).

Related parameters: SV007, SV033/bitE, SV059

---Setting range---

-100 to 100 (Stall current %)

[#2233] SV033 SSF2 Servo function 2

Select the servo functions.
 A function is assigned to each bit.
 Set this in hexadecimal format.

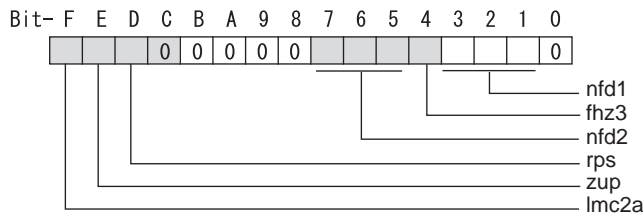

bit F : lmc2a Lost motion compensation 2 timing

0: Normal 1: Change

bit E : zup Vertical axis pull up function

0: Stop 1: Enable

Related parameters: SV032, SV095

bit D : rps Safely limited speed setting increment

Change the setting units of the specified speed signal output speed (SV073) and safely limited speed (SV238).

0: mm/min 1: 100mm/min

Related parameters: SV073, SV238

bit C-8 :

Not used. Set to "0".

bit 7-5 : nfd2 Depth of Notch filter 2

Set the depth of Notch filter 2 (SV046).

- bit7,6,5=
- 000: -∞
 - 001: -18.1[dB]
 - 010: -12.0[dB]
 - 011: -8.5[dB]
 - 100: -6.0[dB]
 - 101: -4.1[dB]
 - 110: -2.5[dB]
 - 111: -1.2[dB]

bit 4 : fhz3 Notch filter 3

0: Stop 1: Start (1,125Hz)

bit 3-1 : nfd1 Depth of Notch filter 1

Set the depth of Notch filter 1 (SV038).

- bit3,2,1=
- 000: -∞
 - 001: -18.1[dB]
 - 010: -12.0[dB]
 - 011: -8.5[dB]
 - 100: -6.0[dB]
 - 101: -4.1[dB]
 - 110: -2.5[dB]
 - 111: -1.2[dB]

bit 0 :

Not used. Set to "0".

[#2234] SV034 SSF3 Servo function 3

Select the servo functions.
A function is assigned to each bit.
Set this in hexadecimal format.

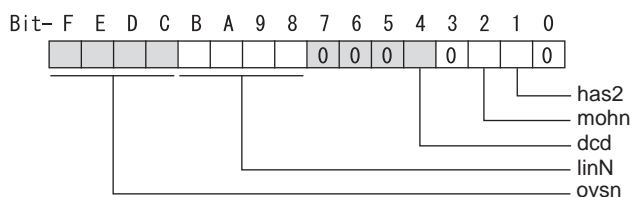
 **bit F-C: ovsn Overshooting compensation type 3 Non-sensitive band**

Set the non-sensitive band of the model position droop overshooting amount in increments of $2 \mu\text{m}$. In the feed forward control, set the non-sensitive band of the model position droop and ignore the overshooting of the model.

0 : $0 \mu\text{m}$, 1: $2 \mu\text{m}$, 2: $4 \mu\text{m}$,---, E : $28 \mu\text{m}$, F: $30 \mu\text{m}$

 bit B-8 : linN The number of parallel connections when using linear motors (for linear)

Set to "2" to perform 1 amplifier 2 motor control by linear servo.

 bit 7-5 :

Not used. Set to "0".

 bit 4 : dcd (linear/direct-drive motor)

0: Normal setting 1: DC excitation mode

Related parameters: SV061, SV062, SV063

 bit 3 :

Not used. Set to "0".

 bit 2 : mohn Thermistor temperature detection (linear/direct-drive motor)

0: Normal setting 1: Disable

 bit 1 : has HAS control

This stabilizes the speed overshooting by torque saturation phenomenon.

0: Normal setting 1: Enable

Related parameters: SV084/bitF

 bit 0 :

Not used. Set to "0".

【#2235】 SV035 SSF4 Servo function 4

Select the servo functions.
 A function is assigned to each bit.
 Set this in hexadecimal format.

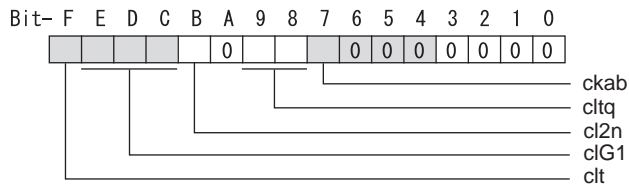

bit F : clt Inertia ratio display

0: Setting for normal use
 1: Display the total inertia ratio estimated at acceleration/deceleration at the inertia ratio on the servo monitor screen
 To display it on the screen, set an imbalance torque and friction torque to both SV032 and SV045 and repeat acceleration/deceleration operations for several times.

bit E-C: clG1 G1 Collision detection level

Set the collision detection level in the collision detection method 1 during cutting feed (G1) in multiples of that of rapid traverse (G0). When set to "0", detection of collision detection method 1 during cutting feed will be ignored.
 $G1 \text{ Collision detection level} = G0 \text{ collision detection level (SV060)} \times clG1$

bit B : cl2n Collision detection method 2

0: Enable 1: Disable

bit A :

Not used. Set to "0".

bit 9-8 : cltq Retract torque in collision detection

Set the retract torque in collision detection using the ratio of motor's maximum torque.
 bit9,8=
 00: 100%
 01: 90%
 10: 80%(Standard)
 11: 70%

bit 7 : ckab No signal detection 2

Set this to use rectangular wave output linear scale.
 This enables the detection of No signal 2 (alarm 21).
 0: Disable 1: Enable

bit 6-0 :

Not used. Set to "0".

【#2236(PR)】 SV036 PTPY Power supply type/ Regenerative resistor type**MDS-D2/DH2 Series: Power supply type**

When connecting a power supply unit, set a code for each power supply unit.

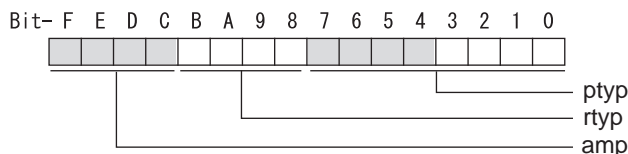
**bit F-C : amp**

Set the power backup function to be used.

No function used : 0

Deceleration and stop function at power failure : 8

bit B-8 : rtyp

Not used. Set to "0".

bit 7-0 : ptyp External emergency stop setting

When the emergency stop input signal of the power supply unit is "disabled"

Power supply unit is not connected : 00

MDS-D2-CV-37 / MDS-DH2-CV-37 : 04

MDS-D2-CV-75 / MDS-DH2-CV-75 : 08

MDS-D2-CV-110 / MDS-DH2-CV-110 : 11

MDS-D2-CV-185 / MDS-DH2-CV-185 : 19

MDS-D2-CV-300 / MDS-DH2-CV-300 : 30

MDS-D2-CV-370 / MDS-DH2-CV-370 : 37

MDS-D2-CV-450 / MDS-DH2-CV-450 : 45

MDS-D2-CV-550 / MDS-DH2-CV-550 : 55

MDS-DH2-CV-750 : 75

When the emergency stop input signal of the power supply unit is "enabled"

(Note) Set the power supply rotary switch to "4".

Power supply unit is not connected : 00

MDS-D2-CV-37 / MDS-DH2-CV-37 : 44

MDS-D2-CV-75 / MDS-DH2-CV-75 : 48

MDS-D2-CV-110 / MDS-DH2-CV-110 : 51

MDS-D2-CV-185 / MDS-DH2-CV-185 : 59

MDS-D2-CV-300 / MDS-DH2-CV-300 : 70

MDS-D2-CV-370 / MDS-DH2-CV-370 : 77

MDS-D2-CV-450 / MDS-DH2-CV-450 : 85

MDS-D2-CV-550 / MDS-DH2-CV-550 : 95

MDS-DH2-CV-750 : B5

MDS-DM2-SPV Series

Not used. Set to "0000".

External emergency stop power supply type is set by spindle parameter (SP032).

MDS-DJ-V1/V2 Series: Regenerative resistor type

Set the regenerative resistor type.

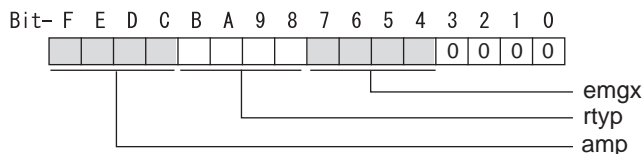

bit F-8 : amp(bit F-C) / rtyp(bit B-8)

Resistor built-in drive unit	: 10
Setting prohibited	: 11
MR-RB032	: 12
MR-RB12 or GZG200W39OHMK	: 13
MR-RB32 or GZG200W120OHMK 3 units connected in parallel	: 14
MR-RB30 or GZG200W39OHMK 3 units connected in parallel	: 15
MR-RB50 or GZG300W39OHMK 3 units connected in parallel	: 16
MR-RB31 or GZG200W20OHMK 3 units connected in parallel	: 17
MR-RB51 or GZG300W20OHMK 3 units connected in parallel	: 18
Setting prohibited	: 19-1F
Setting prohibited	: 20-23
FCUA-RB22	: 24
FCUA-RB37	: 25
FCUA-RB55	: 26
FCUA-RB75/2	: 27
Setting prohibited	: 28
R-UNIT2	: 29
Setting prohibited	: 2A-2C
FCUA-RB75/2 2 units connected in parallel	: 2D
FCUA-RB55 2 units connected in parallel	: 2E
Setting prohibited	: 2F

bit 7-4 : emgx External emergency stop function

Set the external emergency stop function.
0: Disable 4: Enable

bit 3-0 :

Not used. Set to "0".

【#2237】 SV037 JL Load inertia scale

Set the motor axis conversion total load inertia including motor itself in proportion to the motor inertia.

$$SV037(JL)=(Jm+Jl)/Jm \times 100$$

Jm: Motor inertia

Jl: Motor axis conversion load inertia

For linear motor, set the gross mass of the moving sections in kg unit.

<<Drive monitor load inertia ratio display>>

Set SV035/bitF=1 and imbalance torque and friction torque to both SV032 and SV045, and then repeat acceleration/deceleration for several times.

---Setting range---

For general motor: 0 to 5000 (%)

For linear motor 0 to 5000 (kg)

【#2238】 SV038 FHZ1 Notch filter frequency 1

Set the vibration frequency to suppress when machine vibration occurs.

(Normally, do not set 80 or less.)

Set to "0" when not using.

Related parameters: SV033/bit3-1, SV115

---Setting range---

0 to 2250 (Hz)

【#2239】 SV039 LMCD Lost motion compensation timing

Set this when the timing of lost motion compensation type 2 does not match.

Adjust increments of 10 at a time.

---Setting range---

0 to 2000 (ms)

【#2240】 SV040 LMCT Lost motion compensation non-sensitive band

Set the non-sensitive band of the lost motion compensation in the feed forward control.
When "0" is set, 2 μ m is the actual value to be set. Adjust increments of 1 μ m.

---Setting range---

0 to 255 (μ m)

【#2241】 SV041 LMC2 Lost motion compensation 2

Set this with SV016 (LMC1) only when you wish to vary the lost motion compensation amount depending on the command directions.
Normally, set to "0".

---Setting range---

-1 to 200 (Stall current %)

Note that when SV082/bit2 is "1", the setting range is between -1 and 20000 (Stall current 0.01%).

【#2242】 SV042 OVS2 Overshooting compensation 2

Set this with SV031 (OVS1) only when you wish to vary the overshooting compensation amount depending on the command directions.
Normally, set to "0".

---Setting range---

-1 to 100 (Stall current %)

Note that when SV082/bit2 is "1", the setting range is between -1 and 10000 (Stall current 0.01%).

【#2243】 SV043 OBS1 Disturbance observer filter frequency

Set the disturbance observer filter band.
Normally, set to "100". Setting values of 49 or less is equal to "0" setting.
To use the disturbance observer, also set SV037 (JL) and SV044 (OBS2).
When disturbance observer related parameters are changed, lost motion compensation needs to be readjusted.
Set to "0" when not using.

---Setting range---

0 to 1000 (rad/s)

【#2244】 SV044 OBS2 Disturbance observer gain

Set the disturbance observer gain. The standard setting is "100 to 300".
To use the disturbance observer, also set SV037 (JL) and SV043 (OBS1).
When disturbance observer related parameters are changed, lost motion compensation needs to be readjusted.
Set to "0" when not using.

---Setting range---

0 to 500 (%)

【#2245】 SV045 TRUB Friction torque

Set the frictional torque when using the collision detection function.
To use load inertia estimation function (drive monitor display), set this parameter, imbalance torque (SV032) and load inertia display enabling flag (SV035/bitF).

---Setting range---

0 to 255 (Stall current %)

【#2246】 SV046 FH2 Notch filter frequency 2

Set the vibration frequency to suppress when machine vibration occurs.
(Normally, do not set 80 or less.)
Set to "0" when not using.

Related parameters: SV033/bit7-5, SV115

---Setting range---

0 to 2250 (Hz)

【#2247】 SV047 EC Inductive voltage compensation gain

Set the inductive voltage compensation gain. Standard setting value is "100".
If the current FB peak exceeds the current command peak, lower the gain.

---Setting range---
0 to 200 (%)

【#2248】 SV048 EMGrT Vertical axis drop prevention time

Input the time required to prevent the vertical axis from dropping by delaying READY OFF until the brake works at an emergency stop.
Increase in increments of 100ms at a time, find and set the value where the axis does not drop.
When using a motor with a break of HF(-H) Series or HP(-H) Series, set to "200ms" as a standard.
When the pull up function is enabled (SV033/bitE=1), the pull up is established during the drop prevention time.

Related parameters: SV033/bitE, SV055, SV056

---Setting range---
0 to 20000 (ms)

【#2249】 SV049 PGN1sp Position loop gain 1 in spindle synchronous control

Set the position loop gain during spindle synchronization control (synchronous tapping and synchronization control with spindle C-axis).
Set the same value as that of the position loop gain for spindle synchronous tapping control.
When performing the SHG control, set this parameter with SV050 (PGN2sp) and SV058 (SHGCsp).
When changing the value, change the value of "#2017 tap_g Axis servo gain".

---Setting range---
1 to 200 (rad/s)

【#2250】 SV050 PGN2sp Position loop gain 2 in spindle synchronous control

When using SHG control during spindle synchronous control (synchronous tapping and synchronization control with spindle C-axis), set this parameter with SV049 (PGN1sp) and SV058 (SHGCsp).
Make sure to set the value 8/3 times that of SV049.
When not using the SHG control, set to "0".

---Setting range---
0 to 999 (rad/s)

【#2251】 SV051 DFBT Dual feedback control time constant

Set the control time constant in dual feed back.
When "0" is set, it operates at 1ms.
The higher the time constant is, the closer it gets to the semi-closed control, so the limit of the position loop gain will be raised.

For linear servo/direct-drive motor system
Not used. Set to "0".

Related parameters: SV017/bit1, SV052

---Setting range---
0 to 9999 (ms)

【#2252】 SV052 DFBN Dual feedback control non-sensitive band

Set the non-sensitive band in the dual feedback control.
Normally, set to "0".

For linear servo/direct-drive motor system
Not used. Set to "0".

Related parameters: SV017/bit1, SV052

---Setting range---
0 to 9999 (μ m)

【#2253】 SV053 OD3 Excessive error detection width in special control

Set the excessive error detection width when servo ON in a special control (initial absolute position setting, stopper control and etc.).

When "0" is set, excessive error detection will not be performed when servo ON during a special control.

---Setting range---

0 to 32767 (mm)

However, when SV084/bitC=1, the setting range is from 0 to 32767 (μ m).

【#2254】 SV054 ORE Overrun detection width in closed loop control

Set the overrun detection width in the full-closed loop control.

When the gap between the motor side detector and the linear scale (machine side detector) exceeds the value set by this parameter, it will be judged as overrun and "Alarm 43" will be detected.

When "-1" is set, if the differential velocity between the motor side detector and the machine side detector exceeds the 30% of the maximum motor speed, it will be judged as overrun and "Alarm 43" will be detected.

When "0" is set, overrun will be detected with a 2mm width.

For linear servo/direct-drive motor system

Not used. Set to "0".

---Setting range---

-1 to 32767 (mm)

However, when SV084/bitD=1, the setting range is from -1 to 32767 (μ m).

【#2255】 SV055 EMGx Max. gate off delay time after emergency stop

Set the time required between an emergency stop and forced READY OFF.

Set the maximum value "+ 100ms" of the SV056 setting value of the servo drive unit electrified by the same power supply unit.

When executing the vertical axis drop prevention, the gate off will be delayed for the length of time set at SV048 even when SV055's is smaller than that of SV048.

Related parameters: SV048, SV056

---Setting range---

0 to 20000 (ms)

【#2256】 SV056 EMGt Deceleration time constant at emergency stop

Set the time constant used for the deceleration control at emergency stop.

Set the time required to stop from rapid traverse rate (rapid).

The standard setting value is $EMGt \leq G0tL \times 0.9$.

However, note that the standard setting value differs from the above-mentioned value when the setting value of "#2003:smgst Acceleration and deceleration modes bit 3-0:Rapid traverse acceleration/deceleration type" is 8 or F. Refer to Instruction Manual of the drive unit (section "Deceleration Control") for details.

Related parameters: SV048, SV055

---Setting range---

0 to 20000 (ms)

【#2257】 SV057 SHGC SHG control gain

When performing the SHG control, set to SV003(PGN1) \times 6.

When not using the SHG control, set to "0".

When using the OMR-FF control, set to "0".

Related parameters: SV003, SV004

---Setting range---

0 to 1200 (rad/s)

【#2258】 SV058 SHGCsp SHG control gain in spindle synchronous control

When using SHG control during spindle synchronization control (synchronous tapping and synchronous control with spindle C-axis), set this parameter with SV049 (PGN1sp) and SV050 (PGN2sp).

Make sure to set the value 6 times that of SV049.

When not using the SHG control, set to "0".

---Setting range---

0 to 1200 (rad/s)

【#2259】 SV059 TCNV Collision detection torque estimated gain

Set the torque estimated gain when using the collision detection function.

The standard setting value is the same as the load inertia ratio (SV037 setting value) including motor inertia.

Set to "0" when not using the collision detection function.

Related parameters: SV032, SV035/bitF-8, SV037, SV045, SV060

<<Drive monitor load inertia ratio display>>

Set SV035/bitF=1 and imbalance torque and friction torque to both SV032 and SV045, and then repeat acceleration/deceleration for several times.

---Setting range---

For general motor: 0 to 5000 (%)

For linear motor: 0 to 5000 (kg)

【#2260】 SV060 TLMT Collision detection level

When using the collision detection function, set the collision detection level at the G0 feeding.

When "0" is set, none of the collision detection function will work.

Related parameters: SV032, SV035/bitF-8, SV037, SV045, SV059

---Setting range---

0 to 999 (Stall current %)

【#2261】 SV061 DA1NO D/A output ch1 data No. / Initial DC excitation level

Input the data number you wish to output to the D/A output channel 1.

When using the 2-axis drive unit, set "-1" to the axis that the data will not be output.

When the DC excitation is running (SV034/bit4=1):

Use this when the DC excitation is running (SV034/bit4=1) to adjust the initial magnetic pole position (when measuring the magnetic pole shift amount) for linear motor and direct-drive motor.

Set the initial excitation level in DC excitation control.

Set 10% as standard.

Related parameters: SV062, SV063

---Setting range---

-1 to 127

When the DC excitation is running (SV034/bit4=1): 0 to 100 (Stall current %)

【#2262】 SV062 DA2NO D/A output ch2 data No. / Final DC excitation level

Input the data number you wish to output to the D/A output channel 2.

When using the 2-axis drive unit, set "-1" to the axis that the data will not be output.

When the DC excitation is running (SV034/bit4=1):

Use this when the DC excitation is running (SV034/bit4=1) to adjust the initial magnetic pole position (when measuring the magnetic pole shift amount) for linear motor and direct-drive motor.

Set the final excitation level in DC excitation control.

Set 10% as standard.

When the magnetic pole shift amount measurement value is unsteady, adjust the value in increments of 5%.

Related parameters: SV061, SV063

---Setting range---

-1 to 127

When the DC excitation is running (SV034/bit4=1): 0 to 100 (Stall current %)

[#2263] SV063 DA1MPY D/A output ch1 output scale / Initial DC excitation time

Set output scale of the D/A output channel 1 in increment of 1/100.
When "0" is set, the magnification is the same as when "100" is set.

When the DC excitation is running (SV034/bit4=1):
Use this when the DC excitation is running (SV034/bit4=1) to adjust the initial magnetic pole position (when measuring the magnetic pole shift amount) for linear motor and direct-drive motor.
Set the initial excitation time in DC excitation control.
Set 1000ms as standard.
When the magnetic pole shift amount measurement value is unsteady, adjust the value in increments of 500ms.
Related parameters: SV061, SV062

---Setting range---

-32768 to 32767 (1/100-fold)

When the DC excitation is running (SV034/bit4=1): 0 to 10000 (ms)

 [#2264] SV064 DA2MPY D/A output ch2 output scale

Set output scale of the D/A output channel 2 in increment of 1/100.
When "0" is set, the magnification is the same as when "100" is set.

---Setting range---

-32768 to 32767 (1/100-fold)

 [#2265] SV065 TLC Machine end compensation gain

The shape of the machine end is compensated by compensating the spring effect from the machine end to the motor end.

Set the machine end compensation gain. Measure the error amount by roundness measurement and estimate the setting value by the following formula.

Compensation amount (μ m) = Command speed F(mm/min)² * SV065 / (Radius R(mm) * SV003 * 16,200,000)

Set to "0" when not using.

---Setting range---

-30000 to 30000 (Acceleration ratio 0.1%)

 [#2266-2272] SV066 - SV072

This parameter is set automatically by the NC system.

 [#2273(PR)] SV073 FEEDout Specified speed output speed

Set the specified speed.
Also set SV082/bit9,8 to output digital signal.

---Setting range---

0 to 32767 (r/min)

However, when SV033/bitD=1, the setting range is from 0 to 32767 (100mm/min).
(Only for MDS-D2/DH2 and MDS-DM2)

 [#2274-2280] SV074 - SV080

This parameter is set automatically by the NC system.

【#2281(PR) SV081 SPEC2 Servo specification 2

Select the servo functions.
 A function is assigned to each bit.
 Set this in hexadecimal format.

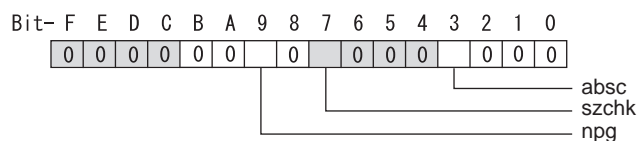

bit F-A :

Not used. Set to "0".

bit 9 : npg Earth fault detection

0: Disable 1: Enable (standard)
 Set "0" and it is constantly "Enable" for MDS-DJ-V1/V2 Series.

bit 8 :

Not used. Set to "0".

bit 7 : szchk Distance-coded reference scale reference mark

0: Check at 4 points (standard) 1: Check at 3 points

bit 6-4 :

Not used. Set to "0".

bit 3 : absc Distance-coded reference scale

0: Disable 1: Enable

bit 2-0 :

Not used. Set to "0".

【#2282】 SV082 SSF5 Servo function 5

Select the servo functions.
A function is assigned to each bit.
Set this in hexadecimal format.

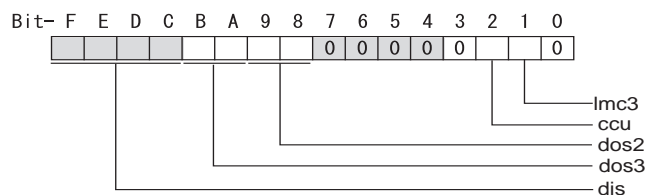
**bit F-C : dis Digital signal input selection**

- 0: No signal
- 1: SLS (Safely Limited Speed) function door state signal
- 2: Battery box voltage drop warning (It is not available for MDS-DJ-V1/V2 Series.)
- 3 to F: Setting prohibited

bit B-A : dos3 Digital signal output 3 selection

- bitB,A=
- 00: Disable
- 01: Setting prohibited
- 10: Contactor control signal output (For MDS-DJ-V1/V2)
- 11: Setting prohibited

bit 9-8 : dos2 Digital signal output 2 selection

- bit9,8=
- 00: Disable
- 01: Specified speed output
- 10: Setting prohibited
- 11: Setting prohibited

bit 7-3 :

Not used. Set to "0".

bit 2 : ccu Lost motion overshoot compensation compensation amount setting increment

- 0: Stall current % 1: Stall current 0.01%

bit 1 : Imc3 Lost motion compensation type 3

Set this when protrusion at a quadrant change is too big.
0: Stop 1: Start

Related parameters: SV016, SV041, SV085, SV086

bit 0 :

Not used. Set to "0".

【#2283】 SV083 SSF6 Servo function 6

Select the servo functions.
 A function is assigned to each bit.
 Set this in hexadecimal format.

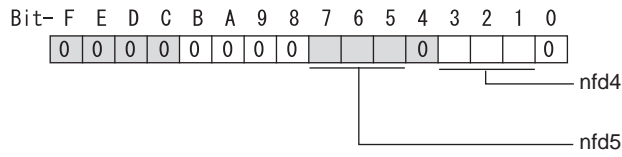

bit F-8 :

Not used. Set to "0".

bit 7-5 : nfd5 Depth of Notch filter 5

Set the depth of Notch filter 5 (SV088).
 bit7,6,5=
 000: - ∞
 001: -18.1[dB]
 010: -12.0[dB]
 011: -8.5[dB]
 100: -6.0[dB]
 101: -4.1[dB]
 110: -2.5[dB]
 111: -1.2[dB]

bit 4 :

Not used. Set to "0".

bit 3-1 : nfd4 Depth of Notch filter 4

Set the depth of Notch filter 4 (SV087).
 bit3,2,1=
 000: - ∞
 001: -18.1[dB]
 010: -12.0[dB]
 011: -8.5[dB]
 100: -6.0[dB]
 101: -4.1[dB]
 110: -2.5[dB]
 111: -1.2[dB]

bit 0 :

Not used. Set to "0".

【#2284】 SV084 SSF7 Servo function 7

Select the servo functions.
A function is assigned to each bit.
Set this in hexadecimal format.

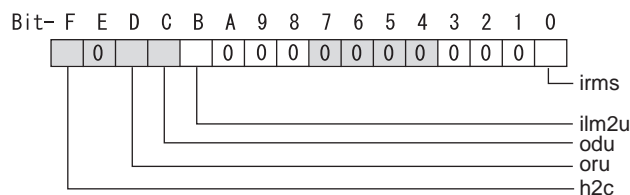
**bit F : h2c HAS control cancel amount**

0: 1/4 (standard) 1: 1/2

Related parameters: SV034/bit1

bit E :

Not used. Set to "0".

bit D : oru Overrun detection width unit

0: mm (normal setting) 1: μ m

bit C : odu Excessive error detection width unit

0: mm (normal setting) 1: μ m

bit B : ilm2u Current limit value (SV014) in special control setting unit

0: Stall current % (normal setting) 1: Stall current 0.01%

bit A-1 :

Not used. Set to "0".

bit 0 : irms Motor current display

0: Motor q axis current display (normal) 1: Motor effective current display

【#2285】 SV085 LMCK Lost motion compensation 3 spring constant

Set the machine system's spring constant when selecting lost motion compensation type 3.
When not using, set to "0".

Related parameters: SV016, SV041, SV082/bit2,1, SV086

---Setting range---

0 to 32767 (0.01%/ μ m)

【#2286】 SV086 LMCc Lost motion compensation 3 viscous coefficient

Set the machine system's viscous coefficient when selecting lost motion compensation type 3.
When not using, set to "0".

Related parameters: SV016, SV041, SV082/bit2,1, SV086

---Setting range---

0 to 32767 (0.01%*s/mm)

【#2287】 SV087 FHZ4 Notch filter frequency 4

Set the vibration frequency to suppress when machine vibration occurs.
(Normally, do not set 80 or less.)
Set to "0" when not using.

Related parameters: SV083/bit3-1, SV115

---Setting range---

0 to 2250 (Hz)

【#2288】 SV088 FHz5 Notch filter frequency 5

Set the vibration frequency to suppress when machine vibration occurs.
 (Normally, do not set 80 or less.)
 Set to "0" when not using.

Related parameters: SV083/bit7-5, SV115

---Setting range---
 0 to 2250 (Hz)

【#2289】 SV089

Not used. Set to "0".

【#2290】 SV090

Not used. Set to "0".

【#2291】 SV091 LMC4G Lost motion compensation 4 gain

Use this with LMC compensation type 3. As the delay in path tracking is monitored and compensated, the delay in path tracking will be minimized even if machine friction amount changes by aging. Use the lost motion compensation amount (SV016) * 5 (10% of the dynamic friction torque) as the target. The higher the setting value is, the more accurate the quadrant change be; however, the more likely vibrations occur.

---Setting range---
 0 to 20000 (Stall current 0.01%)

【#2292】 SV092

Not used. Set to "0".

【#2293】 SV093

Not used. Set to "0".

【#2294】 SV094 MPV Magnetic pole position error detection speed

The magnetic pole position detection function monitors the command speed and motor speed at the position command stop and detects the magnetic pole position error alarm (3E) if any. Set the error detection level for the command speed and motor speed at the position command stop. Be aware when setting the parameter as the setting units for general motors and linear motors are different.

<<For general motor>>

When the command speed error detection level is set to "0", the magnetic pole position error (3E) is detected at 10r/min.

Set "10" as standard.

This detects the magnetic pole position error (3E) when the motor rotation speed is 100r/min and more.

<<For linear motor>>

When the command motor speed level is set to "0", the magnetic pole position error (3E) is detected at 1mm/s.

Set "10" as standard.

This detects the magnetic pole position error (3E) when the motor speed is 10mm/s and more.

---Setting range---
 0 to 31999

<<For general motor>>

Ten-thousands digit, Thousands digit ----- Command speed error detection level (10r/min)

Hundreds digit, Tens digit, Ones digit ----- Motor speed error detection level (10r/min)

<<For linear motor>>

Ten-thousands digit, Thousands digit ----- Command speed error detection speed level (1mm/s)

Hundreds digit, Tens digit, Ones digit ----- Motor speed error detection level (1mm/s)

【#2295】 SV095 ZUPD Vertical axis pull up distance

Set this parameter to adjust the pull up distance when the vertical axis pull up function is enabled. When the pull up function is enabled and this parameter is set to "0", for a rotary motor, 8/1000 of a rotation at the motor end is internally set as the pull up distance, and for a linear motor, 80[μ m] is set.

Related parameters:

SV032 : The pull up direction is determined. When "0" is set, pull up control is not executed.

SV033/bitE : Start-up of the pull up function

SV048 : Set the drop prevention time. When "0" is set, pull up control is not executed.

---Setting range---

0 to 2000 (μ m)

【#2296】 SV096

Not used. Set to "0".

【#2297】 SV097

Not used. Set to "0".

【#2298】 SV098

Not used. Set to "0".

【#2299】 SV099

Not used. Set to "0".

【#2300】 SV100

Not used. Set to "0".

【#2301】 SV101 TMA1 OMR-FF movement averaging filter time constant 1

Set the movement averaging filter time constant in OMR-FF control.

The standard setting is "88".

Set to "0" when not using OMR-FF control.

---Setting range---

0 to 711 (0.01ms)

【#2302】 SV102 TMA2 OMR-FF movement averaging filter time constant 2

Set the movement averaging filter time constant in OMR-FF control.

The standard setting is "88".

Set to "0" when not using OMR-FF control.

---Setting range---

0 to 711 (0.01ms)

【#2303】 SV103

Not used. Set to "0".

【#2304】 SV104 FFR0 OMR-FF inner rounding compensation gain for G0

Set the inner rounding compensation amount (drive side feed forward gain) in OMR-FF control. When a shape tracking error is too large in OMR-FF control, adjust it by setting this parameter.

The higher the setting value is, the less the shape tracking error will be, however, overshooting during acceleration/deceleration will increase.

Lower the value when vibration occurs during the G0 acceleration/deceleration.

The standard setting is "10000".

Set to "0" when not using OMR-FF control.

---Setting range---

0 to 20000 (0.01%)

【#2305】 SV105 FFR1 OMR-FF inner rounding compensation gain for G1

Set the inner rounding compensation amount (drive side feed forward gain) in OMR-FF control. When a shape tracking error is too large in OMR-FF control, adjust it by setting this parameter. The higher the setting value is, the less the shape tracking error will be, however, overshooting during acceleration/deceleration will increase.
Lower the value when vibration occurs during the G1 acceleration/deceleration.
The standard setting is "10000".
Set to "0" when not using OMR-FF control.

---Setting range---
0 to 20000 (0.01%)

【#2306】 SV106 PGM OMR-FF scale model gain

Set the scale model gain (position response) in OMR-FF control. Set the same value as SV003(PGN1).
Increase the setting value to perform a high-speed machining such as a fine arc or to improve the path error.
Lower the value when vibration occurs during acceleration/deceleration.
Set to "0" when not using OMR-FF control.

---Setting range---
0 to 300 (rad/s)

【#2307】 SV107

Not used. Set to "0".

【#2308】 SV108

Not used. Set to "0".

【#2309】 SV109

Not used. Set to "0".

【#2310】 SV110

Not used. Set to "0".

【#2311】 SV111

Not used. Set to "0".

【#2312】 SV112 IFF OMR-FF current feed forward gain

Set the current feed forward rate in OMR-FF control. The standard setting is "10000".
Setting value of 0 is equal to "10000(100%)" setting.
Set to "0" when not using OMR-FF control.

---Setting range---
0 to 32767 (0.01%)

【#2313】 SV113 SSF8 Servo function 8

Select the servo functions.
A function is assigned to each bit.
Set this in hexadecimal format.

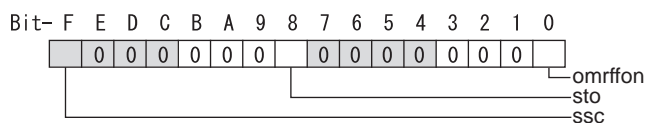
**bit F : ssc SLS (Safely Limited Speed) function**

0: Stop 1: Start

bit E-9 :

Not used. Set to "0".

bit 8 : sto Dedicated wiring STO function

Set this parameter to use dedicated wiring STO function.
0: Dedicated wiring STO function unused 1: Dedicated wiring STO function used

bit 7-1 :

Not used. Set to "0".

bit 0 : omrffon OMR-FF control enabled

0: Disable 1: Enable

【#2314】 SV114 SSF9 Servo function 9

Select the servo functions.
A function is assigned to each bit.
Set this in hexadecimal format.

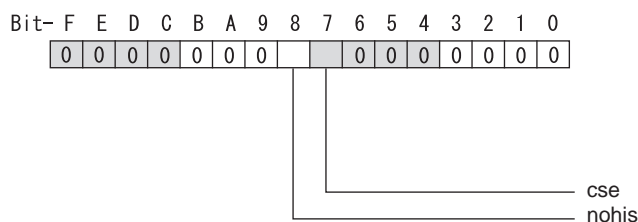
**bit F-9 :**

Not used. Set to "0".

bit 8 : nohis History of communication error alarm between NC and DRV (34, 36, 38, 39)

0: Enable 1: Disable

bit 7 : cse Command speed monitoring function

0: Normal setting 1: Enable

bit 6-0 :

Not used. Set to "0".

【#2315】 SV115 SSF10 Servo function 10

Select the servo functions.
A function is assigned to each bit.
Set this in hexadecimal format.

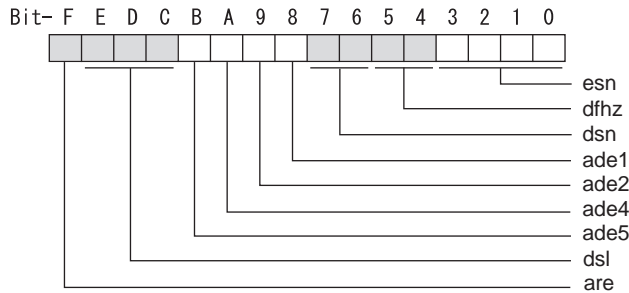

bit F : are Notch filter5 all frequencies adapted

When enabled, Notch filter5 all frequencies adaptive range is not limited regardless of SV115/bit4,5 setting.
0: Disable 1: Enable

bit E-C: dsl Notch filter frequency display

Switch the "AFLT frequency" display on drive monitor screen to check every notch filter frequency. When the selected notch filter is not used, "0" is displayed.

- bitE,D,C=
- 000 : Estimated resonance frequency (Normal display)
 - 001 : Notch filter 1 frequency
 - 010 : Notch filter 2 frequency
 - 011 : Notch filter 3 frequency (always displays 1125Hz)
 - 100 : Notch filter 4 frequency
 - 101 : Notch filter 5 frequency
 - Other settings: setting prohibited

bit B : ade5 Notch filter 5 / Adaptive follow-up function

0: Disable 1: Enable

bit A : ade4 Notch filter 4 / Adaptive follow-up function

0: Disable 1: Enable

bit 9 : ade2 Notch filter 2 / Adaptive follow-up function

0: Disable 1: Enable

bit 8 : ade1 Notch filter 1 / Adaptive follow-up function

0: Disable 1: Enable

bit 7-6 : dsn Estimated resonance frequency display holding time

Set the estimated resonance frequency display holding time to the "AFLT frequency" display on drive monitor screen.

- bit7,6=
- 00: 4 [s]
 - 01: 8 [s]
 - 10: 12 [s]
 - 11: 16 [s]

bit 5-4 : dfhz Notch filter frequency range

Set the adaptive range of the notch filter frequency. When the adaptive follow-up function is enabled and if the estimated resonance frequency exists in the set range, the notch filter will be adapted. Normally set this parameter to "00".

- bit5,4=
- 00: -10 to 10 [%]
 - 01: -20 to 20 [%]
 - 10: -30 to 30 [%]
 - 11: -40 to 40 [%]

bit 3-0 : esn Sensitivity of estimated resonance frequency

Set the sensitivity of the estimated resonance frequency. Smaller setting value enables to detect smaller vibration component, however, adaptive movement will be repeated frequently. Normally set this parameter to "0".

0 : Normal setting (same sensitivity as A) 1 : Sensitivity high to F : Sensitivity low

【#2316】 SV116 SSF11 Servo function 11

Not used. Set to "0000".

【#2317(PR)】 SV117 RNG1ex Expansion sub side detector resolution

For high-accuracy binary resolution detector, set the number of pulses to four bite data of SV117 (high-order) and SV019 (low-order) by pulse(p).
When SV117=0, the setting unit of SV019 is (kp).
Refer to SV019 for details.

Related parameters: SV019, SV020, SV118

---Setting range---

-1 to 32767

【#2318(PR)】 SV118 RNG2ex Expansion main side detector resolution

When using high-accuracy binary resolution detector, set the number of pulses to four bite data of SV118 (high-order) and SV020 (low-order) by pulse(p).
When SV118=0, the setting unit of SV020 is (kp).
Refer to SV020 for details.

Related parameters: SV019, SV020, SV117

---Setting range---

-1 to 32767

【#2319】 SV119

Not used. Set to "0".

【#2320】 SV120

Not used. Set to "0".

【#2321】 SV121

Not used. Set to "0".

【#2322】 SV122

Not used. Set to "0".

【#2323】 SV123

Not used. Set to "0".

【#2324】 SV124

Not used. Set to "0".

【#2325】 SV125

Not used. Set to "0".

【#2326】 SV126

Not used. Set to "0".

【#2327】 SV127

Not used. Set to "0".

【#2328】 SV128

Not used. Set to "0".

【#2329】 SV129 Kwf Synchronous control feed forward filter frequency

Set the acceleration rate feed forward filter frequency in high-speed synchronous tapping control. The standard setting is "600".

Related parameters: SV244

---Setting range---

0 to 32767 (rad/s)

【#2330(PR)】 SV130 RPITS Base reference mark interval

Set the base reference mark intervals of distance-coded reference scale. When the distance-coded reference scale is not used, set to "0".

The interval of basic reference mark (SV130) and auxiliary interval (SV131) must be in the specified relationship. Other settings cause the initial parameter error (alarm 37). Following is the specified relationship.

The quotient of $(SV130 \times 1000) / SV131$ must be 4 or more and leaves no remainder.

Related parameters: SV081/bit7,3, SV131, SV134 to SV137

---Setting range---

0 to 32767 (mm)

【#2331(PR)】 SV131 DPITS Auxiliary reference mark interval

Set the auxiliary interval of reference mark in the distance-coded reference scale. When the distance-coded reference scale is not used, set to "0".

The interval of basic reference mark (SV130) and auxiliary interval (SV131) must be in the specified relationship. Other settings cause the initial parameter error (alarm 37). Following is the specified relationship.

The quotient of $(SV130 \times 1000) / SV131$ must be 4 or more and leaves no remainder.

Related parameters: SV081/bit7,3, SV130, SV134 to SV137

---Setting range---

0 to 32767 (μ m)

【#2332】 SV132

Not used. Set to "0".

【#2333】 SV133

Not used. Set to "0".

【#2334】 SV134 RRn0 Distance-coded reference check / revolution counter

Set this parameter to operate distance-coded reference check when using distance-coded reference scale.

During the distance-coded reference check initial setup (SV137:RAER=-1), set the following items on the NC drive monitor screen after the distance-coded reference check initial setup warning A3 turns OFF.

SV134=Rn, SV135=Pn, SV136=MPOS

When reference point is set, the warning A3 turns OFF.

To enable the distance-coded reference check function, SV081/bit3=1 setting and a battery option are needed.

Related parameters: SV081/bit3,7, SV130, SV131, SV134 to SV137

---Setting range---

-32768 to 32767

【#2335】 SV135 RPN0H Distance-coded reference check / position within one rotation High

Set this parameter to operate distance-coded reference check when using distance-coded reference scale.

During the distance-coded reference check initial setup (SV137:RAER=-1), set the following items on the NC drive monitor screen after the distance-coded reference check initial setup warning A3 turns OFF.

SV134=Rn, SV135=Pn, SV136=MPOS

When reference point is set, the warning A3 turns OFF.

To enable the distance-coded reference check function, SV081/bit3=1 setting and a battery option are needed.

Related parameters: SV081/bit3,7, SV130, SV131, SV134 to SV137

---Setting range---
-32768 to 32767

【#2336】 SV136 RPN0L Distance-coded reference check / position within one rotation Low

Set this parameter to operate distance-coded reference check when using distance-coded reference scale.

During the distance-coded reference check initial setup (SV137:RAER=-1), set the following items on the NC drive monitor screen after the distance-coded reference check initial setup warning A3 turns OFF.

SV134=Rn, SV135=Pn, SV136=MPOS

When reference point is set, the warning A3 turns OFF.

To enable the distance-coded reference check function, SV081/bit3=1 setting and a battery option are needed.

Related parameters: SV081/bit3,7, SV130, SV131, SV134 to SV137

---Setting range---
-32768 to 32767

【#2337】 SV137 RAER Distance-coded reference check allowable width

For the distance-coded reference check function when using distance-coded reference scale, set the allowable gap from the reference point position data calculated by the main side detector. When the gap exceeds the allowable range, reference point created by distance-code is judged as wrong and detects alarm 42.

The standard setting value is "basic reference mark interval (SV130) / 4".

SV137=0 setting carries out the same operation as the standard setting value.

SV137=-1 setting enables the distance-coded reference initial set up mode and displays setting values of SV134 to SV136 on NC drive monitor.

To enable the distance-coded reference check function, SV081/bit3=1 setting and a battery option are needed.

When SV137=32767, the distance-coded reference check function is disabled.

Related parameters: SV081/bit3,7, SV130, SV131, SV134 to SV136

---Setting range---
-1 to 32767 (mm)

【#2338-2397】 SV138 - SV197

Not used. Set to "0".

【#2398】 SV198 NSE No signal 2 special detection width

Set the special detection width for the no signal 2 (alarm 21).

This detects no signal 2 (alarm 21) when machine side feedback is not invoked even if the motor side detector feedback exceeds this setting in the rectangular wave signal output linear scale.

When "0" is set, the detection will be performed with a 15 μ m width.

---Setting range---
0 to 32767 (μ m)

【#2399-2437】 SV199 - SV237

Not used. Set to "0".

【#2438】 SV238 SSCFEED Safely limited speed

Set the machine's safely limited speed for the SLS (Safely Limited Speed) function.
Set this parameter within the following setting ranges.

For linear axis: 2000mm/min or less

For rotary axis: 18000°/min (50r/min) or less

When not using, set to "0".

Related parameters: SV033/bitD, SV113/bitF, SV239

---Setting range---

0 to 18000 (mm/min) or (°/min)

However, when SV033/bitD=1, the setting range is from -32768 to 32767 (100 mm/min) or (100°/min).

【#2439】 SV239 SSCRPM Safely limited motor speed

Set the motor's safely limited speed for the SLS (Safely Limited Speed) function.

Set a value to hold the following relationship.

Be aware when setting the parameter as the setting units for general motors and linear motors are different.

<<For general motor>>

$$SV239 = (SV238/SV018) \times (SV002/SV001)$$

Only when the product is 0, set to "1".

<<For linear motor>>

$$SV239 = SV238/60$$

Only when the product is 0, set to "1".

When not using, set to "0".

---Setting range---

For general motor: 0 to 32767 (r/min)

For linear motor: 0 to 32767 (mm/s)

【#2440-2443】 SV240 - SV243

Not used. Set to "0".

【#2444(PR)】 SV244 DUNIT Communication interpolation unit for communication among drive units

Set the communication interpolation unit among drive units in high-speed synchronous tapping control.

When set to "0", it will be regarded as 20 (0.05 μ m) is set.

Related parameters: SV129

---Setting range---

0 to 2000 (1/ μ m)

【#2445-2456】 SV245 - SV256

Not used. Set to "0".

2.6 Spindle Parameters

The parameters with "(PR)" requires the CNC to be turned OFF after the settings. Turn the power OFF and ON to enable the parameter settings.

(Note) The parameter descriptions given here are intended for MDS-D2/DH2, MDS-DM2 and MDS-DJ Series.

If your drive system is MDS-D/DH, MDS-DM or MDS-D-SVJ3/SPJ3 Series, refer to the appropriate drive instruction manual. Some parameters have different specifications under these systems.

【#3001】 slimt 1 Limit rotation speed (Gear: 00)

Set the spindle rotation speed for maximum motor speed when gear 00 is selected.
Set the spindle rotation speed for the S analog output=10V during analog spindle control.

---Setting range---
0 to 99999 (r/min)

【#3002】 slimt 2 Limit rotation speed (Gear: 01)

Set the spindle rotation speed for maximum motor speed when gear 01 is selected.
Set the spindle rotation speed for the S analog output=10V during analog spindle control.

---Setting range---
0 to 99999 (r/min)

【#3003】 slimt 3 Limit rotation speed (Gear: 10)

Set the spindle rotation speed for maximum motor speed when gear 10 is selected.
Set the spindle rotation speed for the S analog output=10V during analog spindle control.

---Setting range---
0 to 99999 (r/min)

【#3004】 slimt 4 Limit rotation speed (Gear: 11)

Set the spindle rotation speed for maximum motor speed when gear 11 is selected.
Set the spindle rotation speed for the S analog output=10V during analog spindle control.

---Setting range---
0 to 99999 (r/min)

【#3005】 smax 1 Maximum rotation speed (Gear: 00)

Set the maximum spindle rotation speed which is actually commanded when gear 00 is selected.
Set this as $smax1(\#3005) \leq slimit1(\#3001)$.
By comparing the S command value and the values of gear 1 - 4, a spindle gear shift command will be output automatically.

---Setting range---
0 to 99999 (r/min)

【#3006】 smax 2 Maximum rotation speed (Gear: 01)

Set the maximum spindle rotation speed which is actually commanded when gear 01 is selected.
Set this as $smax2(\#3006) \leq slimit2(\#3002)$.
By comparing the S command value and the values of gear 1 - 4, a spindle gear shift command will be output automatically.

---Setting range---
0 to 99999 (r/min)

【#3007】 smax 3 Maximum rotation speed (Gear: 10)

Set the maximum spindle rotation speed which is actually commanded when gear 10 is selected.
Set this as $smax3(\#3007) \leq slimit3(\#3003)$.
By comparing the S command value and the values of gear 1 - 4, a spindle gear shift command will be output automatically.

---Setting range---
0 to 99999 (r/min)

【#3008】 smax 4 Maximum rotation speed (Gear: 11)

Set the maximum spindle rotation speed which is actually commanded when gear 11 is selected.
Set this as $\text{smax4}(\#3008) \leq \text{slimit4}(\#3004)$.
By comparing the S command value and the values of gear 1 - 4, a spindle gear shift command will be output automatically.

---Setting range---
0 to 99999 (r/min)

【#3009】 ssift 1 Shift rotation speed (Gear: 00)

Set the spindle speed for gear shifting with gear 00.
(Note) Setting too large value may cause a gear nick when changing gears.

---Setting range---
0 to 32767 (r/min)

【#3010】 ssift 2 Shift rotation speed (Gear: 01)

Set the spindle speed for gear shifting with gear 01.
(Note) Setting too large value may cause a gear nick when changing gears.

---Setting range---
0 to 32767 (r/min)

【#3011】 ssift 3 Shift rotation speed (Gear: 10)

Set the spindle speed for gear shifting with gear 10.
(Note) Setting too large value may cause a gear nick when changing gears.

---Setting range---
0 to 32767 (r/min)

【#3012】 ssift 4 Shift rotation speed (Gear: 11)

Set the spindle speed for gear shifting with gear 11.
(Note) Setting too large value may cause a gear nick when changing gears.

---Setting range---
0 to 32767 (r/min)

【#3013】 stap 1 Synchronous tapping 1st step rotation speed (Gear: 00)

Set the speed which switches from 1st step to 2nd step in synchronous tapping multi-step acceleration/deceleration control when gear 00 is selected.
The inclination of linear acceleration/deceleration control for 1st step is determined by the ratio of $\text{stap1}(\#3013)$ to $\text{stap1}(\#3017)$.
When the inclination is not set after 2nd step or it is higher than that of 1st step, the acceleration/deceleration control is executed with the same inclination as the 1st step for the rotation speed of stap1 or higher.

---Setting range---
0 to 99999 (r/min)

【#3014】 stap 2 Synchronous tapping 1st step rotation speed (Gear: 01)

Set the speed which switches from 1st step to 2nd step in synchronous tapping multi-step acceleration/deceleration control when gear 01 is selected.
The inclination of linear acceleration/deceleration control for 1st step is determined by the ratio of $\text{stap2}(\#3014)$ to $\text{stap2}(\#3018)$.
When the inclination is not set after 2nd step or it is higher than that of 1st step, the acceleration/deceleration control is executed with the same inclination as the 1st step for the rotation speed of stap2 or higher.

---Setting range---
0 to 99999 (r/min)

【#3015】 stap 3 Synchronous tapping 1st step rotation speed (Gear: 10)

Set the speed which switches from 1st step to 2nd step in synchronous tapping multi-step acceleration/deceleration control when gear 10 is selected.

The inclination of linear acceleration/deceleration control for 1st step is determined by the ratio of stap3(#3015) to stapt3(#3019).

When the inclination is not set after 2nd step or it is higher than that of 1st step, the acceleration/deceleration control is executed with the same inclination as the 1st step for the rotation speed of stap3 or higher.

---Setting range---

0 to 99999 (r/min)

【#3016】 stap 4 Synchronous tapping 1st step rotation speed (Gear: 11)

Set the speed which switches from 1st step to 2nd step in synchronous tapping multi-step acceleration/deceleration control when gear 11 is selected.

The inclination of linear acceleration/deceleration control for 1st step is determined by the ratio of stap4(#3016) to stapt4(#3020).

When the inclination is not set after 2nd step or it is higher than that of 1st step, the acceleration/deceleration control is executed with the same inclination as the 1st step for the rotation speed of stap4 or higher.

---Setting range---

0 to 99999 (r/min)

【#3017】 stapt 1 Synchronous tapping 1st step acceleration/deceleration time constant (Gear: 00)

Set the time constant for synchronous tapping 1st step linear acceleration/deceleration control when gear 00 is selected. (linear acceleration/deceleration pattern)

---Setting range---

1 to 5000 (ms)

【#3018】 stapt 2 Synchronous tapping 1st step acceleration/deceleration time constant (Gear: 01)

Set the time constant for synchronous tapping 1st step linear acceleration/deceleration control when gear 01 is selected. (linear acceleration/deceleration pattern)

---Setting range---

1 to 5000 (ms)

【#3019】 stapt 3 Synchronous tapping 1st step acceleration/deceleration time constant (Gear: 10)

Set the time constant for synchronous tapping 1st step linear acceleration/deceleration control when gear 10 is selected. (linear acceleration/deceleration pattern)

---Setting range---

1 to 5000 (ms)

【#3020】 stapt 4 Synchronous tapping 1st step acceleration/deceleration time constant (Gear: 11)

Set the time constant for synchronous tapping 1st step linear acceleration/deceleration control when gear 11 is selected. (linear acceleration/deceleration pattern)

---Setting range---

1 to 5000 (ms)

【#3021】

Not used. Set to "0".

【#3022】 sgear Encoder gear ratio

Set the deceleration rate of the detector to the spindle when inputting ABZ pulse output detector feedback to NC during analog spindle control.

- 0: 1/1
- 1: 1/2
- 2: 1/4
- 3: 1/8

---Setting range---
0 to 3

【#3023】 smini Minimum rotation speed

Set the minimum spindle speed.

If an S command below this setting is issued, the spindle will rotate at the minimum speed set by this parameter.

---Setting range---
0 to 32767 (r/min)

【#3024(PR)】 sout Spindle connection

Select the connection method with a spindle drive unit.

- 0: No unit to connect
- 1: Optical digital communication (Mitsubishi spindle drive unit)
- 2 - 5: S-analog (Analog spindle drive unit)

---Setting range---
0 to 5

【#3025(PR)】 enc-on Spindle encoder

Set the connection specifications of a spindle's detector.

- 0: Without detector feedback when using analog spindle and connecting to NC
- 1: With detector feedback when using analog spindle and connecting to NC
- 2: Mitsubishi spindle drive unit

---Setting range---
0 to 2

【#3026】 cs_ori Selection of winding in orientation mode

Select the coil control in orientation mode for the spindle motor which performs coil changeover.

- 0: Perform coil changeover based on the command from NC. (depending on the setting of parameter #1239/bit0)
- 1: Use the coil L

【#3027】 cs_syn Selection of winding in spindle synchronization control mode

Select the coil control in spindle synchronization control mode for the spindle motor which performs coil changeover.

- 0: Perform coil changeover based on the command from NC. (depending on the setting of parameter #1239/bit0)
- 1: Use the coil H

【#3028】 sprcmm Tap cycle M command selection

Set the M codes for the spindle forward run/reverse run commands during asynchronous tapping.

High-order 3 digits: Set the M code for spindle forward run command.

Low-order 3 digits: Set the M code for spindle reverse run command.

When "0" is set, it is handled assuming that "3004" is set (the M code for spindle forward run command is "3" and the M code for spindle reverse run command is "4").

---Setting range---
0 to 999999

【#3029】 tapsel Asynchronous tap gear selection

Select the speed which is compared with S command at gear selection when using asynchronous tapping control with the spindle which performs gear changeover.

0: Synchronous tapping 1st step rotation speed (stap)--- Multi-step acceleration/deceleration is not used.

1: Maximum speed (smax)--- Multi-step acceleration/deceleration is used.

This parameter is enabled only when "#1272 ext08/bit1 is 1".

【#3030】

Not used. Set to "0".

【#3031(PR)】 smcp_no Drive unit I/F channel No. (spindle)

Set the interface channel No. of CNC control unit to which the spindle is connected and the axis No. within each channel.

Set this parameter in 4-digit (hexadecimal) format.

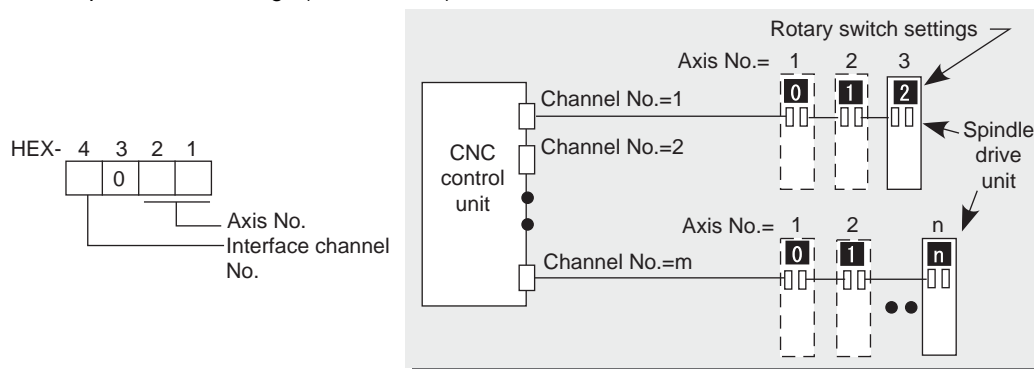

HEX-4 : Drive unit interface channel No.

HEX-3 : Not used. Set to "0".

HEX-2, 1 : Axis No.

For an analog spindle, set to "0000".

---Setting range---

0000, 1001 to 1010, 2001 to 2010

- For MDS-DM2-SPV2/SPV3 Series

These drive units have no rotary switches for axis No. selection.

The spindle axis No. is fixed to 1st axis, so set "01" as the number of axes. (last 2 digits).

【#3032】

Not used. Set to "0".

【#3035(PR)】 spunit Output unit

Select the data unit for communication with the spindle drive unit.

This selection is applied to the data communicated between the NC and spindle drive unit as well as the spindle movement data.

Spindle/C axis depends on this parameter setting and the C axis output unit (servo) is ignored.

B: 1 μ m

C: 0.1 μ m

【#3037】 taps21 Synchronous tapping 2nd step rotation speed (Gear: 00)

Set the speed which switches from 2nd step to 3rd step in synchronous tapping multi-step acceleration/deceleration control when gear 00 is selected.

The inclination of linear acceleration/deceleration control for 2nd step is determined by the ratio of taps21(#3037) to tapt21(#3041).

When the inclination is not set for 3rd step or it is higher than that of 2nd step, the acceleration/deceleration control is executed with the same inclination as the 2nd step for the rotation speed of taps21 or higher.

---Setting range---

0 to 99999 (r/min)

【#3038】 taps22 Synchronous tapping 2nd step rotation speed (Gear: 01)

Set the speed which switches from 2nd step to 3rd step in synchronous tapping multi-step acceleration/deceleration control when gear 01 is selected.
 The inclination of linear acceleration/deceleration control for 2nd step is determined by the ratio of taps22(#3038) to tapt22(#3042).
 When the inclination is not set for 3rd step or it is higher than that of 2nd step, the acceleration/deceleration control is executed with the same inclination as the 2nd step for the rotation speed of taps22 or higher.

---Setting range---
 0 to 99999 (r/min)

【#3039】 taps23 Synchronous tapping 2nd step rotation speed (Gear: 10)

Set the speed which switches from 2nd step to 3rd step in synchronous tapping multi-step acceleration/deceleration control when gear 10 is selected.
 The inclination of linear acceleration/deceleration control for 2nd step is determined by the ratio of taps23(#3039) to tapt23(#3043).
 When the inclination is not set for 3rd step or it is higher than that of 2nd step, the acceleration/deceleration control is executed with the same inclination as the 2nd step for the rotation speed of taps23 or higher.

---Setting range---
 0 to 99999 (r/min)

【#3040】 taps24 Synchronous tapping 2nd step rotation speed (Gear: 11)

Set the speed which switches from 2nd step to 3rd step in synchronous tapping multi-step acceleration/deceleration control when gear 11 is selected.
 The inclination of linear acceleration/deceleration control for 2nd step is determined by the ratio of taps24(#3040) to tapt24(#3044).
 When the inclination is not set for 3rd step or it is higher than that of 2nd step, the acceleration/deceleration control is executed with the same inclination as the 2nd step for the rotation speed of taps24 or higher.

---Setting range---
 0 to 99999 (r/min)

【#3041】 tapt21 Synchronous tapping 2nd step acceleration/deceleration time constant (Gear: 00)

Set the time constant for synchronous tapping 2nd step linear acceleration/deceleration control when gear 00 is selected.

---Setting range---
 1 to 5000 (ms)

【#3042】 tapt22 Synchronous tapping 2nd step acceleration/deceleration time constant 2 (Gear: 01)

Set the time constant for synchronous tapping 2nd step linear acceleration/deceleration control when gear 01 is selected.

---Setting range---
 1 to 5000 (ms)

【#3043】 tapt23 Synchronous tapping 2nd step acceleration/deceleration time constant (Gear: 10)

Set the time constant for synchronous tapping 2nd step linear acceleration/deceleration control when gear 10 is selected.

---Setting range---
 1 to 5000 (ms)

[#3044] tapt24 Synchronous tapping 2nd step acceleration/deceleration time constant (Gear: 11)

Set the time constant for synchronous tapping 2nd step linear acceleration/deceleration control when gear 11 is selected.

---Setting range---
1 to 5000 (ms)

 [#3045] tapt31 Synchronous tapping 3rd step acceleration/deceleration time constant (Gear: 00)

Set the time constant for synchronous tapping 3rd step linear acceleration/deceleration control when gear 00 is selected.
The inclination of linear acceleration/deceleration control for 3rd step is determined by the ratio of slimit1(#3001) to tapt31(#3045).

---Setting range---
1 to 5000 (ms)

 [#3046] tapt32 Synchronous tapping 3rd step acceleration/deceleration time constant (Gear: 01)

Set the time constant for synchronous tapping 3rd step linear acceleration/deceleration control when gear 01 is selected.
The inclination of linear acceleration/deceleration control for 3rd step is determined by the ratio of slimit2(#3002) to tapt32(#3046).

---Setting range---
1 to 5000 (ms)

 [#3047] tapt33 Synchronous tapping 3rd step acceleration/deceleration time constant (Gear: 10)

Set the time constant for synchronous tapping 3rd step linear acceleration/deceleration control when gear 10 is selected.
The inclination of linear acceleration/deceleration control for 3rd step is determined by the ratio of slimit3(#3003) to tapt33(#3047).

---Setting range---
1 to 5000 (ms)

 [#3048] tapt34 Synchronous tapping 3rd step acceleration/deceleration time constant (Gear: 11)

Set the time constant for synchronous tapping 3rd step linear acceleration/deceleration control when gear 11 is selected.
The inclination of linear acceleration/deceleration control for 3rd step is determined by the ratio of slimit4(#3004) to tapt34(#3048).

---Setting range---
1 to 5000 (ms)

 [#3049] spt Spindle synchronization acceleration/deceleration time constant

Set the acceleration/deceleration time constant under spindle synchronization control.
The inclination of acceleration/deceleration control is determined by the ratio to limit rotation speed (slimit). Set the same value for the reference axis and synchronous axis.
The time constant for 2nd step or subsequent steps is the magnification setting on the basis of this setting value.

---Setting range---
0 to 9999 (ms)

【#3050】 sprlv Spindle synchronization rotation speed attainment level

Set the level of speed difference between the basic and synchronous spindles during spindle synchronization control. Setting of the synchronous spindle side is enabled. When the difference becomes below the setting level, the spindle speed synchronization complete signal will turn ON.

---Setting range---
0 to 4095 (pulse) (1 pulse = 0.088°)

【#3051】 spplv Spindle phase synchronization attainment level

Set the level of phase difference between the basic and synchronous spindles during spindle synchronization. Setting of the synchronous spindle side is validated. When the difference becomes below the setting level, the spindle phase synchronization complete signal will go ON.

---Setting range---
0 to 4095 (pulse) (1 pulse = 0.088°)

【#3052】 spplr Spindle motor spindle relative polarity

Set the spindle motor and spindle's relative polarity.
0: Positive polarity
(Spindle CW rotation at motor CW rotation)
1: Negative polarity
(Spindle CCW rotation at motor CW rotation)

【#3053】 sppst Spindle encoder Z -phase position

Set the deviation amount from the spindle's basic point to the spindle detector's Z phase. Obtain the deviation amount, considering a clockwise direction as positive when viewed from the spindle's front side.

---Setting range---
0 to 359999 (1/1000°)

【#3054】 sptc1 Spindle synchronization multi-step acceleration/deceleration changeover speed 1

Set the speed which switches from 1st step to 2nd step in spindle synchronization multi-step acceleration/deceleration control. Set the same value for the reference axis and synchronous axis. Set the value of limit rotation speed (slimit) or higher not to carry out a step shift.

---Setting range---
0 to 99999 (r/min)

【#3055】 sptc2 Spindle synchronization multi-step acceleration/deceleration changeover speed 2

Set the speed which switches from 2nd step to 3rd step in spindle synchronization multi-step acceleration/deceleration control. Set the same value for the reference axis and synchronous axis. Set the value of limit rotation speed (slimit) or higher not to carry out a step shift.

---Setting range---
0 to 99999 (r/min)

【#3056】 sptc3 Spindle synchronization multi-step acceleration/deceleration changeover speed 3

Set the speed which switches from 3rd step to 4th step in spindle synchronization multi-step acceleration/deceleration control. Set the same value for the reference axis and synchronous axis. Set the value of limit rotation speed (slimit) or higher not to carry out a step shift.

---Setting range---
0 to 99999 (r/min)

[#3057] sptc4 Spindle synchronization multi-step acceleration/deceleration changeover speed 4

Set the speed which switches from 4th step to 5th step in spindle synchronization multi-step acceleration/deceleration control. Set the same value for the reference axis and synchronous axis. Set the value of limit rotation speed (slimit) or higher not to carry out a step shift.

---Setting range---
0 to 99999 (r/min)

 [#3058] sptc5 Spindle synchronization multi-step acceleration/deceleration changeover speed 5

Set the speed which switches from 5th step to 6th step in spindle synchronization multi-step acceleration/deceleration control. Set the same value for the reference axis and synchronous axis. Set the value of limit rotation speed (slimit) or higher not to carry out a step shift.

---Setting range---
0 to 99999 (r/min)

 [#3059] sptc6 Spindle synchronization multi-step acceleration/deceleration changeover speed 6

Set the speed which switches from 6th step to 7th step in spindle synchronization multi-step acceleration/deceleration control. Set the same value for the reference axis and synchronous axis. Set the value of limit rotation speed (slimit) or higher not to carry out a step shift.

---Setting range---
0 to 99999 (r/min)

 [#3060] sptc7 Spindle synchronization multi-step acceleration/deceleration changeover speed 7

Set the speed which switches from 7th step to 8th step in spindle synchronization multi-step acceleration/deceleration control. Set the same value for the reference axis and synchronous axis. Set the value of limit rotation speed (slimit) or higher not to carry out a step shift.

---Setting range---
0 to 99999 (r/min)

 [#3061] spdiv1 Time constant magnification for changeover speed 1

Set the acceleration/deceleration time constant to be used at the speed of changeover speed 1 (sptc1) and higher in spindle synchronization multi-step acceleration/deceleration control. Set this as a magnification in relation to the spindle synchronization acceleration/deceleration time constant (spt).

---Setting range---
0 to 127

 [#3062] spdiv2 Time constant magnification for changeover speed 2

Set the acceleration/deceleration time constant to be used at the speed of changeover speed 2 (sptc2) and higher in spindle synchronization multi-step acceleration/deceleration control. Set this as a magnification in relation to the spindle synchronization acceleration/deceleration time constant (spt).

---Setting range---
0 to 127

 [#3063] spdiv3 Time constant magnification for changeover speed 3

Set the acceleration/deceleration time constant to be used at the speed of changeover speed 3 (sptc3) and higher in spindle synchronization multi-step acceleration/deceleration control. Set this as a magnification in relation to the spindle synchronization acceleration/deceleration time constant (spt).

---Setting range---
0 to 127

【#3064】 spdiv4 Time constant magnification for changeover speed 4

Set the acceleration/deceleration time constant to be used at the speed of changeover speed 4 (sptc4) and higher in spindle synchronization multi-step acceleration/deceleration control. Set this as a magnification in relation to the spindle synchronization acceleration/deceleration time constant (spt).

---Setting range---

0 to 127

【#3065】 spdiv5 Time constant magnification for changeover speed 5

Set the acceleration/deceleration time constant to be used at the speed of changeover speed 5 (sptc5) and higher in spindle synchronization multi-step acceleration/deceleration control. Set this as a magnification in relation to the spindle synchronization acceleration/deceleration time constant (spt).

---Setting range---

0 to 127

【#3066】 spdiv6 Time constant magnification for changeover speed 6

Set the acceleration/deceleration time constant to be used at the speed of changeover speed 6 (sptc6) and higher in spindle synchronization multi-step acceleration/deceleration control. Set this as a magnification in relation to the spindle synchronization acceleration/deceleration time constant (spt).

---Setting range---

0 to 127

【#3067】 spdiv7 Time constant magnification for changeover speed 7

Set the acceleration/deceleration time constant to be used at the speed of changeover speed 7 (sptc7) and higher in spindle synchronization multi-step acceleration/deceleration control. Set this as a magnification in relation to the spindle synchronization acceleration/deceleration time constant (spt).

---Setting range---

0 to 127

【#3068】 symtm1 Phase synchronization start confirmation time

Set the time to confirm that synchronization is attained before spindle phase synchronization control is started.

When "0" is set, the time will be 500ms. When "100" or less is set, the time will be 100ms.

---Setting range---

0 to 9999 (ms)

【#3069】 symtm2 Phase synchronization end confirmation time

Set a period of waiting time for spindle phase synchronization control's completion as a time in which the speed stays within the attainment range.

When "0" is set, the time will be 500ms. When "100" or less is set, the time will be 100ms.

---Setting range---

0 to 9999 (ms)

【#3070】 syprt Phase synchronization alignment speed

Set the amount of speed fluctuation of synchronous spindle during spindle phase synchronization control. Set this as a proportion to commanded speed.

When "0" is set, the amount will be 5%.

---Setting range---

0 to 100 (%)

【#3071(PR)】 SscDrSelSp Speed monitor Door selection

Select a door group of the speed monitoring to which the axis belongs.
The correspondence between the door signals and bits are as follows.

bit0: Door 1 group
bit1: Door 2 group
bit2: Door 3 group
bit3: Door 4 group

Several door groups can be set.

* When "0000", the axis belongs to door 1 group.

(Note) The speed monitoring is enabled when "SP229/bitF=1".

【#3072(PR)】 Ssc Svof Filter Sp Speed monitor Error detection time during servo OFF

Set the error detection time for when an error of command speed monitoring or feedback speed monitoring is detected during servo OFF.

The alarm will occur if actual speed exceeds safe speed or safe rotation speed for a period of time longer than this setting.

When "0" is set, the detection time will be 200 (ms).

(Note) Speed monitoring function is validated when "SP229/bitF=1".

---Setting range---

0 to 9999 (ms)

【#3078】 spLoad Spindle load display selection

Select a parameter to convert the spindle load (short-time rating) to the spindle load (continuous rating).

0: Parameter #3079 IBRevCt to #3096 hPowAc

1: Parameter #3174 IBRevCt2 to #3191 hPowAc2

(Note) When the setting of the continuous rated data or short-time rated data includes "0", the spindle load (continuous rating) will be "0".

【#3079】 IBRevCt L coil continuous base rotation speed

Set the L coil continuous base rotation speed.

[Property of power and rotation speed in steady state]

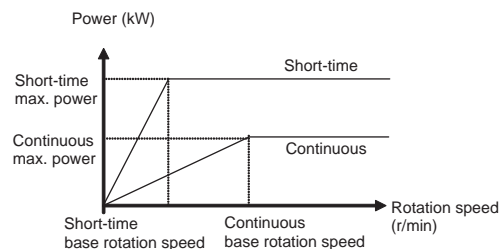

(Note) Refer to the spindle motor's specifications when setting the parameters from #3079 to #3096.

(Note) Use the H coil parameter setting when the coil switch function is not provided.

---Setting range---

0 to 99999 (r/min)

【#3080】 IPowCt L coil continuous maximum power

Set the L coil continuous maximum power at the 0.01kW level.

(Example) Enter "275" to set 2.75kW.

---Setting range---

0 to 65535 (to be converted to 0.01kW level)

【#3081】 IBRevSt L coil short-time base rotation speed

Set the L coil short-time base rotation speed.

---Setting range---

0 to 99999 (r/min)

【#3082】 IPowSt L coil short-time maximum power

Set the L coil short-time maximum power at the 0.01kW level.

---Setting range---

0 to 65535 (to be converted to 0.01kW level)

【#3083】 IBRevAc L coil instantaneous base rotation speed (at acceleration/deceleration)

Set the L coil instantaneous base rotation speed at acceleration/deceleration.
If the spindle motor's specifications have no property of acceleration/deceleration, set "0".

[Property of power and rotation speed at acceleration/deceleration]

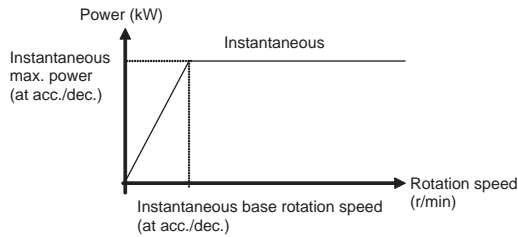
**---Setting range---**

0 to 99999 (r/min)

【#3084】 IPowAc L coil instantaneous maximum power (at acceleration/deceleration)

Set the L coil instantaneous maximum power (at the 0.01kW level) at acceleration/deceleration.
If the spindle motor's specifications have no property of acceleration/deceleration, set "0".

---Setting range---

0 to 65535 (to be converted to 0.01kW level)

【#3085】 mBRevCt M coil continuous base rotation speed

Set the M coil continuous base rotation speed.

(Note) Use the H coil parameter setting when the coil switch function is not provided.

---Setting range---

0 to 99999 (r/min)

【#3086】 mPowCt M coil continuous maximum power

Set the M coil continuous maximum power at the 0.01kW level.

---Setting range---

0 to 65535 (to be converted to 0.01kW level)

【#3087】 mBRevSt M coil short-time base rotation speed

Set the M coil short-time base rotation speed.

---Setting range---

0 to 99999 (r/min)

【#3088】 mPowSt M coil short-time maximum power

Set the M coil short-time maximum power at the 0.01kW level.

---Setting range---

0 to 65535 (to be converted to 0.01kW level)

【#3089】 mBRevAc M coil instantaneous base rotation speed (at acceleration/deceleration)

Set the M coil instantaneous base rotation speed at acceleration/deceleration.

If the spindle motor's specifications have no property of acceleration/deceleration, set "0".

---Setting range---

0 to 99999 (r/min)

【#3090】 mPowAc M coil instantaneous maximum power (at acceleration/deceleration)

Set the M coil instantaneous maximum power (at the 0.01kW level) at acceleration/deceleration. If the spindle motor's specifications have no property of acceleration/deceleration, set "0".

---Setting range---

0 to 65535 (to be converted to 0.01kW level)

【#3091】 hBRevCt H coil continuous base rotation speed

Set the H coil continuous base rotation speed.

(Note) Use the H coil parameter setting when the coil switch function is not provided.

---Setting range---

0 to 99999 (r/min)

【#3092】 hPowCt H coil continuous maximum power

Set the H coil continuous maximum power at the 0.01kW level.

---Setting range---

0 to 65535 (to be converted to 0.01kW level)

【#3093】 hBRevSt H coil short-time base rotation speed

Set the H coil short-time base rotation speed.

---Setting range---

0 to 99999 (r/min)

【#3094】 hPowSt H coil short-time maximum power

Set the H coil continuous maximum power at the 0.01kW level.

---Setting range---

0 to 65535 (to be converted to 0.01kW level)

【#3095】 hBRevAc H coil instantaneous base rotation speed (at acceleration/deceleration)

Set the H coil instantaneous base rotation speed at acceleration/deceleration.

If the spindle motor's specifications have no property of acceleration/deceleration, set "0".

---Setting range---

0 to 99999 (r/min)

【#3096】 hPowAc H coil instantaneous maximum power (at acceleration/deceleration)

Set the H coil instantaneous maximum power (at the 0.01kW level) at acceleration/deceleration.

If the spindle motor's specifications have no property of acceleration/deceleration, set "0".

---Setting range---

0 to 65535 (to be converted to 0.01kW level)

【#3101】 sp_t 1 Acceleration/deceleration time constant with S command (Gear: 00)

Set the acceleration/deceleration time constant with S command (speed operation mode) when gear 00 is selected. Set the linear acceleration/deceleration time up to limit rotation speed (slimit1). Set the short time constant that the motor torque at acceleration is always saturated, however, when an abnormal noise or V-belt slip occurs, increase the time constant.

---Setting range---

0 to 30000 (ms)

【#3102】 sp_t 2 Acceleration/deceleration time constant with S command (Gear: 01)

Set the acceleration/deceleration time constant with S command (speed operation mode) when gear 01 is selected. Set the linear acceleration/deceleration time up to limit rotation speed (slimit2). Set the short time constant that the motor torque at acceleration is always saturated, however, when an abnormal noise or V-belt slip occurs, increase the time constant.

---Setting range---

0 to 30000 (ms)

【#3103】 sp_t 3 Acceleration/deceleration time constant with S command (Gear: 10)

Set the acceleration/deceleration time constant with S command (speed operation mode) when gear 10 is selected. Set the linear acceleration/deceleration time up to limit rotation speed (slimit3). Set the short time constant that the motor torque at acceleration is always saturated, however, when an abnormal noise or V-belt slip occurs, increase the time constant.

---Setting range---

0 to 30000 (ms)

【#3104】 sp_t 4 Acceleration/deceleration time constant with S command (Gear: 11)

Set the acceleration/deceleration time constant with S command (speed operation mode) when gear 11 is selected. Set the linear acceleration/deceleration time up to limit rotation speed (slimit4). Set the short time constant that the motor torque at acceleration is always saturated, however, when an abnormal noise or V-belt slip occurs, increase the time constant.

---Setting range---

0 to 30000 (ms)

【#3105】 sut Speed reach range

Set the speed deviation rate with respect to the commanded speed, at which the speed reach signal will be output.

It will be 15% when set to "0".

If the speed deviation is smaller than 45r/min, it will be set as 45r/min.

---Setting range---

0 to 100 (%)

【#3106】 zrn_typ Zero point return specifications

Select the zero point return specification.

Functions are allocated to each bit.

Set this in hexadecimal format.

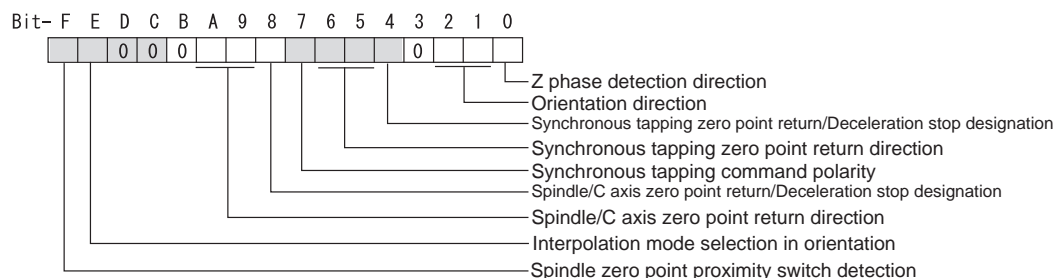
**bit F : Spindle zero point detection with contactless switch**

0: Normal 1: Enable spindle zero point detection using proximity switch

bit E : Control mode selection in orientation

Select non-interpolation mode when vibration occurs since the gain is high during the orientation.

0: Interpolation mode (Use the interpolation mode gain "SP002".)

1: Non-interpolation mode (Use the non-interpolation mode gain "SP001")

bit D-B :

Not used. Set to "0".

bit A-9 : Spindle/C axis zero point return direction

bitA,9=

00: Short-cut

01: Forward run

10: Reverse run

bit 8 : Designate zero point return/deceleration stop of spindle/C axis

0: Zero point return 1: Deceleration stop

bit 7 : Synchronous tapping command polarity

0: Forward direction

1: Reverse direction (The standard setting when spindle and motor are directly coupled)

bit 6-5 : Synchronous tapping zero point return direction

bit 6,5=

00: Short-cut

01: Forward run

10: Reverse run

bit 4 : Designate zero point return

0: Automatically return to zero point before synchronous tapping is started (tapping phase alignment)

1: Not return to zero point and immediately synchronous tapping is started

bit 3 :

Not used. Set to "0".

bit 2-1 : Orientation direction

bit 2,1=

00: Short-cut

01: Forward run

10: Reverse run

bit 0 : Z phase detection direction

0: Forward direction 1: Reverse direction

【#3107】 ori_spd Orientation command speed

Set the spindle speed during orientation command.
 When the spindle is not running or running to the different direction with the orientation, the orientation is carried out with this speed after a stop. When the spindle is running to the same direction with the orientation, this parameter does not have a meaning because it decelerates directly and the orientation is carried out.

---Setting range---
 1 to 99999 (r/min)

【#3108】 ori_sft Position shift amount for orientation

The orientation stop position can be moved by this parameter setting although normally the position is Z -phase position.
 During multi-point orientation control, the stop position is determined by the total value of this parameter and the position data for multi-point orientation of PLC input.

---Setting range---
 -35999 to 35999 (0.01°)

【#3109】 zdetspd Z phase detection speed

For the first S command after power is turned ON, the spindle rotates at the speed of setting value for this parameter until Z phase is detected twice.
 When S command speed (speed operation mode) is smaller than this parameter setting value, the spindle rotates at the S command speed.
 When "#3106/bitF = 1" (Spindle zero point proximity switch detection enabled), also proximity switch is detected.

(Note)When spindle zero point proximity switch detection is enabled, the rotation direction of the orientation/zero point return (synchronous tapping, spindle/C axis) follows Z phase detection direction. The speed follows Z phase detection speed.

---Setting range---
 1 to 99999 (r/min)

【#3110】 tap_spd Synchronous tapping zero point return speed

Set the zero point return speed during synchronous tapping control.

---Setting range---
 1 to 99999 (r/min)

【#3111】 tap_sft Synchronous tapping zero point return shift amount

Set the zero point return shift amount during synchronous tapping control. Zero point angle shifts from Z phase according to the setting angle.

---Setting range---
 0 to 35999 (0.01°)

【#3112】 cax_spd Spindle C axis zero point return speed

Set the zero point return speed during spindle C axis control.

---Setting range---
 1 to 99999 (r/min)

【#3113】 cax_sft Spindle C axis zero point return shift amount

Set the spindle C axis zero point return shift amount. Zero point angle shifts from Z phase according to the setting angle.

---Setting range---
 0 to 359999 (0.001°)

[#3114] cax_para_chg Spindle/C axis parameter switch

Parameter switches when switching the detector system between normal spindle control and C axis control, such as using spindle side detector only for C axis control in spindle drive system. It is validated with replacing a certain servo parameter of the corresponding servo axis to a spindle parameter.

0: Not switch
1: Switch

---Setting range---

0/1 (Standard: 0)

[#3115] sp2_t1 Time constant in orientation/position loop reference position return (Gear: 00)

Set the linear acceleration/deceleration time constant for zero point return control (#3106/bit4,8) which is automatically started at the time of switching orientation control, C axis control and synchronous tapping control when gear 00 is selected. The inclination is determined by the ratio to limit rotation speed (slimit1). Set the sufficiently large value compared to the acceleration/deceleration time constant with S command (sp_t1) so that the output torque is not saturated. When "#1226/bit3=1" and "#3106/bit8=1", C axis zero point return operation depends on the axis specifications parameters.

---Setting range---

0 to 30000 (ms)

[#3116] sp2_t2 Time constant in orientation/position loop reference position return (Gear: 01)

Set the linear acceleration/deceleration time constant for zero point return control (#3106/bit4,8) which is automatically started at the time of switching orientation control, C axis control and synchronous tapping control when gear 01 is selected. The inclination is determined by the ratio to limit rotation speed (slimit2). Set the sufficiently large value compared to the acceleration/deceleration time constant with S command (sp_t2) so that the output torque is not saturated. When "#1226/bit3=1" and "#3106/bit8=1", C axis zero point return operation depends on the axis specifications parameters.

---Setting range---

0 to 30000 (ms)

[#3117] sp2_t3 Time constant in orientation/position loop reference position return (Gear: 10)

Set the linear acceleration/deceleration time constant for zero point return control (#3106/bit4,8) which is automatically started at the time of switching orientation control, C axis control and synchronous tapping control when gear 10 is selected. The inclination is determined by the ratio to limit rotation speed (slimit3). Set the sufficiently large value compared to the acceleration/deceleration time constant with S command (sp_t3) so that the output torque is not saturated. When "#1226/bit3=1" and "#3106/bit8=1", C axis zero point return operation depends on the axis specifications parameters.

---Setting range---

0 to 30000 (ms)

[#3118] sp2_t4 Time constant in orientation/position loop reference position return (Gear: 11)

Set the linear acceleration/deceleration time constant for zero point return control (#3106/bit4,8) which is automatically started at the time of switching orientation control, C axis control and synchronous tapping control when gear 11 is selected. The inclination is determined by the ratio to limit rotation speed (slimit4). Set the sufficiently large value compared to the acceleration/deceleration time constant with S command (sp_t4) so that the output torque is not saturated. When "#1226/bit3=1" and "#3106/bit8=1", C axis zero point return operation depends on the axis specifications parameters.

---Setting range---

0 to 30000 (ms)

【#3119】 ext_clp External spindle speed clamp feedrate

Set the external spindle speed clamp feedrate.
This parameter value will be applied instead of the setting in #3107, #3109, #3110, and #3112 when the external spindle speed clamp signal is ON.

---Setting range---
0 to 99999 (r/min)

【#3120】 staptr Time constant reduction rate in high-speed synchronous tapping

When performing high-speed synchronous tapping control(#1281/bit5), set the reduction rate of the time constant compared to the time constant in normal synchronous tapping.
(Setting "0" or "100" will be regarded as reduction rate zero, so the time constant won't be reduced.)
E.g.) When set to "10", time constant in high-speed synchronous tapping will be 90% of that in normal synchronous tapping.

---Setting range---
0 to 100(%)

【#3121】 tret Turret indexing

Select the validity of turret indexing.
0: Invalid
1: Valid

【#3122】 GRC Turret side gear ratio

Set the number of teeth on the turret side when the gear selection command (control input 4/bit6, 5) is set to 00. Set a value of GRC so that the ratio of GRC to the spindle side gear ratio (#13057 SP057) will be 1:N (an integer).
If GRC is set to "0", it will be regarded as "1".

---Setting range---
0 to 32767

【#3123】 tret_spd Turret indexing speed

Set the turret end indexing speed when in turret indexing.
When this parameter is set to 0, it follows the value set for Orientation command speed (#3107).

---Setting range---
0 to 32767(r/min)

【#3124】 tret_t Turret indexing time constant

Set the acceleration/deceleration time constant to reach Limit rotation speed (slimt1) at gear 00 when in turret indexing. Set this parameter to a larger value than time constant in orientation (#3115).

---Setting range---
0 to 30000 (ms)

【#3125】 tret_inpos Turret indexing in-position width

Set the position error range in which the index positioning complete signal is output when in turret indexing. When this parameter is set to 0, the value of In-position width (#13024 SP024) will be used for this width.

---Setting range---
0 to 32767(1°/1000)

【#3126】 tret_fin_off Index positioning complete signal OFF time

Set the time to forcedly turn OFF the index positioning complete signal since the indexing start signal turns ON. If this period of time has not passed yet, the index positioning complete signal will not turn ON even at the completion of index positioning.

---Setting range---
0 to 10000 (ms)

【#3127】 SPECSP Spindle specification**bit0: Select the gear changeover method.**

- 0: Gear change type 1 (Gear is changed when the spindle stop signal is ON and when a gear recommended by NC and the one selected are different)
- 1: Gear change type 2 (Gear is changed when the spindle stop signal and spindle gear shift signal is ON)

---Setting range---

0x0000 to 0xffff (hexadecimal)

【#3128】 ori_spec Orientation control specification**bit0: Orientation imposition advance output**

- Reduce the orientation time by detecting an in-position faster.
The in-position detection width is changed from SP024(#13024) to ori_inp2.
- 0: Invalid
 - 1: Valid

---Setting range---

0x0000 to 0xffff (hexadecimal)

【#3129】 cax_spec Spindle/C axis control specification

Not used. Set to "0000".

【#3130】 syn_spec Spindle synchronization control specification**bit0: Tool spindle synchronization II (hobbing) automatic compensation selection**

- 0: No compensation.
- 1: Compensate hobbing axis delay (advance) with workpiece axis.

【#3131】 tap_spec Synchronous tapping control specification

Not used. Set to "0000".

【#3132】 ori_inp2 2nd in-position width for orientation

Set the in-position width when imposition advance output control (#3128/bit0) is valid. Reduce the orientation time by setting a bigger value than the value of conventional SP024 and detecting an in-position faster.
Conventional SP024 is used for 2nd in-position signal detection width.

---Setting range---

0 to 32767 (1deg/1000)

【#3133】 spherr Hobbing axis delay (advance) allowable angle

Set the allowable angle between the commanded position and actual position of hobbing axis when it is in tool spindle synchronization II (hobbing) mode (X18AE ON), and also when hobbing axis and workpiece axis are synchronizing (X18A9 ON).

---Setting range---

0 to 32767 (1deg/1000)

【#3134】 sphtc Primary delay time constant for hobbing axis automatic compensation

Set the primary delay time constant of hobbing axis automatic compensation primary delay filter control in tool spindle synchronization II (hobbing).
When set to 0, primary delay filter control is invalid.

---Setting range---

0 to 32767 (ms)

【#3135】 sfwd_g Feed forward gain for hobbing axis

Set the feed forward gain for the hobbing axis in tool spindle synchronization II (hobbing) mode.

---Setting range---

0 to 200 (%)

【#3137】 stap_ax_off High-speed synchronous tapping disabled axis

Set the high-speed synchronous tapping disabled servo axis with bits.

bit0 to bitF : high-speed synchronous tapping disabled axis (1: disable, 0: enable)

If communication between drive units is disabled for a certain axis, set the axis's bits of all the spindles as disabled.

If communication between drive units is disabled for a certain spindle, set all the bits of the spindle as disabled (0xFFFF).

(Note) Each bit (bit0 -) corresponds to the order of the axis name parameter (#1013 axname) setting.

【#3138】 motor_type Spindle motor type

Set the spindle motor type. The set type will be displayed on the drive monitor screen, and it will be also output to the system configuration data.

---Setting range---

Character string within 26 characters including A-Z, a-z, 0-9, "." (decimal point), "-" (hyphen), "/" (slash)

(Cleared by inputting "0".)

【#3140(PR)】 S_DINSp Speed observation input door No.

Set the door signal input in the drive unit.

Use this parameter only when the axis with a door signal belongs to several door groups.

The correspondence between the door signals and bits are as follows.

0000: No signal

0001: Door 1 group.

0002: Door 2 group.

0004: Door 3 group.

0008: Door 4 group.

Set to "0" for an axis without door signal.

When "0" is set even with door signal, follow #3071.

Several bits can not be selected.

A door signals set to #2118 can be set for #3071.

---Setting range---

0000 to 0008(HEX)

【#3141(PR)】 spsscfeed1 Observation speed 1

Set the observation speed, which is at the machine end, in the multi-step speed monitor.

(Note) When the setting value is larger than 18000, the last 2 digits will be ignored.

Ex. 1234567 -> 1234500(°/min)

---Setting range---

0 to 6553500 (°/min)

【#3142(PR)】 spsscfeed2 Observation speed 2

Set the observation speed, which is at the machine end, in the multi-step speed monitor.

(Note) When the setting value is larger than 18000, the last 2 digits will be ignored.

Ex. 1234567 -> 1234500(°/min)

---Setting range---

0 to 6553500 (°/min)

【#3143(PR)】 spsscfeed3 Observation speed 3

Set the observation speed, which is at the machine end, in the multi-step speed monitor.

(Note) When the setting value is larger than 18000, the last 2 digits will be ignored.

Ex. 1234567 -> 1234500(°/min)

---Setting range---

0 to 6553500 (°/min)

【#3144(PR)】 spsscfeed4 Observation speed 4

Set the observation speed, which is at the machine end, in the multi-step speed monitor.

(Note) When the setting value is larger than 18000, the last 2 digits will be ignored.

Ex. 1234567 -> 1234500(°/min)

---Setting range---

0 to 6553500 (°/min)

【#3145(PR)】 S_SigInSP Safety observation signal input

This parameter specifies which safety observation signal is input in the drive unit.

Safety observation signal corresponds to the following parameter bits.

bit0: Connected to safety observation signal 1

bit1: Connected to safety observation signal 2

bit2: Connected to safety observation signal 3

Set "0000" for axes without inputting safety observation signal.

(Note)When a same set value is set for several axes and several bits can be enabled for an axis, the alarm "Y20 0027" occurs.

---Setting range---

0000 to 0004 (HEX)

【#3149(PR)】 spsscfeed5 Observation speed 5

Set the observation speed, which is at the machine end, in the multi-step speed monitor.

(Note)When the setting value is larger than 18000, the last two digits will be ignored.

Ex. 1234567 -> 1234500(°/min)

---Setting range---

0 to 6553500 (°/min)

【#3150(PR)】 spsscfeed6 Observation speed 6

Set the observation speed, which is at the machine end, in the multi-step speed monitor.

(Note)When the setting value is larger than 18000, the last two digits will be ignored.

Ex. 1234567 -> 1234500(°/min)

---Setting range---

0 to 6553500 (°/min)

【#3151(PR)】 spsscfeed7 Observation speed 7

Set the observation speed, which is at the machine end, in the multi-step speed monitor.

(Note)When the setting value is larger than 18000, the last two digits will be ignored.

Ex. 1234567 -> 1234500(°/min)

---Setting range---

0 to 6553500 (°/min)

【#3152(PR)】 spsscfeed8 Observation speed 8

Set the observation speed, which is at the machine end, in the multi-step speed monitor.

(Note)When the setting value is larger than 18000, the last two digits will be ignored.

Ex. 1234567 -> 1234500(°/min)

---Setting range---

0 to 6553500 (°/min)

【#3153】 cms1 Spindle viscous friction coefficient 1

Set a viscous friction coefficient for spindle.

This parameter is to estimate the cutting torque of spindle.

#13018(SP018)/bit5=0: Mechanical gear 1-step

#13018(SP018)/bit5=1: Coil changeover H

---Setting range---

0 to ± 9999999 (0.00001%/rpm)

【#3154】 cms2 Spindle viscous friction coefficient 2

Set a viscous friction coefficient for spindle.
 This parameter is to estimate the cutting torque of spindle.
 #13018(SP018)/bit5=0: Mechanical gear 2-step
 #13018(SP018)/bit5=1: Coil changeover L

---Setting range---
 0 to ± 9999999 (0.00001%/rpm)

【#3155】 cms3 Spindle viscous friction coefficient 3

Set a viscous friction coefficient for spindle.
 This parameter is to estimate the cutting torque of spindle.
 #13018(SP018)/bit5=0: Mechanical gear 3-step
 #13018(SP018)/bit5=1: Coil changeover Not use

---Setting range---
 0 to ± 9999999 (0.00001%/rpm)

【#3156】 cms4 Spindle viscous friction coefficient 4

Set a viscous friction coefficient for spindle.
 This parameter is to estimate the cutting torque of spindle.
 #13018(SP018)/bit5=0: Mechanical gear 4-step
 #13018(SP018)/bit5=1: Coil changeover Not use

---Setting range---
 0 to ± 9999999 (0.00001%/rpm)

【#3157】 fms1 Spindle coulomb friction coefficient 1

Set a coulomb friction coefficient for spindle.
 This parameter is to estimate the cutting torque of spindle.
 #13018(SP018)/bit5=0: Mechanical gear 1-step
 #13018(SP018)/bit5=1: Coil changeover H

---Setting range---
 0 to ± 9999999 (0.00001%/Nm)

【#3158】 fms2 Spindle coulomb friction coefficient 2

Set a coulomb friction coefficient for spindle.
 This parameter is to estimate the cutting torque of spindle.
 #13018(SP018)/bit5=0: Mechanical gear 2-step
 #13018(SP018)/bit5=1: Coil changeover L

---Setting range---
 0 to ± 9999999 (0.00001%/Nm)

【#3159】 fms3 Spindle coulomb friction coefficient 3

Set a coulomb friction coefficient for spindle.
 This parameter is to estimate the cutting torque of spindle.
 #13018(SP018)/bit5=0: Mechanical gear 3-step
 #13018(SP018)/bit5=1: Coil changeover Not use

---Setting range---
 0 to ± 9999999 (0.00001%/Nm)

【#3160】 fms4 Spindle coulomb friction coefficient 4

Set a coulomb friction coefficient for spindle.
 This parameter is to estimate the cutting torque of spindle.
 #13018(SP018)/bit5=0: Mechanical gear 4-step
 #13018(SP018)/bit5=1: Coil changeover Not use

---Setting range---
 0 to ± 9999999 (0.00001%/Nm)

【#3164(PR)】 sscSpSpec Safety observation specification selection

Select a specification of safety observation.

bit0: Constant speed observation

The speed observation is constantly enabled.

0: Speed observation is constantly disabled.

1: Speed observation is constantly enabled.

(Note)Axes connected with Door1 to Door4 cannot be constantly observed. (Setting error alarm for the parameter of constant speed observation)

【#3165(PR)】 sscCntFedSp Observation speed for constant speed monitor

Set the observation speed, which is at the machine end, in the multi-step speed monitor.

(Note)When the setting value is larger than 18000, the last two digits will be ignored.

Ex. 1234567 -> 1234500(°/min)

---Setting range---

0 to 6553500 (°/min)

【#3172】 sp_speed_dsp_fil Spindle rotation speed display data filter

Set the average frequency to filter the spindle rotation speed display data.

When "0" is set, filtering is not performed.

---Setting range---

0 to 64

【#3173】 sp_load_dsp_fil Spindle load meter display data filter(for special display unit)

Set the average frequency to filter the spindle load meter display data.

When "0" is set, filtering is not performed.

---Setting range---

0 to 64

【#3174】 IBRevCt2 L coil continuous base rotation speed 2

Set the L coil continuous base rotation speed.

(Note) Refer to the figure of #3079 for #3174 to #3191.

(Note) Use the H coil parameter setting when the coil switch function is not provided.

---Setting range---

0 to 99999(r/min)

【#3175】 IPowCt2 L coil continuous maximum power 2

Set the L coil continuous maximum power at the 0.01kW level.

(Example) Enter "275" to set 2.75kW.

---Setting range---

0 to 65535(0.01kW)

【#3176】 IBRevSt2 L coil short-time base rotation speed 2

Set the L coil short-time base rotation speed.

---Setting range---

0 to 99999(r/min)

【#3177】 IPowSt2 L coil short-time maximum power 2

Set the L coil short-time maximum power at the 0.01kW level.

---Setting range---

0 to 65535(0.01kW)

【#3178】 IBRevAc2 L coil instantaneous base rotation speed 2 (at acceleration/deceleration)

Set the L coil instantaneous base rotation speed at acceleration/deceleration.

---Setting range---

0 to 99999(r/min)

【#3179】 IPowAc2 L coil instantaneous maximum power 2 (at acceleration/deceleration)

Set the L coil instantaneous maximum power (at the 0.01kW level) at acceleration/deceleration.

---Setting range---
0 to 65535(0.01kW)

【#3180】 mBRevCt2 M coil continuous base rotation speed 2

Set the M coil continuous base rotation speed.
(Note) Use the H coil parameter setting when the coil switch function is not provided.

---Setting range---
0 to 99999(r/min)

【#3181】 mPowCt2 M coil continuous maximum power 2

Set the M coil continuous maximum power at the 0.01kW level.

---Setting range---
0 to 65535(0.01kW)

【#3182】 mBRevSt2 M coil short-time base rotation speed 2

Set the M coil short-time base rotation speed.

---Setting range---
0 to 99999(r/min)

【#3183】 mPowSt2 M coil short-time maximum power 2

Set the M coil short-time maximum power at the 0.01kW level.

---Setting range---
0 to 65535(0.01kW)

【#3184】 mBRevAc2 M coil instantaneous base rotation speed 2 (at acceleration/deceleration)

Set the M coil instantaneous base rotation speed at acceleration/deceleration.

---Setting range---
0 to 99999(r/min)

【#3185】 mPowAc2 M coil instantaneous maximum power 2 (at acceleration/deceleration)

Set the M coil instantaneous maximum power (at the 0.01kW level) at acceleration/deceleration.

---Setting range---
0 to 65535(0.01kW)

【#3186】 hBRevCt2 H coil continuous base rotation speed 2

Set the H coil continuous base rotation speed.
(Note) Use the H coil parameter setting when the coil switch function is not provided.

---Setting range---
0 to 99999(r/min)

【#3187】 hPowCt2 H coil continuous maximum power 2

Set the H coil continuous maximum power at the 0.01kW level.

---Setting range---
0 to 65535(0.01kW)

【#3188】 hBRevSt2 H coil short-time base rotation speed 2

Set the H coil short-time base rotation speed.

---Setting range---
0 to 99999(r/min)

【#3189】 hPowSt2 H coil short-time maximum power 2

Set the H coil short-time maximum power at the 0.01kW level.

---Setting range---
0 to 65535(0.01kW)

【#3190】 hBRevAc2 H coil instantaneous base rotation speed 2 (at acceleration/deceleration)

Set the H coil instantaneous base rotation speed at acceleration/deceleration.

---Setting range---
0 to 99999(r/min)

【#3191】 hPowAc2 H coil instantaneous maximum power 2 (at acceleration/deceleration)

Set the H coil instantaneous maximum power (at the 0.01kW level) at acceleration/deceleration.

---Setting range---
0 to 65535(0.01kW)

【#13001】 SP001 PGV Position loop gain non-interpolation mode

Set the position loop gain for "Non-interpolation" control mode.

When the setting value increases, the command tracking ability will enhance and the positioning settling time can be shorter. However, the impact on the machine during acceleration/deceleration will increase.

Use the selection command, the control mode "bit 2, 1, 0 = 000" in control input 4.

(Note) The control mode is commanded by NC.

---Setting range---
1 to 200 (1/s)

【#13002】 SP002 PGN Position loop gain interpolation mode

Set the position loop gain for "interpolation" control mode.

When the setting value increases, the command tracking ability will enhance and the positioning settling time can be shorter. However, the impact on the machine during acceleration/deceleration will increase.

Use the selection command, the control mode "bit 2, 1, 0 = 010 or 100" in control input 4.

(Note) The control mode is commanded by NC.

When carrying out the SHG control, set SP035/bitC to "1".

---Setting range---
1 to 200 (1/s)

【#13003】 SP003 PGS Position loop gain spindle synchronization

Set the position loop gain for "spindle synchronization" control mode.

When the setting value increases, the command tracking ability will enhance and the positioning settling time can be shorter. However, the impact on the machine during acceleration/deceleration will increase.

Use the selection command, the control mode "bit 2, 1, 0 = 001" in control input 4.

(Note) The control mode is commanded by NC.

When carrying out the SHG control, set SP036/bit4 to "1".

---Setting range---
1 to 200 (1/s)

【#13004】 SP004

Not used. Set to "0".

【#13005】 SP005 VGN1 Speed loop gain 1

Set the speed loop gain.
 Set this according to the load inertia size.
 The higher setting value will increase the accuracy of control, however, vibration tends to occur.
 If vibration occurs, adjust by lowering by 20 to 30%.
 The final value should be 70 to 80% of the value at which the vibration stops.

---Setting range---
 1 to 9999

【#13006】 SP006 VIA1 Speed loop lead compensation 1

Set the speed loop integral control gain.
 The standard setting is "1900". Adjust the value by increasing/decreasing the value by about 100.
 Raise this value to improve the contour tracking accuracy in high-speed cutting.
 Lower this value when the position droop does not stabilize (when the vibration of 10 to 20Hz occurs).

---Setting range---
 1 to 9999

【#13007】 SP007 VIL1 Speed loop delay compensation 1

Set this parameter when the limit cycle occurs in the full-closed loop or overshooting occurs in positioning.
 When setting this parameter, make sure to set the torque offset "SP050(TOF)".
 When not using, set to "0".

---Setting range---
 0 to 32767

【#13008】 SP008 VGN2 Speed loop gain 2

Normally SP005(VGN1) is used.
 By setting "SP035/bit1, SP035/bit9 or SP036/bit1=1", gain 2 can be used according to the application.
 Gain 2 can also be used by setting "Speed gain set 2 changeover request (control input 5/ bitC) = 1".
 Refer to SP005(VGN1) for adjustment procedures.

---Setting range---
 1 to 9999

【#13009】 SP009 VIA2 Speed loop lead compensation 2

Normally SP006(VIA1) is used.
 By setting "SP035/bit1, SP035/bit9 or SP036/bit1=1", gain 2 can be used according to the application.
 Gain 2 can also be used by setting "Speed gain set 2 changeover request (control input 5/ bitC) = 1".
 Refer to SP006(VIA1) for adjustment procedures.

---Setting range---
 1 to 9999

【#13010】 SP010 VIL2 Speed loop delay compensation 2

Normally SP007(VIL1) is used.
 By setting "SP035/bit1, SP035/bit9 or SP036/bit1=1", gain 2 can be used according to the application.
 Gain 2 can also be used by setting "Speed gain set 2 changeover request (control input 5/ bitC) = 1".
 Refer to SP007(VIL1) for adjustment procedures.

---Setting range---
 0 to 32767

【#13011】 SP011

Not used. Set to "0".

【#13012】 SP012

Not used. Set to "0".

【#13013】 SP013

Not used. Set to "0".

【#13014】 SP014 PY1 Minimum excitation rate 1

Set the minimum value for the variable excitation rate. The standard setting is "50".

Set to "0" when using an IPM spindle motor.

If noise including gear noise is loud, select a small value. However, a larger setting value is more effective for impact response.

(Note) When setting a value at "50 or more", check if there is no problem with gear noise, motor excitation noise, vibration during low-speed rotation or vibration when the servo is locked during orientation stop, etc.

When setting a value at "less than 50", check if there is no problem with the impact load response or rigidity during servo lock.

---Setting range---

0 to 100 (%)

【#13015】 SP015 PY2 Minimum excitation rate 2

Normally, SP014(PY1) is used.

By setting "SP035/bit2, SP035/bitA or SP036/bit2=1", the excitation rate 2 can be used according to the application.

The excitation rate 2 can also be used by setting "the minimum excitation rate 2 changeover request (control input 5/ bitB) = 1". Refer to SP014(PY1) for adjustment procedures.

Set to "0" when using an IPM spindle motor.

---Setting range---

0 to 100 (%)

【#13016】 SP016 DDT Phase alignment deceleration rate

Set the single-rotation position alignment deceleration rate for orientation stopping, phase alignment while rotating and switching from non-interpolation mode to spindle synchronization mode while rotating.

When the load inertia is larger, the setting value should be smaller.

When the setting value is larger, the orientation in-position and single-rotation position alignment complete faster, but the impact applied on the machine will increase.

To change the deceleration rate only during rotation command (command F Δ T ≠ 0), set this parameter together with SP070 (KDDT).

---Setting range---

1 to 32767 (0.1(r/min)/ms)

【#13017(PR) SP017 SPEC1 Spindle specification 1

Select the spindle specification.
 A function is allocated to each bit.
 Set this in hexadecimal format.

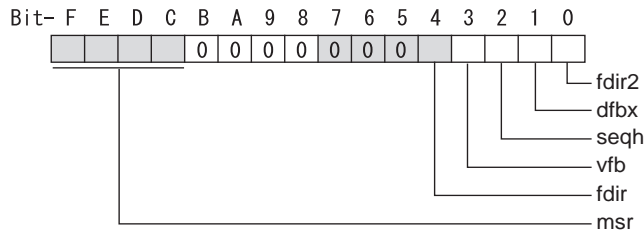

bit F-C : msr Motor series selection

- 0: 200V specification IM spindle motor
- 1: 200V specification IPM spindle motor
- 2: 400V specification IM spindle motor
- 3: 400V specification IPM spindle motor
- 4: 200V specification Tool spindle motor

bit B-5 :

Not used. Set to "0".

bit 4 : fdir Position feedback

Set the machine side detector's installation polarity.
 0: Forward polarity 1: Reverse polarity

bit 3 : vfb Speed feedback filter

0: Disable 1: Enable (2250Hz)

bit 2 : seqh READY ON sequence

0: Normal 1: High-speed

bit 1 : dfbx Dual feedback control

Control the position FB signal in full closed control by the combination of a motor side detector and machine side detector.
 0: Stop 1: Start

Related parameters: SP051, SP052

bit 0 : fdir2 Speed feedback polarity

Set the motor side detector's installation polarity by a built-in motor.
 0: Forward polarity 1: Reverse polarity

【#13018(PR)】 SP018 SPEC2 Spindle specification 2

Select the spindle specification.
A function is allocated to each bit.
Set this in hexadecimal format.

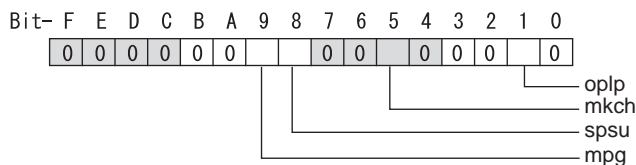
**bit F-A :**

Not used. Set to "0".

bit 9 : mpg Earth fault detection

0: Disable 1: Enable (standard)
Set "0" and it is constantly "Enable" for MDS-DJ-SP Series.

bit 8 : spsu Command speed limit value

0: 33,750 r/min 1: 135,000 r/min

bit 7-6 :

Not used. Set to "0".

bit 5 : mkch Coil switch function

0: Disable 1: Enable

bit 4-2 :

Not used. Set to "0".

bit 1 : oplp Open loop control

This allows the operation in which no detector feedback signals are used.
It is used when adjusting the detector, etc.
0: Disable 1: Enable

bit 0 :

Not used. Set to "0".

【#13019(PR)】 SP019 RNG1 Sub side detector resolution

[For semi-closed loop]

Set the same value as SP020 (RNG2). (Refer to the explanation of SP020.)

[For full-closed loop]

Set the number of pulses per revolution of the machine side detector.

When using ABZ pulse output detector (OSE-1024-3-15-68), set this combined with SP097(RNG1ex).

SP019 = 4096

SP097 = -1

---Setting range---

When SP097=0, the setting range is from 0 to 32767 (kp)

When SP097 ≠ 0

For M700V, M70V, M70, E70: 0 to 65535 (p)

For C70: -32768 to 32767 (p)

【#13020(PR) SP020 RNG2 Main side detector resolution

Set the number of pulses per revolution of the motor side detector.
When using the detector interface unit MDS-B-HR, use this with SP098(RNG2ex).

Detector

TS5691(128 teeth): SP020 = 2000
TS5691(180 teeth): SP020 = 2880
TS5691(256 teeth): SP020 = 4000
TS5691(384 teeth): SP020 = 6000
TS5691(512 teeth): SP020 = 8000

TS5690(64 teeth): SP020 = 2000
TS5690(90 teeth): SP020 = 2880
TS5690(128 teeth): SP020 = 4000
TS5690(192 teeth): SP020 = 6000
TS5690(256 teeth): SP020 = 8000
TS5690(384 teeth): SP020 =12000

ERM280(1200 teeth): SP020 = 4800
ERM280(2048 teeth): SP020 = 8000

MPCI : SP020 = 7200
MBE205: SP020 = 2000

Tool spindle motor
OSA18(-A48): SP020 = 260

---Setting range---

When SP098=0, the setting range is from 0 to 32767 (kp)
When SP098 ≠ 0
For M700V,M70V,M70,E70: 0 to 65535 (p)
For C70: -32768 to 32767 (p)

【#13021(PR) SP021 OLT Overload detection time constant

Set the detection time constant of Overload 1 (Alarm 50). (For machine tool builder adjustment)
Normally, set to "60".
Set to "300" when using an IPM spindle motor.

---Setting range---

1 to 15300 (s)

【#13022] SP022 OLL Overload detection level

Set the current detection level of "Overload 1" (Alarm 50) as a percentage against the motor short-time rated output current. (For machine tool builder adjustment)
Normally, set to "120".
Set to "100" when using an IPM spindle motor.

---Setting range---

1 to 200 (Short-time rated %)

【#13023] SP023 OD1 Excessive error detection width (interpolation mode - spindle synchronization)

Set the excessive error detection width for the interpolation mode and spindle synchronization.
The standard setting is "120".
When set to "0", the excessive error detection will be ignored, so do not set to "0".

---Setting range---

1 to 32767 (°)

【#13024】 SP024 INP In-position width

Set the in-position detection width.
 Set the positioning accuracy required to the machine.
 Lower setting value increases the positioning accuracy, but makes the cycle time (settling time) longer.
 The standard setting is "875".

---Setting range---
 0 to 32767 (1°/1000)

【#13025】 SP025 INP2 2nd in-position width

Use this when detecting an in-position different from normal in-position width such as advancing the in-position signal. The adjustment procedure is the same as SP024 (INP).
 The standard setting is "875".

---Setting range---
 0 to 32767 (1°/1000)

【#13026(PR)】 SP026 TSP Maximum motor speed

Set the maximum motor speed.
 If the motor speed exceeds the set maximum speed, an overspeed alarm will occur.

---Setting range---
 1 to 32767 (r/min)

【#13027】 SP027 ZSP Motor zero speed

Set the motor speed for detecting zero speed.
 If the motor speed drops below the set speed, the zero speed signal turns ON.
 The standard setting is "50".

---Setting range---
 1 to 1000 (r/min)

【#13028】 SP028 SDTS Speed detection set value

Set the motor speed for detecting the speed.
 If the motor speed drops below the set speed, the speed detection signal turns ON.
 The standard setting is 10% of the maximum motor speed.

---Setting range---
 10 to 32767 (r/min)

【#13029】 SP029 SDTR Speed detection reset width

Set the hysteresis width in which the speed detection changes from ON to OFF.
 If the setting value is small, the speed detection will chatter easily.
 The standard setting is "30".

---Setting range---
 10 to 1000 (r/min)

【#13030】 SP030 SDT2 2nd speed detection setting value

Set the specified speed of the specified speed output.
 When carrying out digital output of the specified speed output, set SP229/bitC to "1".
 It is not available for MDS-DJ-SP Series.

---Setting range---
 0 to 32767 (r/min)

【#13031(PR)】 SP031 MTYP Motor type

Set the control system of the spindle drive unit.
 2200: Semi closed loop control
 4200: Full closed loop control by using spindle side ABZ pulse output detector
 6200: Full closed loop control by using spindle side serial output detector

【#13032(PR)】 SP032 PTP Power supply type/ Regenerative resistor type

MDS-D2/DH2 Series: Power supply type

When connecting a power supply unit, set a code for each power supply unit.

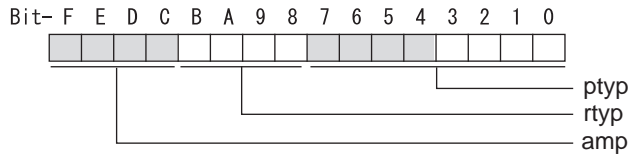

bit F-C : amp

Set the power backup function to be used.
 No function used : 0
 Deceleration and stop function at power failure : 8

bit B-8 : rtp

Not used. Set to "0".

bit 7-0 : pyp External emergency stop setting

When the emergency stop input signal of the power supply unit is "disabled"

- Power supply unit is not connected : 00
- MDS-D2-CV-37 / MDS-DH2-CV-37 : 04
- MDS-D2-CV-75 / MDS-DH2-CV-75 : 08
- MDS-D2-CV-110 / MDS-DH2-CV-110 : 11
- MDS-D2-CV-185 / MDS-DH2-CV-185 : 19
- MDS-D2-CV-300 / MDS-DH2-CV-300 : 30
- MDS-D2-CV-370 / MDS-DH2-CV-370 : 37
- MDS-D2-CV-450 / MDS-DH2-CV-450 : 45
- MDS-D2-CV-550 / MDS-DH2-CV-550 : 55
- MDS-DH2-CV-750 : 75

When the emergency stop input signal of the power supply unit is "enabled"

(Note) Set the power supply rotary switch to "4".

- Power supply unit is not connected : 00
- MDS-D2-CV-37 / MDS-DH2-CV-37 : 44
- MDS-D2-CV-75 / MDS-DH2-CV-75 : 48
- MDS-D2-CV-110 / MDS-DH2-CV-110 : 51
- MDS-D2-CV-185 / MDS-DH2-CV-185 : 59
- MDS-D2-CV-300 / MDS-DH2-CV-300 : 70
- MDS-D2-CV-370 / MDS-DH2-CV-370 : 77
- MDS-D2-CV-450 / MDS-DH2-CV-450 : 85
- MDS-D2-CV-550 / MDS-DH2-CV-550 : 95
- MDS-DH2-CV-750 : B5

MDS-DM2-SPV Series: Power supply type

Set as follows for the spindle drive section of the MDS-DM2-SPV.

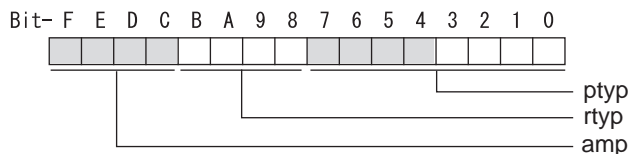

bit F-C : amp

Not used. Set to "0".

bit B-8 : rtp

Not used. Set to "0".

bit 7-0 : pyp External emergency stop setting

- Normal : 19
- External emergency stop function: 59

MDS-DJ-SP Series: Regenerative resistor type

Set the regenerative resistor type.

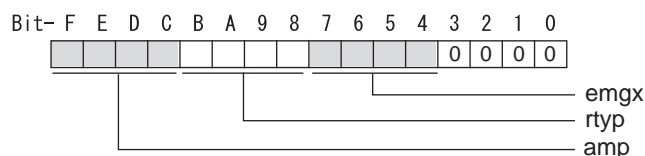
**bit F-8 : amp(bit F-C) / rtp(bit B-8)**

Setting prohibited	: 10-12
MR-RB12 or GZG200W39OHMK	: 13
MR-RB32 or GZG200W120OHMK 3 units connected in parallel	: 14
MR-RB30 or GZG200W39OHMK 3 units connected in parallel	: 15
MR-RB50 or GZG300W39OHMK 3 units connected in parallel	: 16
Setting prohibited	: 17-1F
Setting prohibited	: 20-23
FCUA-RB22	: 24
FCUA-RB37	: 25
FCUA-RB55	: 26
FCUA-RB75/2 1 unit	: 27
R-UNIT1	: 28
R-UNIT2	: 29
R-UNIT3	: 2A
R-UNIT4	: 2B
R-UNIT5	: 2C
FCUA-RB75/2 2 units connected in parallel:	2D
FCUA-RB55/2 2 units connected in parallel:	2E
Setting prohibited	: 2F

bit 7-4 : emgx External emergency stop function

Set the external emergency stop function.
0: Disable 4: Enable

bit 3-0 :

Not used. Set to "0".

【#13033】 SP033 SFNC1 Spindle function 1

Select the spindle specification.
 A function is allocated to each bit.
 Set this in hexadecimal format.

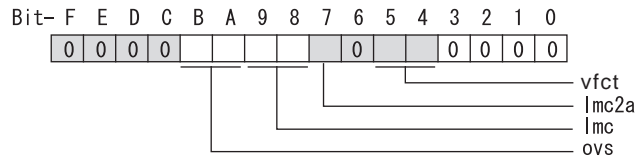

bit F-C :

Not used. Set to "0".

bit B-A : ovs Overshoot compensation

Set this parameter when overshooting occurs during positioning.

- bitB,A=
 00: Compensation stop
 01: Setting prohibited
 10: Setting prohibited
 11: Compensation type 3

Set the compensation amount in SP043(OVS1) and SP042(OVS2).

bit 9-8 : lmc Lost motion compensation type2

Set this parameter when the protrusion at quadrant change is too large.

- bit9,8=
 00: Compensation stop
 01: Setting prohibited
 10: Compensation type 2
 11: Setting prohibited

bit 7 : lmc2a Lost motion compensation 2 timing

- 0: Normal 1: Change

bit 6 :

Not used. Set to "0".

bit 5-4 : vfct Jitter compensation pulse number

Suppress vibration by machine backlash when axis stops.

- bit5,4=
 00: Disable
 01: 1 pulse
 10: 2 pulse
 11: 3 pulses

bit 3-0 :

Not used. Set to "0".

【#13034】 SP034 SFNC2 Spindle function 2

Select the spindle function.
A function is allocated to each bit.
Set this in hexadecimal format.

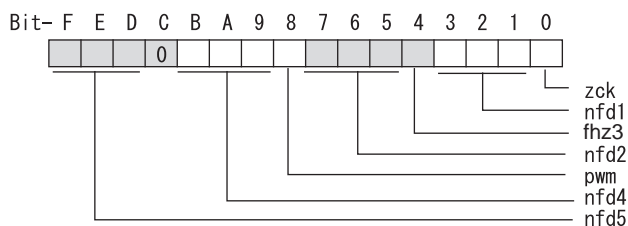
**bit F-D : nfd5 Depth of Notch filter 5**

Set the depth of Notch filter 5 (SP088).

bit F,E,D=

000: -∞

001: -18.1[dB]

010: -12.0[dB]

011: -8.5[dB]

100: -6.0[dB]

101: -4.1[dB]

110: -2.5[dB]

111: -1.2[dB]

bit C :

Not used. Set to "0".

bit B-9 : nfd4 Depth of Notch filter 4

Set the depth of Notch filter 4 (SP087).

bit B,A,9=

000: -∞

001: -18.1[dB]

010: -12.0[dB]

011: -8.5[dB]

100: -6.0[dB]

101: -4.1[dB]

110: -2.5[dB]

111: -1.2[dB]

bit 8 : pwm Current control

0: Standard current control 1: High frequency current control

bit 7-5 : nfd2 Depth of Notch filter 2

Set the depth of Notch filter 2 (SP046).

bit7,6,5=

000: -∞

001: -18.1[dB]

010: -12.0[dB]

011: -8.5[dB]

100: -6.0[dB]

101: -4.1[dB]

110: -2.5[dB]

111: -1.2[dB]

bit 4 : fhz3 Notch filter 3

0: Stop 1: Start (1125Hz)

bit 3-1 : nfd1 Depth of Notch filter 1

Set the depth of Notch filter 1 (SP038).
 bit3,2,1=
 000: - ∞
 001: -18.1[dB]
 010: -12.0[dB]
 011: -8.5[dB]
 100: -6.0[dB]
 101: -4.1[dB]
 110: -2.5[dB]
 111: -1.2[dB]

bit 0 :

Not used. Set to "0".

【#13035(PR) SP035 SFNC3 Spindle function 3

Select the spindle function.
 A function is allocated to each bit.
 Set this in hexadecimal format.

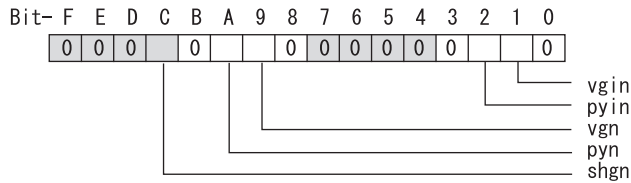

bit F-D :

Not used. Set to "0".

bit C : shgn SHG control in interpolation mode

0: Stop 1: Start
 When using the OMR-FF control, set to "0".

bit B :

Not used. Set to "0".

bit A : pyn Excitation rate selection in interpolation mode

0: Select Excitation rate 1 1: Select Excitation rate 2

bit 9 : vgn Speed loop gain set selection in interpolation mode

0: Select Set 1 1: Select Set 2

bit 8-3 :

Not used. Set to "0".

bit 2 : pyin Excitation rate selection in non-interpolation mode

The excitation rate after the in-position can be selected.
 0: Select Excitation rate 1 1: Select Excitation rate 2

bit 1 : vgin Speed loop gain set selection in non-interpolation mode

The speed loop gain set after the in-position can be selected.
 0: Select Set 1 1: Select Set 2

bit 0 :

Not used. Set to "0".

【#13036(PR)】 SP036 SFNC4 Spindle function 4

Select the spindle function.
A function is allocated to each bit.
Set this in hexadecimal format.

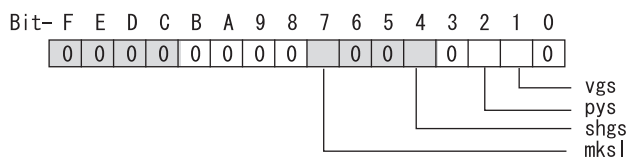
**bit F-8 :**

Not used. Set to "0".

bit 7 : mksl Coil selection in spindle synchronization mode

0: Select the coil commanded during synchronization 1: Select high-speed coil

bit 6-5 :

Not used. Set to "0".

bit 4 : shgs SHG control in spindle synchronization mode

0: Stop 1: Start
When using the OMR-FF control, set to "0".

bit 3 :

Not used. Set to "0".

bit 2 : pys Excitation rate selection in spindle synchronization mode

0: Select Excitation rate 1 1: Select Excitation rate 2

bit 1 : vgs Speed loop gain set selection in spindle synchronization mode

0: Select Set 1 (SP005,SP006,SP007) 1: Select Set 2 (SP008,SP009,SP010)

bit 0 :

Not used. Set to "0".

【#13037】 SP037 JL Load inertia scale

Set the motor axis conversion total load inertia including motor itself in proportion to the motor inertia.

$$SV037(JL) = (J_m + J_l) / J_m \times 100$$

J_m: Motor inertia

J_l: Motor axis conversion load inertia

---Setting range---

0 to 5000 (%)

【#13038】 SP038 FH_z1 Notch filter frequency 1

Set the vibration frequency to suppress when machine vibration occurs.

(Enabled at 50 or more.)

When not using, set to "0".

Related parameters: SP034/bit3-1

---Setting range---

0 to 2250 (Hz)

【#13039】 SP039 LMCD Lost motion compensation timing

Set this parameter when the lost motion compensation type2 timing does not match.

Adjust by increasing the value by 10 at a time.

---Setting range---

0 to 2000 (ms)

【#13040】 SP040 LMCT Lost motion compensation non-sensitive band

Set the non-sensitive band of the lost motion compensation in the feed forward control.
When "0" is set, 2°/1000 is set. Adjust by increasing the value by 1°/1000 at a time.

---Setting range---

-32768 to 32767 (1°/1000)

【#13041】 SP041 LMC2 Lost motion compensation 2

Set this parameter with SP048(LMC1) only to vary the lost motion compensation amount depending on the command directions.
Normally, set to "0".

---Setting range---

-1 to 200 (Short-time rated %)

Note that when SP227/bit2 is "1", the range will be -1 to 20000 (Short-time rated 0.01%).

【#13042】 SP042 OVS2 Overshooting compensation 2

Set this parameter with SP043(OVS1) only to vary the lost motion compensation amount depending on the command directions.
Normally, set to "0".

---Setting range---

-1 to 100 (Short-time rated %)

Note that when SP227/bit2 is "1", the range will be -1 to 10000 (Short-time rated 0.01%).

【#13043】 SP043 OVS1 Overshooting compensation 1

Set this parameter when overshooting occurs during positioning. This compensates the motor torque during positioning.
This is valid only when the overshooting compensation SP033 (SFNC1/ovs) is selected.

[Type 3 "When SP033/ bitB,A=11"]

Use this when performing overshoot compensation in the feed forward control during arc cutting mode.

Set the compensation amount based on the motor short-time rated current.

Increase the value in increments of 1% to find the value where overshooting ceases.

[To vary compensation amount depending on the direction]

When SV042 (OVS2) is "0", change the SP043 (OVS1) value in both +/- directions to compensate.

To change the compensation amount depending on the command direction, set this with SP042 (OVS2).

(SP043: + direction, SP042: - direction, However, the directions may be opposite depending on other settings.)

When "-1" is set, the compensation will not be performed in the command direction.

---Setting range---

-1 to 100 (Short-time rated %)

Note that when SP227/bit2 is "1", the range will be -1 to 10000 (Short-time rated 0.01%).

【#13044】 SP044 OBS2 Disturbance observer gain

Set the disturbance observer gain. The standard setting is "100".

To use the disturbance observer, also set SP037(JL), SP045(OBS1) and SP226/ bitE.

When not using, set to "0".

---Setting range---

0 to 500 (%)

【#13045】 SP045 OBS1 Disturbance observer filter frequency

Set the disturbance observer filter band.

Normally, set to "100".

To use the disturbance observer, also set SP037(JL), SP044(OBS2) and SP226/ bitE.

When not using, set to "0".

---Setting range---

0 to 1000 (rad/s)

【#13046】 SP046 FHz2 Notch filter frequency 2

Set the vibration frequency to suppress when machine vibration occurs.
(Enabled at 50 or more.)
When not using, set to "0".

Related parameters: SP034/bit7-5

---Setting range---

0 to 2250 (Hz)

【#13047】 SP047 EC Inductive voltage compensation gain

Set the inductive voltage compensation gain. Normally, set to "100".
Lower the gain when the current FB peak exceeds the current command peak.

---Setting range---

0 to 200 (%)

【#13048】 SP048 LMC1 Lost motion compensation 1

Set this parameter when the protrusion (that occurs due to the non-sensitive band by friction, torsion, backlash, etc.) at quadrant change is too large.

This sets the compensation torque at quadrant change (when an axis feed direction is reversed) by Short-time rated %.

Whether to enable the lost motion compensation and the method can be set with other parameters.

[Type 2 "When SP033/bit9,8=10"]

Set the compensation amount based on the motor short-time rated current.

The standard setting is double of the friction torque. The compensation amount will be 0 when "0" is set.

Related parameters: SP033/bit9-8, SP039, SP040, SP041, SP227/bit2

[To vary compensation amount depending on the direction]

When SP041 (LMC2) is "0", change SP048 (LMC1) value in both of +/- directions to compensate.

To vary the compensation amount depending on the command direction, set this with SP041 (LMC2).

(SP048: + direction, SP041: - direction, However, the directions may be opposite depending on other settings.)

When "-1" is set, the compensation will not be performed in the command direction.

---Setting range---

-1 to 200 (Short-time rated %)

Note that when SP227/bit2 is "1", the range will be -1 to 20000 (Short-time rated 0.01%).

【#13049】 SP049 FFC Acceleration rate feed forward gain

When a relative error in the synchronous control is too large, set this parameter to the axis that is delaying.

The standard setting is "0". The standard setting in the SHG control is "50".

Adjust relative errors in acceleration/deceleration by increasing the value by 50.

---Setting range---

0 to 999 (%)

【#13050】 SP050 TOF Torque offset

Set the imbalance torque.

---Setting range---

-100 to 100 (Short-time rated %)

【#13051】 SP051 DFBT Dual feed back control time constant

Set the control time constant in dual feed back.
 When the function is valid, the standard setting is "100". When "0" is set, the value is 1 ms.
 When the time constant is increased, the operation will get closer to the semi-closed control and the limit of the position loop gain will be raised.
 However, this cannot be used when the spindle slip occurs in machine configuration such as V-belt drive.

Related parameters: SP017/bit1, SP052

---Setting range---
 0 to 9999 (ms)

【#13052】 SP052 DFBN Dual feedback control non-sensitive band

Set the non-sensitive band in the dual feedback control.
 Normally set to "0".

Related parameters: SP017/bit1, SP051

---Setting range---
 0 to 9999 (1/1000°)

【#13053】 SP053 ODS Excessive error detection width (non-interpolation mode)

Set the excessive error detection width in non-interpolation mode.
 Standard setting value: $ODS = \text{Maximum motor speed [r/min]} \times 6/PGV/2$

When set to "0", the excessive error detection will not be performed.

---Setting range---
 0 to 32767 (°)

【#13054】 SP054 ORE Overrun detection width in closed loop control

Set the overrun detection width in the full-closed loop control.
 When the gap between the motor side detector and the machine side detector exceeds the set value, it is judged as an overrun and "Alarm 43" is detected.
 When "-1" is set, if the differential velocity between the motor side detector and the machine side detector exceeds the 30% of the maximum motor speed, it will be judged as overrun and "Alarm 43" will be detected.
 When "0" is set, overrun will be detected with 2°.
 In the full-closed loop control, normally set this parameter to "360". During V-belt drive, set to "-1".

---Setting range---
 -1 to 32767 (°)

【#13055】 SP055 EMGx Max. gate off delay time after emergency stop

Set the time required to forcibly execute READY OFF after the emergency stop is input.
 Normally set to "20000".
 When "0" is set, READY OFF is forcibly executed with "7000ms".
 When the set time is shorter than the time to decelerate and stop, the spindle will stop with the dynamic brake after the set time is out.

Related parameters: SP056

---Setting range---
 0 to 29900 (ms)

【#13056】 SP056 EMGt Deceleration time constant at emergency stop

Set the time constant used for the deceleration control at emergency stop. Set the time required to stop from the maximum motor speed (TSP).
 When "0" is set, the deceleration control is executed with "7000ms".

Related parameters: SP055

---Setting range---
 0 to 29900 (ms)

【#13057(PR)】 SP057 GRA1 Spindle side gear ratio 1

Set the number of gear teeth on the spindle side when "the gear selection command (control input 4/bit6, 5) " is set to "00".

---Setting range---
1 to 32767

【#13058(PR)】 SP058 GRA2 Spindle side gear ratio 2

Set the number of gear teeth on the spindle side when "the gear selection command (control input 4/bit6, 5) " is set to "01".

---Setting range---
1 to 32767

【#13059(PR)】 SP059 GRA3 Spindle side gear ratio 3

Set the number of gear teeth on the spindle side when "the gear selection command (control input 4/bit6, 5) " is set to "10".

---Setting range---
1 to 32767

【#13060(PR)】 SP060 GRA4 Spindle side gear ratio 4

Set the number of gear teeth on the spindle side when "the gear selection command (control input 4/bit6, 5) " is set to "11".

---Setting range---
1 to 32767

【#13061(PR)】 SP061 GRB1 Motor side gear ratio 1

Set the number of gear teeth on the motor side when "the gear selection command (control input 4/bit6, 5) " is set to "00".

---Setting range---
1 to 32767

【#13062(PR)】 SP062 GRB2 Motor side gear ratio 2

Set the number of gear teeth on the motor side when "the gear selection command (control input 4/bit6, 5) " is set to "01".

---Setting range---
1 to 32767

【#13063(PR)】 SP063 GRB3 Motor side gear ratio 3

Set the number of gear teeth on the motor side when "the gear selection command (control input 4/bit6, 5) " is set to "10".

---Setting range---
1 to 32767

【#13064(PR)】 SP064 GRB4 Motor side gear ratio 4

Set the number of gear teeth on the motor side when "the gear selection command (control input 4/bit6, 5) " is set to "11".

---Setting range---
1 to 32767

【#13065】 SP065 TLM1 Torque limit 1

Set the torque limit value when "the torque limit (control input 1/bitA, 9, 8) " is set to "001".

---Setting range---
0 to 999 (Short-time rated %)

【#13066】 SP066 TLM2 Torque limit 2

Set the torque limit value when "the torque limit (control input 1/bitA, 9, 8)" is set to "010".

---Setting range---

0 to 999 (Short-time rated %)

【#13067】 SP067 TLM3 Torque limit 3

Set the torque limit value when "the torque limit (control input 1/bitA, 9, 8)" is set to "011".

---Setting range---

0 to 999 (Short-time rated %)

【#13068】 SP068 TLM4 Torque limit 4

Set the torque limit value when "the torque limit (control input 1/bitA, 9, 8)" is set to "100".

---Setting range---

0 to 999 (Short-time rated %)

【#13069】 SP069 PCMP Phase alignment completion width

Set the single-rotation position alignment completion width for phase alignment and changing from non-interpolation to spindle synchronization mode during rotation.
Set the rotation error that is required to the machine.
When the setting value decreases, the rotation error will decrease, but the cycle time (settling time) will get longer. The standard setting is "875".

---Setting range---

0 to 32767 (1°/1000)

【#13070】 SP070 KDDT Phase alignment deceleration rate scale

Set the scale for SP016 (DDT) to change the deceleration rate only during rotation command (command F Δ T ≠ 0).
When the setting value increases, the single-rotation position alignment will be completed faster, but the impact to the machine will also increase. When not using, set to "0".

---Setting range---

0 to 255 (1/16-fold)

【#13071】 SP071 DIQM Variable current limit during deceleration, lower limit value

Set this parameter to adjust the deceleration time by changing the current limit value during deceleration depending on the motor speed.
As shown below, set the lower limit rate of the current limit in SP071 (DIQM), and use with SP072 (DIQN).
When DIQM is set to 100%, the standard current limit value in deceleration (TMLR) is applied.

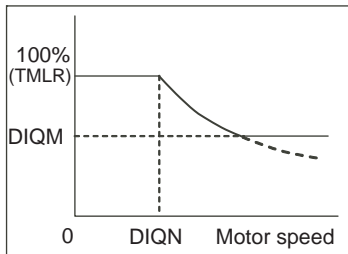

---Setting range---

0 to 999 (%)

【#13072】 SP072 DIQN Variable current limit during deceleration, break point speed

Set this parameter to adjust the deceleration time by changing the current limit value during deceleration depending on the motor speed.

As shown below, set the lower limit rate of the current limit in SP071 (DIQM), and use with SP072 (DIQN).

When DIQM is set to 100%, the standard current limit value in deceleration (TMLR) is applied.

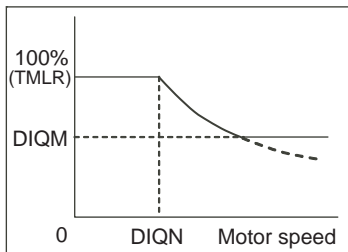
**---Setting range---**

1 to 32767 (r/min)

【#13073】 SP073 VGVN Variable speed gain target value

If noise is bothersome during high speed rotation, it may be reduced by lowering the speed loop gain at high speed.

Set this value to ensure the adequate response by suppressing noise and vibration at low speeds and increasing the speed loop gain at high speeds for a high-speed spindle of machining center, etc. As shown below, set the speed loop gain rate for the overspeed detection speed in SP073 (VGVN), and use with SP074 (VGVS).

When not using, set to "0".

The overspeed detection speed (VLMT) is 115% of the maximum motor speed (TSP).

This function can be used when either Speed loop gain set 1 or Speed loop gain set 2 is selected.

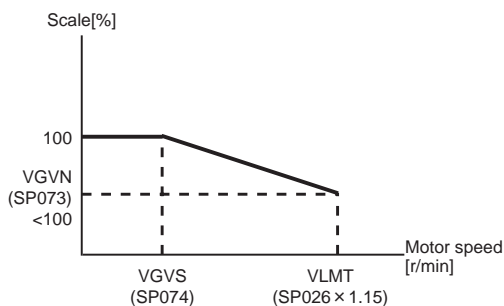

When lowering the speed loop gain at high speed

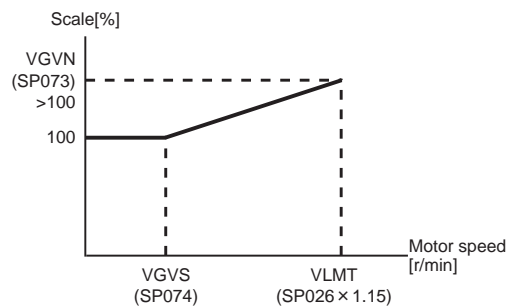

When increasing the speed loop gain at high speed

---Setting range---

0 to 999 (%)

【#13074】 SP074 VGVS Variable speed gain change start speed

If noise is bothersome during high speed rotation, it may be reduced by lowering the speed loop gain at high speed.

Set this value to ensure the adequate response by suppressing noise and vibration at low speeds and increasing the speed loop gain at high speeds for a high-speed spindle of machining center, etc. As shown below, set the speed loop gain rate for the overspeed detection speed in SP073 (VGVN), and use with SP074 (VGVS).

When not using, set to "0".

The overspeed detection speed (VLMT) is 115% of the maximum motor speed (TSP).

This function can be used when either Speed loop gain set 1 or Speed loop gain set 2 is selected.

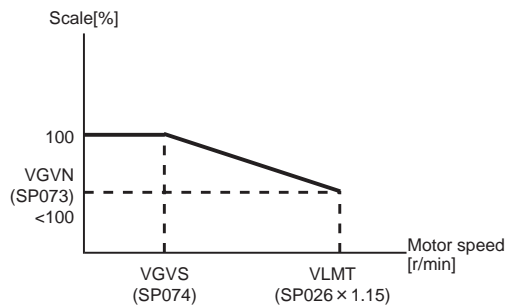

When lowering the speed loop gain at high speed

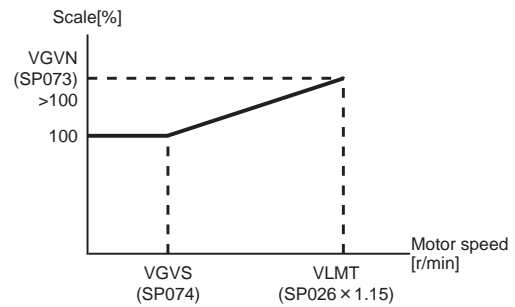

When increasing the speed loop gain at high speed

---Setting range---
0 to 32767 (r/min)

【#13075】 SP075 DWSH Slip compensation scale during regeneration high-speed coil

Set the slip frequency scale during deceleration. Normally, set to "0". (For machine tool builder adjustment)

---Setting range---
0 to 255 (1/16-fold)

【#13076】 SP076 DWSL Slip compensation scale during regeneration low-speed coil

Set the slip frequency scale at deceleration when using the low-speed coil. Normally, set to "0". (For machine tool builder adjustment)

---Setting range---
0 to 255 (1/16-fold)

【#13077】 SP077 IQA Q axis current lead compensation

Set the current loop gain. To use the coil switch function, set the current loop gain for when the high-speed coil is selected. The setting value is determined by the motor's electrical characteristics so that the value is fixed to each motor used. Set the value given in the spindle parameter list. (For machine tool builder adjustment)

---Setting range---
1 to 20480

【#13078】 SP078 IDA D axis current lead compensation

Set the current loop gain. To use the coil switch function, set the current loop gain for when the high-speed coil is selected. The setting value is determined by the motor's electrical characteristics so that the value is fixed to each motor used. Set the value given in the spindle parameter list. (For machine tool builder adjustment)

---Setting range---
1 to 20480

【#13079】 SP079 IQG Q axis current gain

Set the current loop gain.

To use the coil switch function, set the current loop gain for when the high-speed coil is selected. The setting value is determined by the motor's electrical characteristics so that the value is fixed to each motor used.

Set the value given in the spindle parameter list. (For machine tool builder adjustment)

---Setting range---

1 to 8192

【#13080】 SP080 IDG D axis current gain

Set the current loop gain.

To use the coil switch function, set the current loop gain for when the high-speed coil is selected. The setting value is determined by the motor's electrical characteristics so that the value is fixed to each motor used.

Set the value given in the spindle parameter list. (For machine tool builder adjustment)

---Setting range---

1 to 8192

【#13081】 SP081 IQAL Q axis current lead compensation low-speed coil

When using coil switch function, set the current loop gain for when the low-speed coil is selected.

The setting value is determined by the motor's electrical characteristics so that the value is fixed to each motor used.

Set the value given in the spindle parameter list. (For machine tool builder adjustment)

---Setting range---

1 to 20480

【#13082】 SP082 IDAL D axis current lead compensation low-speed coil

When using coil switch function, set the current loop gain for when the low-speed coil is selected.

The setting value is determined by the motor's electrical characteristics so that the value is fixed to each motor used.

Set the value given in the spindle parameter list. (For machine tool builder adjustment)

---Setting range---

1 to 20480

【#13083】 SP083 IQGL Q axis current gain low-speed coil

When using coil switch function, set the current loop gain for when the low-speed coil is selected.

The setting value is determined by the motor's electrical characteristics so that the value is fixed to each motor used.

Set the value given in the spindle parameter list. (For machine tool builder adjustment)

---Setting range---

1 to 8192

【#13084】 SP084 IDGL D axis current gain low-speed coil

When using coil switch function, set the current loop gain for when the low-speed coil is selected.

The setting value is determined by the motor's electrical characteristics so that the value is fixed to each motor used.

Set the value given in the spindle parameter list. (For machine tool builder adjustment)

---Setting range---

1 to 8192

【#13085】 SP085

Not used. Set to "0".

【#13086】 SP086

Not used. Set to "0".

【#13087】 SP087 FHz4 Notch filter frequency 4

Set the vibration frequency to suppress when machine vibration occurs.
 (Enabled at 50 or more.)
 When not using, set to "0".

Related parameters: SP034/bitB-9

---Setting range---
 0 to 2250 (Hz)

【#13088】 SP088 FHz5 Notch filter frequency 5

Set the vibration frequency to suppress when machine vibration occurs.
 (Enabled at 50 or more.)
 When not using, set to "0".

Related parameters: SP034/bitF-D

---Setting range---
 0 to 2250 (Hz)

【#13089】 SP089 TMKQ Spindle output stabilizing gain Q axis

Set the magnification of the torque current stabilizing gain. (For machine tool builder adjustment)
 When set to "0", the torque current stabilization is disabled.
 When not using, set to "0".

---Setting range---
 0 to 32767

【#13090】 SP090 TMKD Spindle output stabilizing gain D axis

Set the magnification of the excitation current stabilizing gain. (For machine tool builder adjustment)
 When set to "0", the excitation current stabilization is disabled.
 When not using, set to "0".

---Setting range---
 0 to 32767

【#13091】 SP091

Not used. Set to "0".

【#13092】 SP092

Not used. Set to "0".

【#13093】 SP093

Not used. Set to "0".

【#13094】 SP094 MPV Magnetic pole error detection speed

In the magnetic pole position detection function, the command motor speed and motor speed during the position command stop are monitored.

Set the command motor speed level and motor speed level during the position command stop in "r/min" unit.

When the command motor speed level is set to "0", the magnetic pole position error is detected at 10r/min.

Set to "10" as a standard setting when the magnetic pole position error detection function is enabled. This detects the magnetic pole position error when the motor speed is "100r/min".

Ten-thousands digit, Thousands digit ----- Command motor speed level (10r/min)
 Hundreds digit, Tens digit, Ones digit ----- Motor speed level (10r/min)

---Setting range---
 0 to 31999

【#13095】 SP095 VIAX Lead compensation scale during high-response acceleration/ deceleration

Set the magnification against delay/lead compensation (SP006) of the high-response acceleration/ deceleration (valid when SP226/ bitD is set to "1").
Normally, set to "0". Set this parameter to suppress overshooting when the speed is reached.

---Setting range---

0 to 10000 (0.01%)

【#13096】 SP096 SDW Speed slowdown allowable width

When the spindle slows down due to multiple cutting, set the processable speed as percentage against the NC command speed.
When "0" is set, the magnification is the same as when "85" is set. When set to "-1", the allowable width will be disabled.

---Setting range---

-1,0 to 100(%)

【#13097】 SP097 RNG1ex Extension sub side detector resolution

When setting the machine side detector resolution in pulse (p) unit, set the number of pulses to four bite data of SP097 (high-order) and SP019 (low-order) in pulse (p) unit.

When SP097=0, the setting unit of SP019 is (kp).
Refer to SP019 for details.

Related parameters: SP019, SP020, SP098

---Setting range---

-1 to 32767

【#13098】 SP098 RNG2ex Extension main side detector resolution

When setting the motor side detector resolution in pulse (p) unit, set the number of pulses to four bite data of SP098 (high-order) and SP020 (low-order) in pulse (p) unit.

When SP098=0, the setting unit of SP020 is (kp).
Refer to SP020 for details.

Related parameters: SP019, SP020, SP097

---Setting range---

-1 to 32767

【#13099】 SP099

Not used. Set to "0".

【#13100】 SP100

Not used. Set to "0".

【#13101】 SP101 TMA1 OMR-FF movement averaging filter time constant 1

Set the movement averaging filter time constant in OMR-FF control.
The standard setting is "88".
Set to "0" when not using OMR-FF control.

---Setting range---

0 to 711 (0.01ms)

【#13102】 SP102 TMA2 OMR-FF movement averaging filter time constant 2

Set the movement averaging filter time constant in OMR-FF control.
 The standard setting is "88".
 Set to "0" when not using OMR-FF control.

---Setting range---
 0 to 711 (0.01ms)

【#13103】 SP103

Not used. Set to "0".

【#13104】 SP104 FFR0 OMR-FF inner rounding compensation gain for G0

Set the inner rounding compensation amount (drive side feed forward gain) in OMR-FF control.
 When a shape tracking error is too large in OMR-FF control, adjust it by setting this parameter.
 The higher the setting value is, the less the shape tracking error will be, however, overshooting during acceleration/deceleration will increase.
 Lower the value when vibration occurs during the G0 acceleration/deceleration.
 The standard setting is "10000".
 Set to "0" when not using OMR-FF control.

---Setting range---
 0 to 20000 (0.01%)

【#13105】 SP105 FFR1 OMR-FF inner rounding compensation gain for G1

Set the inner rounding compensation amount (drive side feed forward gain) in OMR-FF control.
 When a shape tracking error is too large in OMR-FF control, adjust it by setting this parameter.
 The higher the setting value is, the less the shape tracking error will be, however, overshooting during acceleration/deceleration will increase.
 Lower the value when vibration occurs during the G1 acceleration/deceleration.
 The standard setting is "10000".
 Set to "0" when not using OMR-FF control.

---Setting range---
 0 to 20000 (0.01%)

【#13106】 SP106 PGM OMR-FF scale model gain

Set the scale model gain (position response) in OMR-FF control.
 Set the same value as SP002(PGN).
 Increase the setting value to perform a high-speed machining such as a fine arc or to improve the path error.
 Lower the value when vibration occurs during acceleration/deceleration.
 Set to "0" when not using OMR-FF control.

---Setting range---
 0 to 300 (rad/s)

【#13107】 SP107

Not used. Set to "0".

【#13108】 SP108

Not used. Set to "0".

【#13109】 SP109

Not used. Set to "0".

【#13110】 SP110

Not used. Set to "0".

【#13111】 SP111

Not used. Set to "0".

【#13112】 SP112 IFF OMR-FF current feed forward gain

Set the current feed forward rate in OMR-FF control.
The standard setting is "10000".
Setting value of 0 is equal to "10000(100%)" setting.
Set to "0" when not using OMR-FF control.

---Setting range---

0 to 32767 (0.01%)

【#13113】 SP113 OPLP Current command value for open loop

Set the current command value for when the open loop control is enabled.
When "0" is set, the state will be the same as when "50" is set.
When not using, set to "0".
The open loop control is enabled when "SP018/bit1" is set to "1".

---Setting range---

0 to 999 (Short-time rated %)

【#13114】 SP114 MKT Coil changeover gate cutoff timer

Set the time required to cut off the gate when turning OFF/ON the coil switch contactor.
The value should be longer than the coil switch contactor's OFF/ON time.
The standard setting is "150".

---Setting range---

0 to 3500 (ms)

【#13115】 SP115 MKT2 Coil changeover current limit timer

Set the time required to limit the current immediately after the coil switch contactor ON/OFF is completed and the gate is turned ON.
The standard setting is "250".

---Setting range---

0 to 3500 (ms)

【#13116】 SP116 MKIL Coil changeover current limit value

Set the time required to limit the current immediately after the coil switch contactor ON/OFF is completed and the gate is turned ON.
The standard setting is "120".

---Setting range---

0 to 999 (Short-time rated %)

【#13117】 SP117 SETM Excessive speed deviation timer

Set the time to detect the speed excessive error alarm.
Set the time required to the machine.
The standard setting is "12".

---Setting range---

0 to 60 (s)

【#13118(PR)】 SP118 MSFT Magnetic pole shift amount

Set the magnetic pole shift amount of IPM spindle motor.
During DC excitation of the initial setup: Set the same value displayed in the "AFLT gain" on the NC monitor screen in SP225/bit4=1.
When not using, set to "0".

---Setting range---

-18000 to 18000 (electrical angle 0.01°)

【#13119】 SP119

Not used. Set to "0".

【#13120】 SP120

Not used. Set to "0".

【#13121】 SP121 MP Kpp Magnetic pole detection position loop gain

Set the position loop gain in the magnetic polar detection loop.
This is used in the initial magnetic polar detection when the IPM spindle motor is turned ON.
Set to "0" when using an IM spindle motor.

---Setting range---
0 to 32767

【#13122】 SP122 MP Kvp Magnetic pole detection speed loop gain

Set the speed loop gain in the magnetic polar detection loop.
This is used in the initial magnetic polar detection when the IPM spindle motor is turned ON.
Set to "0" when using an IM spindle motor.

---Setting range---
0 to 32767

【#13123】 SP123 MP Kvi Magnetic pole detection speed loop lead compensation

Set the speed loop lead compensation in the magnetic detection loop.
This is used in the initial magnetic polar detection when the IPM spindle motor is turned ON.
Set to "0" when using an IM spindle motor.

---Setting range---
0 to 32767

【#13124】 SP124 ILMTsp Magnetic pole detection current limit value

Set the current limit value for the magnetic polar detection loop.
This is used in the initial magnetic polar detection when the IPM spindle motor is turned ON.
Set to "0" when using an IM spindle motor.

---Setting range---
0 to 999 (Short-time rated %)

【#13125】 SP125 DA1NO D/A output ch1 data No. / Initial DC excitation level

Input the desired data number to D/A output channel.
When using the 2-axis drive unit, set "-1" to the axis that the data will not be output.

When the DC excitation is running:
Use in the DC excitation function.
DC excitation: Set the initial excitation level when SP225/bit4=1.
When "0" is set, the state will be the same as when "20" is set.

---Setting range---
-32768 to 32767

【#13126】 SP126 DA2NO D/A output ch2 data No. / Final DC excitation level

Input the desired data number to D/A output channel.
When using the 2-axis drive unit, set "-1" to the axis that the data will not be output.

When the DC excitation is running:
Use in the DC excitation function.
DC excitation: Set the final excitation level when SP225/bit4=1.
When "0" is set, the state will be the same as when "50" is set.

---Setting range---
-32768 to 32767

【#13127】 SP127 DA1MPY D/A output ch1 output scale / Initial DC excitation time

Set the output scale in increments of 1/100.
When "0" is set, the scale is the same as when "100" is set.

When the DC excitation is running:
Use in the DC excitation function.
DC excitation: Set the initial excitation time when SP225/bit4=1.
When "0" is set, the state will be the same as when "10000" is set.

---Setting range---
-32768 to 32767 (1/100-fold)

【#13128】 SP128 DA2MPY D/A output ch2 output scale

Set the output scale in increments of 1/100.
When "0" is set, the scale is the same as when "100" is set.

---Setting range---
-32768 to 32767 (1/100-fold)

【#13129(PR)】 SP129

Set the unique constants for the spindle motor. (High-speed coil)
The setting value is determined by the motor's mechanical and electrical characteristics and specifications, so normally set the value given in the spindle parameter list.

【#13130(PR)】 SP130

Set the unique constants for the spindle motor. (High-speed coil)
The setting value is determined by the motor's mechanical and electrical characteristics and specifications, so normally set the value given in the spindle parameter list.

【#13131(PR)】 SP131

Set the unique constants for the spindle motor. (High-speed coil)
The setting value is determined by the motor's mechanical and electrical characteristics and specifications, so normally set the value given in the spindle parameter list.

【#13132(PR)】 SP132

Set the unique constants for the spindle motor. (High-speed coil)
The setting value is determined by the motor's mechanical and electrical characteristics and specifications, so normally set the value given in the spindle parameter list.

【#13133(PR)】 SP133

Set the unique constants for the spindle motor. (High-speed coil)
The setting value is determined by the motor's mechanical and electrical characteristics and specifications, so normally set the value given in the spindle parameter list.

【#13134(PR)】 SP134

Set the unique constants for the spindle motor. (High-speed coil)
The setting value is determined by the motor's mechanical and electrical characteristics and specifications, so normally set the value given in the spindle parameter list.

【#13135(PR)】 SP135

Set the unique constants for the spindle motor. (High-speed coil)
The setting value is determined by the motor's mechanical and electrical characteristics and specifications, so normally set the value given in the spindle parameter list.

【#13136(PR)】 SP136

Set the unique constants for the spindle motor. (High-speed coil)
The setting value is determined by the motor's mechanical and electrical characteristics and specifications, so normally set the value given in the spindle parameter list.

【#13137(PR)】 SP137

Set the unique constants for the spindle motor. (High-speed coil)
 The setting value is determined by the motor's mechanical and electrical characteristics and specifications, so normally set the value given in the spindle parameter list.

【#13138(PR)】 SP138

Set the unique constants for the spindle motor. (High-speed coil)
 The setting value is determined by the motor's mechanical and electrical characteristics and specifications, so normally set the value given in the spindle parameter list.

【#13139(PR)】 SP139

Set the unique constants for the spindle motor. (High-speed coil)
 The setting value is determined by the motor's mechanical and electrical characteristics and specifications, so normally set the value given in the spindle parameter list.

【#13140(PR)】 SP140

Set the unique constants for the spindle motor. (High-speed coil)
 The setting value is determined by the motor's mechanical and electrical characteristics and specifications, so normally set the value given in the spindle parameter list.

【#13141(PR)】 SP141

Set the unique constants for the spindle motor. (High-speed coil)
 The setting value is determined by the motor's mechanical and electrical characteristics and specifications, so normally set the value given in the spindle parameter list.

【#13142(PR)】 SP142

Set the unique constants for the spindle motor. (High-speed coil)
 The setting value is determined by the motor's mechanical and electrical characteristics and specifications, so normally set the value given in the spindle parameter list.
 For IPM spindle motor
 This parameter is used in initial magnetic pole detection of IPM spindle motor.
 (1) Pulse application time: Set it in [μ s] unit.(0 < application time < 350)
 (2) Pulse application coil: To select a low-speed coil, add 1000 to the pulse application time.
 (3) Polarity of estimated magnetic pole: When it is set to the reverse polarity, add "-" to the total of (1) and (2).
 E.g.: When performing 333 μ s pulse-applied magnetic pole estimation in a low-speed coil and selecting the reverse polarity for the estimated polarity

$$SP142 = -(333+1000) = -1333$$

【#13143(PR)】 SP143

Set the unique constants for the spindle motor. (High-speed coil)
 The setting value is determined by the motor's mechanical and electrical characteristics and specifications, so normally set the value given in the spindle parameter list.

【#13144(PR)】 SP144

Set the unique constants for the spindle motor. (High-speed coil)
 The setting value is determined by the motor's mechanical and electrical characteristics and specifications, so normally set the value given in the spindle parameter list.

【#13145(PR)】 SP145

Set the unique constants for the spindle motor. (High-speed coil)
 The setting value is determined by the motor's mechanical and electrical characteristics and specifications, so normally set the value given in the spindle parameter list.

【#13146(PR)】 SP146

Set the unique constants for the spindle motor. (High-speed coil)
 The setting value is determined by the motor's mechanical and electrical characteristics and specifications, so normally set the value given in the spindle parameter list.

【#13147(PR)】 SP147

Set the unique constants for the spindle motor. (High-speed coil)
The setting value is determined by the motor's mechanical and electrical characteristics and specifications, so normally set the value given in the spindle parameter list.

【#13148(PR)】 SP148

Set the unique constants for the spindle motor. (High-speed coil)
The setting value is determined by the motor's mechanical and electrical characteristics and specifications, so normally set the value given in the spindle parameter list.

【#13149(PR)】 SP149

Set the unique constants for the spindle motor. (High-speed coil)
The setting value is determined by the motor's mechanical and electrical characteristics and specifications, so normally set the value given in the spindle parameter list.

【#13150(PR)】 SP150

Set the unique constants for the spindle motor. (High-speed coil)
The setting value is determined by the motor's mechanical and electrical characteristics and specifications, so normally set the value given in the spindle parameter list.

【#13151(PR)】 SP151

Set the unique constants for the spindle motor. (High-speed coil)
The setting value is determined by the motor's mechanical and electrical characteristics and specifications, so normally set the value given in the spindle parameter list.

【#13152(PR)】 SP152

Set the unique constants for the spindle motor. (High-speed coil)
The setting value is determined by the motor's mechanical and electrical characteristics and specifications, so normally set the value given in the spindle parameter list.

【#13153(PR)】 SP153

Set the unique constants for the spindle motor. (High-speed coil)
The setting value is determined by the motor's mechanical and electrical characteristics and specifications, so normally set the value given in the spindle parameter list.

【#13154(PR)】 SP154

Set the unique constants for the spindle motor. (High-speed coil)
The setting value is determined by the motor's mechanical and electrical characteristics and specifications, so normally set the value given in the spindle parameter list.

【#13155(PR)】 SP155

Set the unique constants for the spindle motor. (High-speed coil)
The setting value is determined by the motor's mechanical and electrical characteristics and specifications, so normally set the value given in the spindle parameter list.

【#13156(PR)】 SP156

Set the unique constants for the spindle motor. (High-speed coil)
The setting value is determined by the motor's mechanical and electrical characteristics and specifications, so normally set the value given in the spindle parameter list.

【#13157(PR)】 SP157

Set the unique constants for the spindle motor. (High-speed coil)
The setting value is determined by the motor's mechanical and electrical characteristics and specifications, so normally set the value given in the spindle parameter list.

【#13158(PR)】 SP158

Set the unique constants for the spindle motor. (High-speed coil)
The setting value is determined by the motor's mechanical and electrical characteristics and specifications, so normally set the value given in the spindle parameter list.

【#13159(PR)】 SP159

Set the unique constants for the spindle motor. (High-speed coil)
The setting value is determined by the motor's mechanical and electrical characteristics and specifications, so normally set the value given in the spindle parameter list.

【#13160(PR)】 SP160

Set the unique constants for the spindle motor. (High-speed coil)
The setting value is determined by the motor's mechanical and electrical characteristics and specifications, so normally set the value given in the spindle parameter list.

【#13161(PR)】 SP161

Set the unique constants for the spindle motor. (Low-speed coil)
The setting value is determined by the motor's mechanical and electrical characteristics and specifications, so normally set the value given in the spindle parameter list.

【#13162(PR)】 SP162

Set the unique constants for the spindle motor. (Low-speed coil)
The setting value is determined by the motor's mechanical and electrical characteristics and specifications, so normally set the value given in the spindle parameter list.

【#13163(PR)】 SP163

Set the unique constants for the spindle motor. (Low-speed coil)
The setting value is determined by the motor's mechanical and electrical characteristics and specifications, so normally set the value given in the spindle parameter list.

【#13164(PR)】 SP164

Set the unique constants for the spindle motor. (Low-speed coil)
The setting value is determined by the motor's mechanical and electrical characteristics and specifications, so normally set the value given in the spindle parameter list.

【#13165(PR)】 SP165

Set the unique constants for the spindle motor. (Low-speed coil)
The setting value is determined by the motor's mechanical and electrical characteristics and specifications, so normally set the value given in the spindle parameter list.

【#13166(PR)】 SP166

Set the unique constants for the spindle motor. (Low-speed coil)
The setting value is determined by the motor's mechanical and electrical characteristics and specifications, so normally set the value given in the spindle parameter list.

【#13167(PR)】 SP167

Set the unique constants for the spindle motor. (Low-speed coil)
The setting value is determined by the motor's mechanical and electrical characteristics and specifications, so normally set the value given in the spindle parameter list.

【#13168(PR)】 SP168

Set the unique constants for the spindle motor. (Low-speed coil)
The setting value is determined by the motor's mechanical and electrical characteristics and specifications, so normally set the value given in the spindle parameter list.

【#13169(PR)】 SP169

Set the unique constants for the spindle motor. (Low-speed coil)
The setting value is determined by the motor's mechanical and electrical characteristics and specifications, so normally set the value given in the spindle parameter list.

【#13170(PR)】 SP170

Set the unique constants for the spindle motor. (Low-speed coil)
The setting value is determined by the motor's mechanical and electrical characteristics and specifications, so normally set the value given in the spindle parameter list.

【#13171(PR)】 SP171

Set the unique constants for the spindle motor. (Low-speed coil)
The setting value is determined by the motor's mechanical and electrical characteristics and specifications, so normally set the value given in the spindle parameter list.

【#13172(PR)】 SP172

Set the unique constants for the spindle motor. (Low-speed coil)
The setting value is determined by the motor's mechanical and electrical characteristics and specifications, so normally set the value given in the spindle parameter list.

【#13173(PR)】 SP173

Set the unique constants for the spindle motor. (Low-speed coil)
The setting value is determined by the motor's mechanical and electrical characteristics and specifications, so normally set the value given in the spindle parameter list.

【#13174(PR)】 SP174

Set the unique constants for the spindle motor. (Low-speed coil)
The setting value is determined by the motor's mechanical and electrical characteristics and specifications, so normally set the value given in the spindle parameter list.

【#13175(PR)】 SP175

Set the unique constants for the spindle motor. (Low-speed coil)
The setting value is determined by the motor's mechanical and electrical characteristics and specifications, so normally set the value given in the spindle parameter list.

【#13176(PR)】 SP176

Set the unique constants for the spindle motor. (Low-speed coil)
The setting value is determined by the motor's mechanical and electrical characteristics and specifications, so normally set the value given in the spindle parameter list.

【#13177(PR)】 SP177

Set the unique constants for the spindle motor. (Low-speed coil)
The setting value is determined by the motor's mechanical and electrical characteristics and specifications, so normally set the value given in the spindle parameter list.

【#13178(PR)】 SP178

Set the unique constants for the spindle motor. (Low-speed coil)
The setting value is determined by the motor's mechanical and electrical characteristics and specifications, so normally set the value given in the spindle parameter list.

【#13179(PR)】 SP179

Set the unique constants for the spindle motor. (Low-speed coil)
The setting value is determined by the motor's mechanical and electrical characteristics and specifications, so normally set the value given in the spindle parameter list.

【#13180(PR)】 SP180

Set the unique constants for the spindle motor. (Low-speed coil)
The setting value is determined by the motor's mechanical and electrical characteristics and specifications, so normally set the value given in the spindle parameter list.

【#13181(PR)】 SP181

Set the unique constants for the spindle motor. (Low-speed coil)
The setting value is determined by the motor's mechanical and electrical characteristics and specifications, so normally set the value given in the spindle parameter list.

【#13182(PR)】 SP182

Set the unique constants for the spindle motor. (Low-speed coil)
The setting value is determined by the motor's mechanical and electrical characteristics and specifications, so normally set the value given in the spindle parameter list.

【#13183(PR)】 SP183

Set the unique constants for the spindle motor. (Low-speed coil)
 The setting value is determined by the motor's mechanical and electrical characteristics and specifications, so normally set the value given in the spindle parameter list.

【#13184(PR)】 SP184

Set the unique constants for the spindle motor. (Low-speed coil)
 The setting value is determined by the motor's mechanical and electrical characteristics and specifications, so normally set the value given in the spindle parameter list.

【#13185(PR)】 SP185

Set the unique constants for the spindle motor. (Low-speed coil)
 The setting value is determined by the motor's mechanical and electrical characteristics and specifications, so normally set the value given in the spindle parameter list.

【#13186(PR)】 SP186

Set the unique constants for the spindle motor. (Low-speed coil)
 The setting value is determined by the motor's mechanical and electrical characteristics and specifications, so normally set the value given in the spindle parameter list.

【#13187(PR)】 SP187

Set the unique constants for the spindle motor. (Low-speed coil)
 The setting value is determined by the motor's mechanical and electrical characteristics and specifications, so normally set the value given in the spindle parameter list.

【#13188(PR)】 SP188

Set the unique constants for the spindle motor. (Low-speed coil)
 The setting value is determined by the motor's mechanical and electrical characteristics and specifications, so normally set the value given in the spindle parameter list.

【#13189(PR)】 SP189

Set the unique constants for the spindle motor. (Low-speed coil)
 The setting value is determined by the motor's mechanical and electrical characteristics and specifications, so normally set the value given in the spindle parameter list.

【#13190(PR)】 SP190

Set the unique constants for the spindle motor. (Low-speed coil)
 The setting value is determined by the motor's mechanical and electrical characteristics and specifications, so normally set the value given in the spindle parameter list.

【#13191(PR)】 SP191

Set the unique constants for the spindle motor. (Low-speed coil)
 The setting value is determined by the motor's mechanical and electrical characteristics and specifications, so normally set the value given in the spindle parameter list.

【#13192(PR)】 SP192

Set the unique constants for the spindle motor. (Low-speed coil)
 The setting value is determined by the motor's mechanical and electrical characteristics and specifications, so normally set the value given in the spindle parameter list.

【#13193】 SP193 LMR Change magnification for load meter standard output (High-speed coil)

Set the standard output to be displayed as 100% in load meter using the short-time rated output ratio.
 To display the continuous rated output as 100%, set as follows.
 Continuous rated output/Short-time rated output × 100
 When "0" is set, normal display will be applied.
 It is not available for MDS-DJ-SP Series.

---Setting range---
 0 to 100 (%)

【#13194】 SP194 LMN Base speed for load meter standard output (High-speed coil)

Set the base speed of the standard output to be displayed as 100% in load meter.
When "0" is set, the base speed of the short-time rated output will be applied.
It is not available for MDS-DJ-SP Series.

---Setting range---
0 to 32767 (r/min)

【#13195】 SP195 LMRL Change magnification for load meter standard output (Low-speed coil)

Set the standard output to be displayed as 100% in load meter using the short-time rated output ratio.
To display the continuous rated output as 100%, set as follows.
Continuous rated output/Short-time rated output × 100
When "0" is set, normal display will be applied.
It is not available for MDS-DJ-SP Series.

---Setting range---
0 to 100 (%)

【#13196】 SP196 LMNL Base speed for load meter standard output (Low-speed coil)

Set the base speed of the standard output to be displayed as 100% in load meter.
When "0" is set, the base speed of the short-time rated output will be applied.
It is not available for MDS-DJ-SP Series.

---Setting range---
0 to 32767 (r/min)

【#13197】 SP197

Not used. Set to "0".

【#13198】 SP198

Not used. Set to "0".

【#13199】 SP199

Not used. Set to "0".

【#13200】 SP200

Not used. Set to "0".

【#13201】 SP201

Not used. Set to "0".

【#13202】 SP202

Not used. Set to "0".

【#13203】 SP203

Not used. Set to "0".

【#13204】 SP204

Not used. Set to "0".

【#13205】 SP205

Not used. Set to "0".

【#13206】 SP206

Not used. Set to "0".

【#13207】 SP207

Not used. Set to "0".

【#13208】 SP208

Not used. Set to "0".

【#13209】 SP209

Not used. Set to "0".

【#13210】 SP210

Not used. Set to "0".

【#13211】 SP211

Not used. Set to "0".

【#13212】 SP212

Not used. Set to "0".

【#13213】 SP213

Not used. Set to "0".

【#13214】 SP214

Not used. Set to "0".

【#13215】 SP215

Not used. Set to "0".

【#13216】 SP216

Not used. Set to "0".

【#13217】 SP217

Not used. Set to "0".

【#13218】 SP218

Not used. Set to "0".

【#13219】 SP219

Not used. Set to "0".

【#13220】 SP220

Not used. Set to "0".

【#13221】 SP221

Not used. Set to "0".

【#13222】 SP222

Not used. Set to "0".

【#13223】 SP223

Not used. Set to "0".

【#13224】 SP224

Not used. Set to "0".

【#13225】 SP225 SFNC5 Spindle function 5

Select the spindle functions.
Functions are allocated to each bit.
Set this in hexadecimal format.

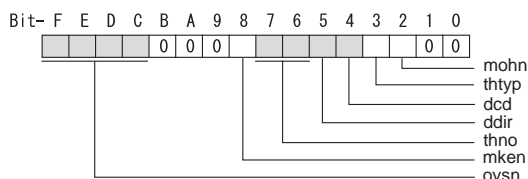
**bit F-C : ovsn Overshooting compensation type 3 non-sensitive band**

Set the non-sensitive band of the overshooting compensation type 3 in increments of $2^\circ/1000$.
In the feed forward control, set the non-sensitive band for the model position droop and ignore the model overshooting. Set to " $2^\circ/1000$ " as a standard.

bit B-9 :

Not used. Set to "0".

bit 8 : mken Coil switch allowance in deceleration control

This enables a coil changeover while decelerating after an emergency stop for a spindle motor with coil changeover specification. A coil changeover may enable an excessive load inertia to stop within the maximum delay time.
0: Normal (Disable) 1: Enable

bit 7-6 : thno

Select the thermistor characteristics.
When SP225/bit3=0 (N type) is selected
bit7,6=
00: For Mitsubishi spindle motor
01: Setting prohibited
10: Setting prohibited
11: Setting prohibited
When SP225/bit3=1 (P type) is selected
bit7,6=
00: KTY84-130 (Manufactured by Philips)
01: Setting prohibited
10: Setting prohibited
11: Setting prohibited

bit 5 : ddir Proximity switch signal enable edge

0: Falling edge 1: Rising edge

bit 4 : dcd DC excitation mode

0: Normal 1: Start

bit 3 : thtyp

Select the thermistor type.
0: Type N thermistor (Mitsubishi standard) 1: Type P thermistor

bit 2 : mohn Thermistor temperature detection

0: Normal 1: Disable (Except for TS5690/5691)

bit 1-0 :

Not used. Set to "0".

【#13226】 SP226 SFNC6 Spindle function 6

Select the spindle functions.
 Functions are allocated to each bit.
 Set this in hexadecimal format.

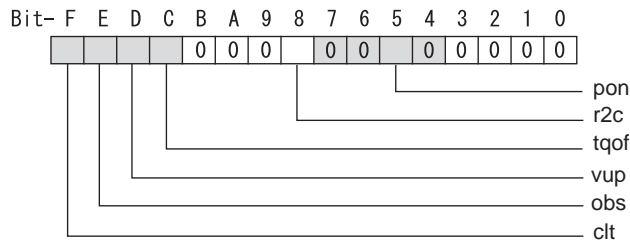

bit F : clt Spindle monitor load inertia ratio

0: Normal 1: Display

bit E : obs Disturbance observer

0: Normal 1: Enable

bit D : vup High response acceleration / deceleration

This suppresses a temporal delay which occurs when the target speed is attained from acceleration and when the spindle stops from deceleration.

0: Normal acceleration/deceleration 1: High response acceleration/deceleration Enable

bit C : tqof Spindle output stabilization during acceleration

0: Normal 1: Disable

bit B-9 :

Not used. Set to "0".

bit 8 : r2c Temperature compensation adjustment indicator

0: Normal 1: Display

bit 7-6 :

Not used. Set to "0".

bit 5 : pon IPM spindle pulse application magnetic pole estimation

0: Normal 1: Enable

bit 4-0 :

Not used. Set to "0".

【#13227】 SP227 SFNC7 Spindle function 7

Select the spindle functions.
Functions are allocated to each bit.
Set this in hexadecimal format.

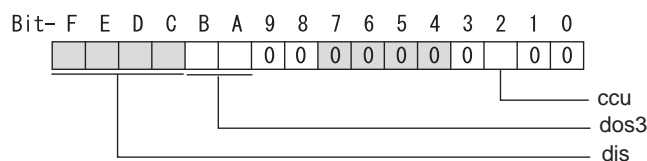
**bit F-C : dis Digital signal input selection**

0: No signal
1: SLS (Safely Limited Speed) function door state signal
4: Proximity switch signal detection
Other settings: setting prohibited

bit B-A : dos3 Digital signal output 3 selection (MDS-DJ-SP)

bitB,A=
00: Disable
01: Setting prohibited
10: Contactor control signal output
11: Setting prohibited

bit 9-3 :

Not used. Set to "0".

bit 2 : ccu Lost motion/overshoot compensation compensation amount setting unit

0: Short-time rated % 1: Short-time rated 0.01%

bit 1-0 :

Not used. Set to "0".

【#13228】 SP228 SFNC8 Spindle function 8

Not used. Set to "0000".

【#13229】 SP229 SFNC9 Spindle function 9

Select the spindle functions.
 Functions are allocated to each bit.
 Set this in hexadecimal format.

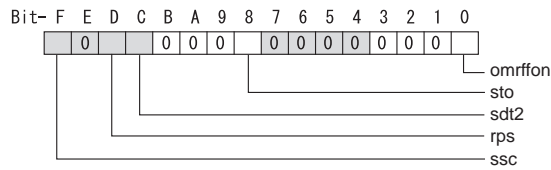

bit F : ssc SLS (Safely Limited Speed) function

0: Disable 1: Enable

bit E :

Not used. Set to "0".

bit D : rps Safely limited speed setting unit

0: Normal 1: 100°/min

bit C : sdt2 Specified speed output digital signal 2 output

0: Normal 1: Enable

bit B-9 :

Not used. Set to "0".

bit 8 : sto Dedicated wiring STO function

Set this parameter to use dedicated wiring STO function.
 0: Dedicated wiring STO function unused 1: Dedicated wiring STO function used

bit 7-1 :

Not used. Set to "0".

bit 0 : omrffon OMR-FF control enabled

0: Disable 1: Enable

【#13230】 SP230 SFNC10 Spindle function 10

Select the spindle functions.
Functions are allocated to each bit.
Set this in hexadecimal format.

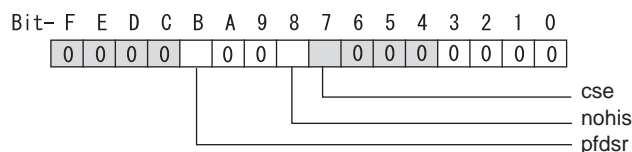
**bit F-C :**

Not used. Set to "0".

bit B : pfdsr

Set the spindle stop operation at a power failure when the deceleration and stop function at power failure is enabled.

Normal (Coast to a stop at power failure) : 0

Deceleration and stop at power failure : 8

bit A-9 :

Not used. Set to "0".

bit 8 : nohis History of communication error alarm between NC and DRV(34,36,38,39)

0: Enable 1: Disable

bit 7 : cse Spindle C axis command speed monitoring function

0: Normal setting (function disabled) 1: Function enabled

bit 6-0 :

Not used. Set to "0".

【#13231】 SP231

Not used. Set to "0000".

【#13232】 SP232

Not used. Set to "0000".

【#13233】 SP233 IVC Voltage non-sensitive band compensation

When 100% is set, the voltage equivalent to the logical non-energized time will be compensated.
When "0" is set, 100% compensation will be performed.
Adjust in increments of 10% from the default value 100%.
If the value is too large, vibration or vibration noise may be generated.

---Setting range---

0 to 255 (%)

【#13234】 SP234

Not used. Set to "0".

【#13235(PR)】 SP235 R2H Temperature compensation gain

Set the magnification in converting the thermistor temperature to the control compensation amount.
When "0" is set, the temperature compensation function is disabled.
When not using, or when using an IPM spindle motor, set to "0".

---Setting range---

0 to 400 (%)

【#13236(PR) SP236 WIH Temperature compensation time constant

Set the delay time constant from the thermistor temperature to the control compensation amount.
When "0" is set, the delay time constant is disabled.
When not using, or when using an IPM spindle motor, set to "0".

---Setting range---
0 to 150 (min)

【#13237(PR) SP237 TCF Torque command filter

Set the filter for the torque command.
When not using, set to "0".
The standard value is "500" when using the motor side detector TS5690 or TS5691.

---Setting range---
0 to 4500 (Hz)

【#13238] SP238 SSCFEED Safely limited speed

Set the safely limited speed at the spindle end for the SLS (Safely Limited Speed) function.
When not using, set to "0".

---Setting range---
0 to 18000 (°/min)
However, when SP229/bitD is set to "1", the setting range is from -32768 to 32767 (100°/min).

【#13239] SP239 SSCRPM Safely limited motor speed

Set the motor's safely limited speed for the SLS (Safely Limited Speed) function.
Set a value to hold the following relationship.

$SP239 = (SP238 / 360) \times (SP057 / SP061)$
Only when the product is 0, set to "1".

When not using, set to "0".

Related parameters: SP229/bitD, SP229/bitF, SP238

---Setting range---
0 to 32767 (r/min)

【#13240(PR) SP240

Not used. Set to "0".

【#13241(PR) SP241

This is automatically set by the NC system.

【#13242(PR) SP242

This is automatically set by the NC system.

【#13243(PR) SP243

This is automatically set by the NC system.

【#13244(PR) SP244

This is automatically set by the NC system.

【#13245(PR) SP245

This is automatically set by the NC system.

【#13246(PR) SP246

This is automatically set by the NC system.

【#13247(PR)】 SP247

This is automatically set by the NC system.

【#13248(PR)】 SP248

This is automatically set by the NC system.

【#13249(PR)】 SP249

This is automatically set by the NC system.

【#13250(PR)】 SP250

This is automatically set by the NC system.

【#13251(PR)】 SP251

This is automatically set by the NC system.

【#13252(PR)】 SP252

This is automatically set by the NC system.

【#13253(PR)】 SP253

This is automatically set by the NC system.

【#13254(PR)】 SP254

This is automatically set by the NC system.

【#13255(PR)】 SP255

This is automatically set by the NC system.

【#13256(PR)】 SP256

This is automatically set by the NC system.

【#13501】 vfths11 Variable speed thread multi-step acceleration/deceleration changeover speed 1(gear 00)

Set the spindle speed for executing the first-step acceleration/deceleration time constant changeover with gear00.

---Setting range---
0 to 99999 (r/min)

【#13502】 vfths12 Variable speed thread multi-step acceleration/deceleration changeover speed 1(gear 01)

Set the spindle speed for executing the first-step acceleration/deceleration time constant changeover with gear01.

---Setting range---
0 to 99999 (r/min)

【#13503】 vfths13 Variable speed thread multi-step acceleration/deceleration changeover speed 1(gear 10)

Set the spindle speed for executing the first-step acceleration/deceleration time constant changeover with gear10.

---Setting range---
0 to 99999 (r/min)

【#13504】 vfths14 Variable speed thread multi-step acceleration/deceleration changeover speed 1(gear 11)

Set the spindle speed for executing the first-step acceleration/deceleration time constant changeover with gear11.

---Setting range---
0 to 99999 (r/min)

【#13505】 vftht11 Variable speed thread multi-step acceleration/deceleration changeover time constant 1 (gear 00)

Set the time constant for reaching the variable speed thread multi-step acceleration/deceleration changeover speed 1 with gear 00.

---Setting range---
0 to 30000 (10ms)

【#13506】 vftht12 Variable speed thread multi-step acceleration/deceleration changeover time constant 1 (gear 01)

Set the time constant for reaching the variable speed thread multi-step acceleration/deceleration changeover speed 1 with gear 01.

---Setting range---
0 to 30000 (10ms)

【#13507】 vftht13 Variable speed thread multi-step acceleration/deceleration changeover time constant 1 (gear 10)

Set the time constant for reaching the variable speed thread multi-step acceleration/deceleration changeover speed 1 with gear 10.

---Setting range---
0 to 30000 (10ms)

【#13508】 vftht14 Variable speed thread multi-step acceleration/deceleration changeover time constant 1 (gear 11)

Set the time constant for reaching the variable speed thread multi-step acceleration/deceleration changeover speed 1 with gear 11.

---Setting range---
0 to 30000 (10ms)

【#13509】 vfths21 Variable speed thread multi-step acceleration/deceleration changeover speed 2(gear 00)

Set the spindle speed for executing the second-step acceleration/deceleration time constant changeover with gear00.

---Setting range---
0 to 99999 (r/min)

【#13510】 vfths22 Variable speed thread multi-step acceleration/deceleration changeover speed 2(gear 01)

Set the spindle speed for executing the second-step acceleration/deceleration time constant changeover with gear01.

---Setting range---
0 to 99999 (r/min)

【#13511】 vfths23 Variable speed thread multi-step acceleration/deceleration changeover speed 2(gear 10)

Set the spindle speed for executing the second-step acceleration/deceleration time constant changeover with gear10.

---Setting range---
0 to 99999 (r/min)

【#13512】 vfths24 Variable speed thread multi-step acceleration/deceleration changeover speed 2(gear 11)

Set the spindle speed for executing the second-step acceleration/deceleration time constant changeover with gear11.

---Setting range---
0 to 99999 (r/min)

【#13513】 vftht21 Variable speed thread multi-step acceleration/deceleration changeover time constant 2(gear 00)

Set the time constant for reaching the variable speed thread multi-step acceleration/deceleration changeover speed 2 with gear 00.

---Setting range---
0 to 30000 (10ms)

【#13514】 vftht22 Variable speed thread multi-step acceleration/deceleration changeover time constant 2(gear 01)

Set the time constant for reaching the variable speed thread multi-step acceleration/deceleration changeover speed 2 with gear 01.

---Setting range---
0 to 30000 (10ms)

【#13515】 vftht23 Variable speed thread multi-step acceleration/deceleration changeover time constant 2(gear 10)

Set the time constant for reaching the variable speed thread multi-step acceleration/deceleration changeover speed 2 with gear 10.

---Setting range---
0 to 30000 (10ms)

【#13516】 vftht24 Variable speed thread multi-step acceleration/deceleration changeover time constant 2(gear 11)

Set the time constant for reaching the variable speed thread multi-step acceleration/deceleration changeover speed 2 with gear 11.

---Setting range---
0 to 30000 (10ms)

【#13517】 vftht31 Variable speed thread multi-step acceleration/deceleration changeover time constant 3(gear 00)

Set the time constant for reaching the limit rotation speed with gear 00.

---Setting range---
0 to 30000 (10ms)

【#13518】 vftht32 Variable speed thread multi-step acceleration/deceleration changeover time constant 3(gear 01)

Set the time constant for reaching the limit rotation speed with gear 01.

---Setting range---
0 to 30000 (10ms)

【#13519】 vftht33 Variable speed thread multi-step acceleration/deceleration changeover time constant 3(gear 10)

Set the time constant for reaching the limit rotation speed with gear 10.

---Setting range---
0 to 30000 (10ms)

【#13520】 vftht34 Variable speed thread multi-step acceleration/deceleration changeover time constant 3(gear 11)

Set the time constant for reaching the limit rotation speed with gear 11.

---Setting range---
0 to 30000 (10ms)

【#13570】 SpStdLv Standard parameter judge level

Set the inertia ratio to judge standard parameters for optimum acceleration/deceleration selection (for spindle).

---Setting range---
0 to 32767 (%)

【#13571】 EstRdyS Estimation preparation: Operation speed

Set the speed when confirming the operation with the inertia estimation parameter.

---Setting range---
0 to 99999 (r/min)

【#13572】 EstRotT Estimation operation: Rotation holding time

Set the spindle rotation holding time after the spindle rotation speed has been reached in inertia estimation.

---Setting range---
0 to 32767 (ms)

【#13573】 EstStopT Estimation operation: Stopping time

Set the spindle rotation stopping time after the spindle rotation speed has been reached in inertia estimation.

---Setting range---
0 to 32767 (ms)

【#13574】 Est-st1 Estimation operation: Time constant 1 for spindle rotation

Set the time constant for spindle rotation (corresponding to #3101 sp_t1) in inertia estimation.

---Setting range---
0 to 30000 (ms)

【#13575】 Est-st2 Estimation operation: Time constant 2 for spindle rotation

Set the time constant for spindle rotation (corresponding to #3102 sp_t2) in inertia estimation.

---Setting range---
0 to 30000 (ms)

【#13576】 Est-st3 Estimation operation: Time constant 3 for spindle rotation

Set the time constant for spindle rotation (corresponding to #3103 sp_t3) in inertia estimation.

---Setting range---
0 to 30000 (ms)

【#13577】 Est-st4 Estimation operation: Time constant 4 for spindle rotation

Set the time constant for spindle rotation (corresponding to #3104 sp_t4) in inertia estimation.

---Setting range---
0 to 30000 (ms)

【#13578】 Est-PGV Estimation operation: Position loop gain non-interpolation mode

Set the position loop gain for non-interpolation mode (corresponding to #13001 SP001) in inertia estimation.

---Setting range---
1 to 200 (1/s)

【#13579】 Est-VGN1 Estimation operation: Speed loop gain 1

Set the speed loop gain 1 (corresponding to #13005 SP005) in inertia estimation.

---Setting range---
1 to 9999

【#13580】 Est-VIA1 Estimation operation: Speed loop lead compensation 1

Set the speed loop lead compensation 1 (corresponding to #13006 SP006) in inertia estimation.

---Setting range---
1 to 9999

【#13581】 Est-VIL1 Estimated operation: Speed loop delay compensation 1

Set the speed loop delay compensation 1 (corresponding to #13007 SP007) in inertia estimation.

---Setting range---
0 to 32767

【#13582】 Est-VGN2 Estimation operation: Speed loop gain 2

Set the speed loop gain 2 (corresponding to #13008 SP008) in inertia estimation.

---Setting range---
1 to 9999

【#13583】 Est-VIA2 Estimation operation: Speed loop lead compensation 2

Set the speed loop lead compensation 2 (corresponding to #13009 SP009) in inertia estimation.

---Setting range---
1 to 9999

【#13584】 Est-VIL2 Estimated operation: Speed loop delay compensation 2

Set the speed loop delay compensation 2 (corresponding to #13010 SP010) in inertia estimation.

---Setting range---
0 to 32767

【#13585】 Est-SFC2 Estimation operation: Spindle function selection 2 (Depth)

Set spindle function selection 2 (depth selection, corresponding to #13034 SP034) in inertia estimation.

---Setting range---
Refer to #13034

【#13586】 Est-FHz1 Estimation operation: Notch filter frequency 1

Set the notch filter frequency 1 (corresponding to #13038 SP038) in inertia estimation.

---Setting range---
0 to 2250 (Hz)

【#13587】 Est-FHz2 Estimation operation: Notch filter frequency 2

Set the notch filter frequency 1 (corresponding to #13046 SP046) in inertia estimation.

---Setting range---
0 to 2250 (Hz)

【#13600】 P1-SPLV Parameter group 1: Judge level

Set the inertial ratio to judge heavy workpiece parameter group 1 in optimum acceleration/ deceleration selection.

---Setting range---
0 to 32767 (%)

【#13601】 P1-st1 Parameter group 1: Time constant 1 for spindle rotation with S command

Set the time constant for spindle rotation with S command (corresponding to #3101 sp_t1) for heavy workpiece parameter group 1 in optimum acceleration/deceleration selection.

---Setting range---
0 to 30000 (ms)

【#13602】 P1-st2 Parameter group 1: Time constant 2 for spindle rotation with S command

Set the time constant for spindle rotation with S command (corresponding to #3102 sp_t2) for heavy workpiece parameter group 1 in optimum acceleration/deceleration selection.

---Setting range---
0 to 30000 (ms)

【#13603】 P1-st3 Parameter group 1: Time constant 3 for spindle rotation with S command

Set the time constant for spindle rotation with S command (corresponding to #3103 sp_t3) for heavy workpiece parameter group 1 in optimum acceleration/deceleration selection.

---Setting range---
0 to 30000 (ms)

【#13604】 P1-st4 Parameter group 1: Time constant 4 for spindle rotation with S command

Set the time constant for spindle rotation with S command (corresponding to #3104 sp_t4) for heavy workpiece parameter group 1 in optimum acceleration/deceleration selection.

---Setting range---
0 to 30000 (ms)

【#13605】 P1-s2t1 Parameter group 1: Time constant 1 in orientation/ position loop reference position return

Set the time constant in orientation/ position loop reference position return (corresponding to #3115 sp2_t1) for heavy workpiece parameter group 1 in optimum acceleration/deceleration selection.

---Setting range---
0 to 30000 (ms)

【#13606】 P1-s2t2 Parameter group 1: Time constant 2 in orientation/ position loop reference position return

Set the time constant in orientation/ position loop reference position return (corresponding to #3116 sp2_t2) for heavy workpiece parameter group 1 in optimum acceleration/deceleration selection.

---Setting range---
0 to 30000 (ms)

【#13607】 P1-s2t3 Parameter group 1: Time constant 3 in orientation/ position loop reference position return

Set the time constant in orientation/ position loop reference position return (corresponding to #3117 sp2_t3) for heavy workpiece parameter group 1 in optimum acceleration/deceleration selection.

---Setting range---
0 to 30000 (ms)

【#13608】 P1-s2t4 Parameter group 1: Time constant 4 in orientation/ position loop reference position return

Set the time constant in orientation/ position loop reference position return (corresponding to #3118 sp2_t4) for heavy workpiece parameter group 1 in optimum acceleration/deceleration selection.

---Setting range---
0 to 30000 (ms)

【#13609】 P1-spt Parameter group 1: Spindle synchronization acceleration/deceleration time constant

Set the spindle synchronization acceleration/deceleration time constant (corresponding to #3049 spt) for heavy workpiece parameter group 1 in optimum acceleration/deceleration selection.

---Setting range---
0 to 9999 (ms)

【#13610】 P1-trtt Parameter group 1: Turret indexing time constant

Set the turret indexing time constant (corresponding to #3124 tret_t) for heavy workpiece parameter group 1 in optimum acceleration/deceleration selection.

---Setting range---
0 to 30000 (ms)

【#13612】 P1-tp1 Parameter group 1: Tap time constant

Set the tap time constant (corresponding to #3017 stapt1) for heavy workpiece parameter group 1 in optimum acceleration/deceleration selection.

---Setting range---
1 to 5000 (ms)

【#13613】 P1-tp2 Parameter group 1: Tap time constant

Set the tap time constant (corresponding to #3018 stapt2) for heavy workpiece parameter group 1 in optimum acceleration/deceleration selection.

---Setting range---
1 to 5000 (ms)

【#13614】 P1-tp3 Parameter group 1: Tap time constant

Set the tap time constant (corresponding to #3019 stapt3) for heavy workpiece parameter group 1 in optimum acceleration/deceleration selection.

---Setting range---
1 to 5000 (ms)

【#13615】 P1-tp4 Parameter group 1: Tap time constant

Set the tap time constant (corresponding to #3020 stapt4) for heavy workpiece parameter group 1 in optimum acceleration/deceleration selection.

---Setting range---
1 to 5000 (ms)

【#13616】 P1-tp21 Parameter group 1: Synchronous tap switching time constant 2

Set the synchronous tap switching time constant 2 (corresponding to #3041 tapt21) for heavy workpiece parameter group 1 in optimum acceleration/deceleration selection.

---Setting range---
1 to 5000 (ms)

【#13617】 P1-tp22 Parameter group 1: Synchronous tap switching time constant 2

Set the synchronous tap switching time constant 2 (corresponding to #3042 tapt22) for heavy workpiece parameter group 1 in optimum acceleration/deceleration selection.

---Setting range---
1 to 5000 (ms)

【#13618】 P1-tp23 Parameter group 1: Synchronous tap switching time constant 2

Set the synchronous tap switching time constant 2 (corresponding to #3043 tapt23) for heavy workpiece parameter group 1 in optimum acceleration/deceleration selection.

---Setting range---
1 to 5000 (ms)

【#13619】 P1-tp24 Parameter group 1: Synchronous tap switching time constant 2

Set the synchronous tap switching time constant 2 (corresponding to #3044 tapt24) for heavy workpiece parameter group 1 in optimum acceleration/deceleration selection.

---Setting range---
1 to 5000 (ms)

【#13620】 P1-tp31 Parameter group 1: Synchronous tap switching time constant 3

Set the synchronous tap switching time constant 3 (corresponding to #3045 tapt31) for heavy workpiece parameter group 1 in optimum acceleration/deceleration selection.

---Setting range---
1 to 5000 (ms)

【#13621】 P1-tp32 Parameter group 1: Synchronous tap switching time constant 3

Set the synchronous tap switching time constant 3 (corresponding to #3046 tapt32) for heavy workpiece parameter group 1 in optimum acceleration/deceleration selection.

---Setting range---
1 to 5000 (ms)

【#13622】 P1-tp33 Parameter group 1: Synchronous tap switching time constant 3

Set the synchronous tap switching time constant 3 (corresponding to #3047 tapt33) for heavy workpiece parameter group 1 in optimum acceleration/deceleration selection.

---Setting range---
1 to 5000 (ms)

【#13623】 P1-tp34 Parameter group 1: Synchronous tap switching time constant 3

Set the synchronous tap switching time constant 3 (corresponding to #3048 tapt34) for heavy workpiece parameter group 1 in optimum acceleration/deceleration selection.

---Setting range---
1 to 5000 (ms)

【#13624】 P1-PGV Parameter group 1: Position loop gain Non-interpolation mode

Set the position loop gain for non-interpolation mode (corresponding to #13001 SP001) for heavy workpiece parameter group 1 in optimum acceleration/deceleration selection.

---Setting range---
1 to 200 (1/s)

【#13625】 P1-PGN Parameter group 1: Position loop gain interpolation mode

Set the position loop gain for interpolation mode (corresponding to #13002 SP002) for heavy workpiece parameter group 1 in optimum acceleration/deceleration selection.

---Setting range---
1 to 200 (1/s)

【#13626】 P1-PGS Parameter group 1: Position loop gain spindle synchronization

Set the position loop gain for spindle synchronization (corresponding to #13003 SP003) for heavy workpiece parameter group 1 in optimum acceleration/deceleration selection.

---Setting range---
1 to 200 (1/s)

【#13627】 P1-VGN1 Parameter group 1: Speed loop gain 1

Set the speed loop gain 1 (corresponding to #13005 SP005) for heavy workpiece parameter group 1 in optimum acceleration/deceleration selection.

---Setting range---
1 to 9999

【#13628】 P1-VIA1 Parameter group 1: Speed loop lead compensation 1

Set the speed loop lead compensation 1 (corresponding to #13006 SP006) for heavy workpiece parameter group 1 in optimum acceleration/deceleration selection.

---Setting range---
1 to 9999

【#13629】 P1-VIL1 Parameter group 1: Speed loop delay compensation 1

Set the speed loop delay compensation 1 (corresponding to #13007 SP007) for heavy workpiece parameter group 1 in optimum acceleration/deceleration selection.

---Setting range---
0 to 32767

【#13630】 P1-VGN2 Parameter group 1: Speed loop gain 2

Set the speed loop gain 2 (corresponding to #13008 SP00) for heavy workpiece parameter group 1 in optimum acceleration/deceleration selection.

---Setting range---
1 to 9999

【#13631】 P1-VIA2 Parameter group 1: Speed loop lead compensation 2

Set the speed loop lead compensation 2 (corresponding to #13009 SP009) for heavy workpiece parameter group 1 in optimum acceleration/deceleration selection.

---Setting range---
1 to 9999

【#13632】 P1-VIL2 Parameter group 1: Speed loop delay compensation 2

Set the speed loop delay compensation 2 (corresponding to #13010 SP010) for heavy workpiece parameter group 1 in optimum acceleration/deceleration selection.

---Setting range---
0 to 32767

【#13633】 P1-SFC2 Parameter group 1: Spindle function selection 2 (Depth)

Set the spindle function selection 2 (depth selection, corresponding to #13034 SP034) for heavy workpiece parameter group 1 in optimum acceleration/deceleration selection.

---Setting range---
Refer to #13034 SP034

【#13634】 P1-FHz1 Parameter group 1: Notch filter frequency 1

Set the notch filter frequency 1 (corresponding to #13038 SP038) for heavy workpiece parameter group 1 in optimum acceleration/deceleration selection.

---Setting range---
0 to 2250 (Hz)

【#13635】 P1-FHz2 Parameter group 1: Notch filter frequency 2

Set the notch filter frequency 2 (corresponding to #13046 SP046) for heavy workpiece parameter group 1 in optimum acceleration/deceleration selection.

---Setting range---
0 to 2250 (Hz)

【#13680】 P2-SPLV Parameter group 2: Judge level

Set the inertial ratio to judge heavy workpiece Parameter group 2 in optimum acceleration/deceleration selection.

---Setting range---
0 to 32767 (%)

【#13681】 P2-st1 Parameter group 2: Time constant 1 for spindle rotation with S command

Set the time constant for spindle rotation with S command (corresponding to #3101 sp_t1) for heavy workpiece Parameter group 2 in optimum acceleration/deceleration selection.

---Setting range---
0 to 30000 (ms)

【#13682】 P2-st2 Parameter group 2: Time constant 2 for spindle rotation with S command

Set the time constant for spindle rotation with S command (corresponding to #3102 sp_t2) for heavy workpiece Parameter group 2 in optimum acceleration/deceleration selection.

---Setting range---
0 to 30000 (ms)

【#13683】 P2-st3 Parameter group 2: Time constant 3 for spindle rotation with S command

Set the time constant for spindle rotation with S command (corresponding to #3103 sp_t3) for heavy workpiece Parameter group 2 in optimum acceleration/deceleration selection.

---Setting range---
0 to 30000 (ms)

【#13684】 P2-st4 Parameter group 2: Time constant 4 for spindle rotation with S command

Set the time constant for spindle rotation with S command (corresponding to #3104 sp_t4) for heavy workpiece Parameter group 2 in optimum acceleration/deceleration selection.

---Setting range---
0 to 30000 (ms)

【#13685】 P2-s2t1 Parameter group 2: Time constant 1 in orientation/ position loop reference position return

Set the time constant in orientation/ position loop reference position return (corresponding to #3115 sp2_t1) for heavy workpiece Parameter group 2 in optimum acceleration/deceleration selection.

---Setting range---
0 to 30000 (ms)

【#13686】 P2-s2t2 Parameter group 2: Time constant 2 in orientation/ position loop reference position return

Set the time constant in orientation/ position loop reference position return (corresponding to #3116 sp2_t2) for heavy workpiece Parameter group 2 in optimum acceleration/deceleration selection.

---Setting range---
0 to 30000 (ms)

【#13687】 P2-s2t3 Parameter group 2: Time constant 3 in orientation/ position loop reference position return

Set the time constant in orientation/ position loop reference position return (corresponding to #3117 sp2_t3) for heavy workpiece Parameter group 2 in optimum acceleration/deceleration selection.

---Setting range---
0 to 30000 (ms)

【#13688】 P2-s2t4 Parameter group 2: Time constant 4 in orientation/ position loop reference position return

Set the time constant in orientation/ position loop reference position return (corresponding to #3118 sp2_t4) for heavy workpiece Parameter group 2 in optimum acceleration/deceleration selection.

---Setting range---
0 to 30000 (ms)

【#13689】 P2-spt Parameter group 2: Spindle synchronization acceleration/deceleration time constant

Set the spindle synchronization acceleration/deceleration time constant (corresponding to #3049 spt) for heavy workpiece Parameter group 2 in optimum acceleration/deceleration selection.

---Setting range---
0 to 9999 (ms)

【#13690】 P2-trtt Parameter group 2: Turret indexing time constant

Set the turret indexing time constant (corresponding to #3124 tret_t) for heavy workpiece Parameter group 2 in optimum acceleration/deceleration selection.

---Setting range---
0 to 30000 (ms)

【#13692】 P2-tp1 Parameter group 2: Tap time constant

Set the tap time constant (corresponding to #3017 stapt1) for heavy workpiece Parameter group 2 in optimum acceleration/deceleration selection.

---Setting range---
1 to 5000 (ms)

【#13693】 P2-tp2 Parameter group 2: Tap time constant

Set the tap time constant (corresponding to #3018 stapt2) for heavy workpiece Parameter group 2 in optimum acceleration/deceleration selection.

---Setting range---
1 to 5000 (ms)

【#13694】 P2-tp3 Parameter group 2: Tap time constant

Set the tap time constant (corresponding to #3019 stapt3) for heavy workpiece Parameter group 2 in optimum acceleration/deceleration selection.

---Setting range---
1 to 5000 (ms)

【#13695】 P2-tp4 Parameter group 2: Tap time constant

Set the tap time constant (corresponding to #3020 stapt4) for heavy workpiece Parameter group 2 in optimum acceleration/deceleration selection.

---Setting range---
1 to 5000 (ms)

【#13696】 P2-tp21 Parameter group 2: Synchronous tap switching time constant 2

Set the synchronous tap switching time constant 2 (corresponding to #3041 tapt21) for heavy workpiece Parameter group 2 in optimum acceleration/deceleration selection.

---Setting range---
1 to 5000 (ms)

【#13697】 P2-tp22 Parameter group 2: Synchronous tap switching time constant 2

Set the synchronous tap switching time constant 2 (corresponding to #3042 tapt22) for heavy workpiece Parameter group 2 in optimum acceleration/deceleration selection.

---Setting range---
1 to 5000 (ms)

【#13698】 P2-tp23 Parameter group 2: Synchronous tap switching time constant 2

Set the synchronous tap switching time constant 2 (corresponding to #3043 tapt23) for heavy workpiece Parameter group 2 in optimum acceleration/deceleration selection.

---Setting range---
1 to 5000 (ms)

【#13699】 P2-tp24 Parameter group 2: Synchronous tap switching time constant 2

Set the synchronous tap switching time constant 2 (corresponding to #3044 tapt24) for heavy workpiece Parameter group 2 in optimum acceleration/deceleration selection.

---Setting range---
1 to 5000 (ms)

【#13700】 P2-tp31 Parameter group 2: Synchronous tap switching time constant 3

Set the synchronous tap switching time constant 3 (corresponding to #3045 tapt31) for heavy workpiece Parameter group 2 in optimum acceleration/deceleration selection.

---Setting range---
1 to 5000 (ms)

【#13701】 P2-tp32 Parameter group 2: Synchronous tap switching time constant 3

Set the synchronous tap switching time constant 3 (corresponding to #3046 tapt32) for heavy workpiece Parameter group 2 in optimum acceleration/deceleration selection.

---Setting range---
1 to 5000 (ms)

【#13702】 P2-tp33 Parameter group 2: Synchronous tap switching time constant 3

Set the synchronous tap switching time constant 3 (corresponding to #3047 tapt33) for heavy workpiece Parameter group 2 in optimum acceleration/deceleration selection.

---Setting range---
1 to 5000 (ms)

【#13703】 P2-tp34 Parameter group 2: Synchronous tap switching time constant 3

Set the synchronous tap switching time constant 3 (corresponding to #3048 tapt34) for heavy workpiece Parameter group 2 in optimum acceleration/deceleration selection.

---Setting range---
1 to 5000 (ms)

【#13704】 P2-PGV Parameter group 2: Position loop gain Non-interpolation mode

Set the position loop gain for non-interpolation mode (corresponding to #13001 SP001) for heavy workpiece Parameter group 2 in optimum acceleration/deceleration selection.

---Setting range---
1 to 200 (1/s)

【#13705】 P2-PGN Parameter group 2: Position loop gain interpolation mode

Set the position loop gain for interpolation mode (corresponding to #13002 SP002) for heavy workpiece Parameter group 2 in optimum acceleration/deceleration selection.

---Setting range---
1 to 200 (1/s)

【#13706】 P2-PGS Parameter group 2: Position loop gain spindle synchronization

Set the position loop gain for spindle synchronization (corresponding to #13003 SP003) for heavy workpiece Parameter group 2 in optimum acceleration/deceleration selection.

---Setting range---
1 to 200 (1/s)

【#13707】 P2-VGN1 Parameter group 2: Speed loop gain 1

Set the speed loop gain 1 (corresponding to #13005 SP005) for heavy workpiece Parameter group 2 in optimum acceleration/deceleration selection.

---Setting range---
1 to 9999

【#13708】 P2-VIA1 Parameter group 2: Speed loop lead compensation 1

Set the speed loop lead compensation 1 (corresponding to #13006 SP006) for heavy workpiece Parameter group 2 in optimum acceleration/deceleration selection.

---Setting range---
1 to 9999

【#13709】 P2-VIL1 Parameter group 2: Speed loop delay compensation 1

Set the speed loop delay compensation 1 (corresponding to #13007 SP007) for heavy workpiece Parameter group 2 in optimum acceleration/deceleration selection.

---Setting range---
0 to 32767

【#13710】 P2-VGN2 Parameter group 2: Speed loop gain 2

Set the speed loop gain 2 (corresponding to #13008 SP00) for heavy workpiece Parameter group 2 in optimum acceleration/deceleration selection.

---Setting range---
1 to 9999

【#13711】 P2-VIA2 Parameter group 2: Speed loop lead compensation 2

Set the speed loop lead compensation 2 (corresponding to #13009 SP009) for heavy workpiece Parameter group 2 in optimum acceleration/deceleration selection.

---Setting range---
1 to 9999

【#13712】 P2-VIL2 Parameter group 2: Speed loop delay compensation 2

Set the speed loop delay compensation 2 (corresponding to #13010 SP010) for heavy workpiece Parameter group 2 in optimum acceleration/deceleration selection.

---Setting range---
0 to 32767

【#13713】 P2-SFC2 Parameter group 2: Spindle function selection 2 (Depth)

Set the spindle function selection 2 (depth selection, corresponding to #13034 SP034) for heavy workpiece Parameter group 2 in optimum acceleration/deceleration selection.

---Setting range---

Refer to #13034 SP034

【#13714】 P2-FHz1 Parameter group 2: Notch filter frequency 1

Set the notch filter frequency 1 (corresponding to #13038 SP038) for heavy workpiece Parameter group 2 in optimum acceleration/deceleration selection.

---Setting range---

0 to 2250 (Hz)

【#13715】 P2-FHz2 Parameter group 2: Notch filter frequency 2

Set the notch filter frequency 2 (corresponding to #13046 SP046) for heavy workpiece Parameter group 2 in optimum acceleration/deceleration selection.

---Setting range---

0 to 2250 (Hz)

【#13760】 P3-SPLV Parameter group 3: Judge level

Set the inertial ratio to judge heavy workpiece Parameter group 3 in optimum acceleration/deceleration selection.

---Setting range---

0 to 32767 (%)

【#13761】 P3-st1 Parameter group 3: Time constant 1 for spindle rotation with S command

Set the time constant for spindle rotation with S command (corresponding to #3101 sp_t1) for heavy workpiece Parameter group 3 in optimum acceleration/deceleration selection.

---Setting range---

0 to 30000 (ms)

【#13762】 P3-st2 Parameter group 3: Time constant 2 for spindle rotation with S command

Set the time constant for spindle rotation with S command (corresponding to #3102 sp_t2) for heavy workpiece Parameter group 3 in optimum acceleration/deceleration selection.

---Setting range---

0 to 30000 (ms)

【#13763】 P3-st3 Parameter group 3: Time constant 3 for spindle rotation with S command

Set the time constant for spindle rotation with S command (corresponding to #3103 sp_t3) for heavy workpiece Parameter group 3 in optimum acceleration/deceleration selection.

---Setting range---

0 to 30000 (ms)

【#13764】 P3-st4 Parameter group 3: Time constant 4 for spindle rotation with S command

Set the time constant for spindle rotation with S command (corresponding to #3104 sp_t4) for heavy workpiece Parameter group 3 in optimum acceleration/deceleration selection.

---Setting range---

0 to 30000 (ms)

【#13765】 P3-s2t1 Parameter group 3: Time constant 1 in orientation/ position loop reference position return

Set the time constant in orientation/ position loop reference position return (corresponding to #3115 sp2_t1) for heavy workpiece Parameter group 3 in optimum acceleration/deceleration selection.

---Setting range---

0 to 30000 (ms)

【#13766】 P3-s2t2 Parameter group 3: Time constant 2 in orientation/ position loop reference position return

Set the time constant in orientation/ position loop reference position return (corresponding to #3116 sp2_t2) for heavy workpiece Parameter group 3 in optimum acceleration/deceleration selection.

---Setting range---
0 to 30000 (ms)

【#13767】 P3-s2t3 Parameter group 3: Time constant 3 in orientation/ position loop reference position return

Set the time constant in orientation/ position loop reference position return (corresponding to #3117 sp2_t3) for heavy workpiece Parameter group 3 in optimum acceleration/deceleration selection.

---Setting range---
0 to 30000 (ms)

【#13768】 P3-s2t4 Parameter group 3: Time constant 4 in orientation/ position loop reference position return

Set the time constant in orientation/ position loop reference position return (corresponding to #3118 sp2_t4) for heavy workpiece Parameter group 3 in optimum acceleration/deceleration selection.

---Setting range---
0 to 30000 (ms)

【#13769】 P3-spt Parameter group 3: Spindle synchronization acceleration/deceleration time constant

Set the spindle synchronization acceleration/deceleration time constant (corresponding to #3049 spt) for heavy workpiece Parameter group 3 in optimum acceleration/deceleration selection.

---Setting range---
0 to 9999 (ms)

【#13770】 P3-trtt Parameter group 3: Turret indexing time constant

Set the turret indexing time constant (corresponding to #3124 tret_t) for heavy workpiece Parameter group 3 in optimum acceleration/deceleration selection.

---Setting range---
0 to 30000 (ms)

【#13772】 P3-tp1 Parameter group 3: Tap time constant

Set the tap time constant (corresponding to #3017 stapt1) for heavy workpiece Parameter group 3 in optimum acceleration/deceleration selection.

---Setting range---
1 to 5000 (ms)

【#13773】 P3-tp2 Parameter group 3: Tap time constant

Set the tap time constant (corresponding to #3018 stapt2) for heavy workpiece Parameter group 3 in optimum acceleration/deceleration selection.

---Setting range---
1 to 5000 (ms)

【#13774】 P3-tp3 Parameter group 3: Tap time constant

Set the tap time constant (corresponding to #3019 stapt3) for heavy workpiece Parameter group 3 in optimum acceleration/deceleration selection.

---Setting range---
1 to 5000 (ms)

【#13775】 P3-tp4 Parameter group 3: Tap time constant

Set the tap time constant (corresponding to #3020 stapt4) for heavy workpiece Parameter group 3 in optimum acceleration/deceleration selection.

---Setting range---
1 to 5000 (ms)

【#13776】 P3-tp21 Parameter group 3: Synchronous tap switching time constant 2

Set the synchronous tap switching time constant 2 (corresponding to #3041 tapt21) for heavy workpiece Parameter group 3 in optimum acceleration/deceleration selection.

---Setting range---
1 to 5000 (ms)

【#13777】 P3-tp22 Parameter group 3: Synchronous tap switching time constant 2

Set the synchronous tap switching time constant 2 (corresponding to #3042 tapt22) for heavy workpiece Parameter group 3 in optimum acceleration/deceleration selection.

---Setting range---
1 to 5000 (ms)

【#13778】 P3-tp23 Parameter group 3: Synchronous tap switching time constant 2

Set the synchronous tap switching time constant 2 (corresponding to #3043 tapt23) for heavy workpiece Parameter group 3 in optimum acceleration/deceleration selection.

---Setting range---
1 to 5000 (ms)

【#13779】 P3-tp24 Parameter group 3: Synchronous tap switching time constant 2

Set the synchronous tap switching time constant 2 (corresponding to #3044 tapt24) for heavy workpiece Parameter group 3 in optimum acceleration/deceleration selection.

---Setting range---
1 to 5000 (ms)

【#13780】 P3-tp31 Parameter group 3: Synchronous tap switching time constant 3

Set the synchronous tap switching time constant 3 (corresponding to #3045 tapt31) for heavy workpiece Parameter group 3 in optimum acceleration/deceleration selection.

---Setting range---
1 to 5000 (ms)

【#13781】 P3-tp32 Parameter group 3: Synchronous tap switching time constant 3

Set the synchronous tap switching time constant 3 (corresponding to #3046 tapt32) for heavy workpiece Parameter group 3 in optimum acceleration/deceleration selection.

---Setting range---
1 to 5000 (ms)

【#13782】 P3-tp33 Parameter group 3: Synchronous tap switching time constant 3

Set the synchronous tap switching time constant 3 (corresponding to #3047 tapt33) for heavy workpiece Parameter group 3 in optimum acceleration/deceleration selection.

---Setting range---
1 to 5000 (ms)

【#13783】 P3-tp34 Parameter group 3: Synchronous tap switching time constant 3

Set the synchronous tap switching time constant 3 (corresponding to #3048 tapt34) for heavy workpiece Parameter group 3 in optimum acceleration/deceleration selection.

---Setting range---
1 to 5000 (ms)

【#13784】 P3-PGV Parameter group 3: Position loop gain Non-interpolation mode

Set the position loop gain for non-interpolation mode (corresponding to #13001 SP001) for heavy workpiece Parameter group 3 in optimum acceleration/deceleration selection.

---Setting range---
1 to 200 (1/s)

【#13785】 P3-PGN Parameter group 3: Position loop gain interpolation mode

Set the position loop gain for interpolation mode (corresponding to #13002 SP002) for heavy workpiece Parameter group 3 in optimum acceleration/deceleration selection.

---Setting range---
1 to 200 (1/s)

【#13786】 P3-PGS Parameter group 3: Position loop gain spindle synchronization

Set the position loop gain for spindle synchronization (corresponding to #13003 SP003) for heavy workpiece Parameter group 3 in optimum acceleration/deceleration selection.

---Setting range---
1 to 200 (1/s)

【#13787】 P3-VGN1 Parameter group 3: Speed loop gain 1

Set the speed loop gain 1 (corresponding to #13005 SP005) for heavy workpiece Parameter group 3 in optimum acceleration/deceleration selection.

---Setting range---
1 to 9999

【#13788】 P3-VIA1 Parameter group 3: Speed loop lead compensation 1

Set the speed loop lead compensation 1 (corresponding to #13006 SP006) for heavy workpiece Parameter group 3 in optimum acceleration/deceleration selection.

---Setting range---
1 to 9999

【#13789】 P3-VIL1 Parameter group 3: Speed loop delay compensation 1

Set the speed loop delay compensation 1 (corresponding to #13007 SP007) for heavy workpiece Parameter group 3 in optimum acceleration/deceleration selection.

---Setting range---
0 to 32767

【#13790】 P3-VGN2 Parameter group 3: Speed loop gain 2

Set the speed loop gain 2 (corresponding to #13008 SP00) for heavy workpiece Parameter group 3 in optimum acceleration/deceleration selection.

---Setting range---
1 to 9999

【#13791】 P3-VIA2 Parameter group 3: Speed loop lead compensation 2

Set the speed loop lead compensation 2 (corresponding to #13009 SP009) for heavy workpiece Parameter group 3 in optimum acceleration/deceleration selection.

---Setting range---
1 to 9999

【#13792】 P3-VIL2 Parameter group 3: Speed loop delay compensation 2

Set the speed loop delay compensation 2 (corresponding to #13010 SP010) for heavy workpiece Parameter group 3 in optimum acceleration/deceleration selection.

---Setting range---
0 to 32767

【#13793】 P3-SFC2 Parameter group 3: Spindle function selection 2 (Depth)

Set the spindle function selection 2 (depth selection, corresponding to #13034 SP034) for heavy workpiece Parameter group 3 in optimum acceleration/deceleration selection.

---Setting range---

Refer to #13034 SP034

【#13794】 P3-FHz1 Parameter group 3: Notch filter frequency 1

Set the notch filter frequency 1 (corresponding to #13038 SP038) for heavy workpiece Parameter group 3 in optimum acceleration/deceleration selection.

---Setting range---

0 to 2250 (Hz)

【#13795】 P3-FHz2 Parameter group 3: Notch filter frequency 2

Set the notch filter frequency 2 (corresponding to #13046 SP046) for heavy workpiece Parameter group 3 in optimum acceleration/deceleration selection.

---Setting range---

0 to 2250 (Hz)

2.7 Rotary Axis Configuration Parameters

The parameters with "(PR)" requires the CNC to be turned OFF after the settings. Turn the power OFF and ON to enable the parameter settings.

【#7900(PR)】 RCDAX_I Orthogonal coordinate horizontal axis name

Set the name of the horizontal axis in the orthogonal coordinate system.

---Setting range---

A,B,C,U,V,W,X,Y,Z

【#7901(PR)】 RCDAX_J Orthogonal coordinate vertical axis name

Set the name of the vertical axis in the orthogonal coordinate system.

---Setting range---

A,B,C,U,V,W,X,Y,Z

【#7902(PR)】 RCDAX_K Orthogonal coordinate height axis name

Set the name of the height axis in the orthogonal coordinate system.

---Setting range---

A,B,C,U,V,W,X,Y,Z

【#7903】 G92_CRD Origin zero set coordinate selection

Select the coordinate to preset when issuing an origin zero command (G92X_Y_Z_);.

0: Tool center coordinate

1: Holder center coordinate

【#7904】 NO_TIP Tool handle feed function selection

Select whether to enable the tool handle feed.

0: Enable (tool handle feed)

1: Disable (standard)

【#7905】 NO_ABS Selection of tool axis travel amount display at manual ABS switch ON/OFF

Select how to update the display of tool axis travel amount.

0: Update at ABS switch OFF

1: Update at every ON and OFF of ABS switch

【#7906】 PASSTYP Singular point passage type

Select the movement after passing a singular point.

0: Type 1

A/B axis rotation angle will be in the same sign direction as that when the tool center point control started.

1: Type 2

C axis rotation amount on the singular point will be smaller.

【#7907】 CHK_ANG Near singular judgment angle

Set the angle for judging a position near the singular point.

---Setting range---

0.000 to 5.000 (°)

【#7908】 SLCT_PRG_COORD Programming coordinate system selection

Select the coordinate system for the programming coordinate.

0: Table coordinate system (coordinate system that rotates together with workpiece)

1: Workpiece coordinate system

【#7909】 IJK_VEC_MR Posture vector mirror image selection

Select whether to enable the mirror image on the posture vector (IJK) when Type 2 is selected in "#7906 PASSTYP".

0: Disable

1: Enable

【#7910】 SLCT_INT_MODE Interpolation method selection

Select the interpolation method.
 0: Joint interpolation method
 1: Single axis rotation interpolation method

【#7911】 SLCT_STANDARD_POS Rotary axis basic position selection

Select the basic position of the rotary axis.
 0: Workpiece coordinate zero point
 1: The position when the tool center point is commanded.

(Note) Even if the position is changed, it is not changed during tool center point control. It is changed when next tool center point control will be commanded.

【#7913】 MCHN_SPEED_CTRL Machine speed fluctuation suppression

Select whether to suppress the machine speed fluctuation due to rotary axis movement.
 0: Not suppress
 1: Suppress

(Note) This parameter is disabled when SSS control is enabled.

【#7914】 ROT_PREFILT Rotary axis prefilter time constant

Set the time constant for rotary axis prefilter.
 Setting this parameter can smoothen the tool angle change (rotary axis' motion) under tool center point control.
 When set to "0", "Rotary axis prefiltering" will be disabled.

---Setting range---
 0 to 200 (ms)

【#7915】 SLCT_SLOPE_CRD_MOD Rotary axis basic position in inclined surface machining

Set the basic position of rotary axis to establish the feature coordinate system when inclined surface machining is commanded.
 * The position will not change when inclined surface machining is running. It will change when the next inclined surface machining is commanded.
 0: At zero degree
 1: At the start position

【#7920(PR)】 SLCT_T1 Rotary axis selection

Select in which axis direction to rotate the tool rotating type base-side rotary axis.
 If the tool axis is inclined, use the second digit to set the axis direction in which the tool axis is inclined.
 0: Invalid
 1: I axis rotation
 2: J axis rotation
 3: K axis rotation

(Note) 0 to 99 can be set from the screen, but if an invalid value is set, the operation error "M01 0127 Rot axis parameter error" will occur when the power supply is turned ON.

---Setting range---
 0 to 3
 12, 13, 21, 23, 31, 32

【#7921(PR)】 TIANGT1 Inclination angle

Set the inclination angle if the tool-rotation type base-side rotary axis is inclined. Set the angle regarding CCW direction of the inclined plane as plus direction.

---Setting range---
 -359.999 to 359.999 (°)
 (Follow as "#1003 iunit Input setup unit".)

[#7922(PR)] ROTAXT1 Rotary axis name

Set the name of the tool rotating type base-side rotary axis.

Set "0" when the axis has the mechanical axis specifications. (The setting is, however, invalid in the tool center point control, R-Navi function.)

---Setting range---

0, A, B, C, U, V, W, X, Y, Z

 [#7923] DIR_T1 Rotation direction

Select the rotation direction of the tool rotating type base-side rotary axis.

0: CW

1: CCW

 [#7924] COFST1H Horizontal axis rotation center offset

Set the distance in the horizontal axis direction between the rotation centers of the tool-side rotary axis and the base-side rotary axis.

---Setting range---

-99999.999 to 99999.999 (mm)

 [#7925] COFST1V Vertical axis rotation center offset

Set the distance in the vertical axis direction between the rotation centers of the tool-side rotary axis and the base-side rotary axis.

---Setting range---

-99999.999 to 99999.999 (mm)

 [#7926] COFST1T Height axis rotation center offset

Set the distance in the height axis direction between the rotation centers of the tool-side rotary axis and the base-side rotary axis.

---Setting range---

-99999.999 to 99999.999 (mm)

 [#7927] CERR1H Horizontal axis rotation center error compensation amount

Set the error compensation amount in the horizontal axis direction of the tool rotating type base-side rotary axis rotation center.

---Setting range---

-99999.999 to 99999.999 (mm)

 [#7928] CERR1V Vertical axis rotation center error compensation amount

Set the error compensation amount in the vertical axis direction of the tool rotating type base-side rotary axis rotation center.

---Setting range---

-99999.999 to 99999.999 (mm)

 [#7930(PR)] SLCT_T2 Rotary axis selection

Select in which axis direction to rotate the tool rotating type tool-side rotary axis.

If the tool axis is inclined, use the second digit to set the axis direction in which the tool axis is inclined.

0: Invalid

1: I axis rotation

2: J axis rotation

3: K axis rotation

(Note) 0 to 99 can be set from the screen, but if an invalid value is set, the operation error "M01 0127 Rot axis parameter error" will occur when the power supply is turned ON.

---Setting range---

0 to 3

12, 13, 21, 23, 31, 32

【#7931(PR) TIANGT2 Inclination angle

Set the inclination angle if the tool-rotation type tool-side rotary axis is inclined. Set the angle regarding CCW direction of the inclined plane as plus direction.

---Setting range---
 -359.999 to 359.999 (°)
 (Follow as "#1003 iunit Input setup unit".)

【#7932(PR) ROTAXT2 Rotary axis name

Set the name of the tool rotating type tool-side rotary axis.
 Set "0" when the axis has the mechanical axis specifications. (The setting is, however, invalid in the tool center point control, R-Navi function.)

---Setting range---
 0, A, B, C, U, V, W, X, Y, Z

【#7933] DIR_T2 Rotation direction

Set the rotation direction of the tool rotating type tool-side rotary axis.
 0: CW
 1: CCW

【#7934] COFST2H Horizontal axis rotation center offset

Set the distance in the horizontal axis direction between the spindle holder center and the rotation center of the tool-side rotary axis.

---Setting range---
 -99999.999 to 99999.999 (mm)

【#7935] COFST2V Vertical axis rotation center offset

Set the distance in the vertical axis direction between the spindle holder center and the rotation center of the tool-side rotary axis.

---Setting range---
 -99999.999 to 99999.999 (mm)

【#7936] COFST2T Height axis rotation center offset

Set the distance in the height axis direction between the spindle holder center and the rotation center of the tool-side rotary axis.

---Setting range---
 -99999.999 to 99999.999 (mm)

【#7937] CERRT2H Horizontal axis rotation center error compensation amount

Set the error compensation amount in the horizontal axis direction of the tool rotating type tool-side rotary axis rotation center.

---Setting range---
 -99999.999 to 99999.999 (mm)

【#7938] CERRT2V Vertical axis rotation center error compensation amount

Set the error compensation amount in the vertical axis direction of the tool rotating type tool-side rotary axis rotation center.

---Setting range---
 -99999.999 to 99999.999 (mm)

【#7940(PR)】 SLCT_W1 Rotary axis selection

Select in which axis direction to rotate the table rotating type base-side rotary axis.
If the tool axis is inclined, use the second digit to set the axis direction in which the tool axis is inclined.

- 0: Invalid
- 1: I axis rotation
- 2: J axis rotation
- 3: K axis rotation

(Note) 0 to 99 can be set from the screen, but if an invalid value is set, the operation error "M01 0127 Rot axis parameter error" will occur when the power supply is turned ON.

---Setting range---

- 0 to 3
- 12, 13, 21, 23, 31, 32

【#7941(PR)】 TIANGW1 Inclination angle

Set the inclination angle if the table-rotation type base-side rotary axis is inclined. Set the angle regarding CCW direction of the inclined plane as plus direction.

---Setting range---

- 359.999 to 359.999 (°)
- (Follow as "#1003 iunit Input setup unit".)

【#7942(PR)】 ROTAXW1 Rotary axis name

Set the name of the table rotating type base-side rotary axis.

Set "0" when the axis has the mechanical axis specifications. (The setting is, however, invalid in the tool center point control, R-Navi function.)

---Setting range---

- 0, A, B, C, U, V, W, X, Y, Z

【#7943】 DIR_W1 Rotation direction

Set the rotation direction for the table rotating type base-side rotary axis.

- 0: CW
- 1: CCW

【#7944】 COFSW1H Horizontal axis rotation center offset

When all axes are at the machine basic point, set the distance in the horizontal axis direction from the machine basic point to the rotation center of the base-side rotary axis.

---Setting range---

- 99999.999 to 99999.999 (mm)

【#7945】 COFSW1V Vertical axis rotation center offset

When all axes are at the machine basic point, set the distance in the vertical axis direction from the machine basic point to the rotation center of the base-side rotary axis.

---Setting range---

- 99999.999 to 99999.999 (mm)

【#7946】 COFSW1T Height axis rotation center offset

When all axes are at the machine basic point, set the distance in the height axis direction from the machine basic point to the rotation center of the base-side rotary axis.

---Setting range---

- 99999.999 to 99999.999 (mm)

【#7947】 CERRW1H Horizontal axis rotation center error compensation amount

Set the error compensation amount in the horizontal axis direction of the table rotating type base-side rotary axis rotation center.

---Setting range---

- 99999.999 to 99999.999 (mm)

【#7948】 CERRW1V Vertical axis rotation center error compensation amount

Set the error compensation amount in the vertical axis direction of the table rotating type base-side rotary axis rotation center.

---Setting range---
-99999.999 to 99999.999 (mm)

【#7950(PR)】 SLCT_W2 Rotary axis selection

Set in which direction to rotate the table rotating type workpiece-side rotary axis. If the tool axis is inclined, use the second digit to set the axis direction in which the tool axis is inclined.

- 0: Invalid
- 1: I axis rotation
- 2: J axis rotation
- 3: K axis rotation

(Note) 0 to 99 can be set from the screen, but if an invalid value is set, the operation error "M01 0127 Rot axis parameter error" will occur when the power supply is turned ON.

---Setting range---
0 to 3
12, 13, 21, 23, 31, 32

【#7951(PR)】 TIANGW2 Inclination angle

Set the inclination angle if the table rotating type workpiece-side rotary axis is inclined. Set the angle regarding CCW direction of the inclined plane as minus direction.

---Setting range---
-359.999 to 359.999 (°)
(Follow as "#1003 iunit Input setup unit".)

【#7952(PR)】 ROTAXW2 Rotary axis name

Set the name of the table rotating type workpiece-side rotary axis. Set "0" when the axis has the mechanical axis specifications. (The setting is, however, invalid in the tool center point control, R-Navi function.)

---Setting range---
0, A, B, C, U, V, W, X, Y, Z

【#7953】 DIR_W2 Rotation direction

Set the rotation direction for the table rotating type workpiece-side rotary axis.
0: CW
1: CCW

【#7954】 COFSW2H Horizontal axis rotation center offset

When all axes are at the machine basic point, set the distance in the horizontal axis direction between rotation centers of the base-side rotary axis and the workpiece-side rotary axis.

---Setting range---
-99999.999 to 99999.999 (mm)

【#7955】 COFSW2V Vertical axis rotation center offset

When all axes are at the machine basic point, set the distance in the vertical axis direction between rotation centers of the base-side rotary axis and the workpiece-side rotary axis.

---Setting range---
-99999.999 to 99999.999 (mm)

【#7956】 COFSW2T Height axis rotation center offset

When all axes are at the machine basic point, set the distance in the height axis direction between rotation centers of the base-side rotary axis and the workpiece-side rotary axis.

---Setting range---
-99999.999 to 99999.999 (mm)

【#7957】 CERRW2H Horizontal axis rotation center error compensation amount

Set the error compensation amount in the horizontal axis direction of the table rotating type workpiece-side rotary axis rotation center.

---Setting range---

-99999.999 to 99999.999 (mm)

【#7958】 CERRW2V Vertical axis rotation center error compensation amount

Set the error compensation amount in the vertical axis direction of the table rotating type workpiece-side rotary axis rotation center.

---Setting range---

-99999.999 to 99999.999 (mm)

2.8 Machine Error Compensation Parameters

The parameters with "(PR)" requires the CNC to be turned OFF after the settings. Turn the power OFF and ON to enable the parameter settings.

[#4000(PR)] Pinc Machine error compensation increment method

Select the method to set the machine error compensation data.
 0: Absolute amount method
 1: Incremental amount method

[#4001+10(n-1)] cmpax Basic axis <n-th axis>

Set a name of the basic axis for machine error compensation.
 (1) For pitch error compensation, set the name of the axis to be compensated.
 (2) For relative position compensation, set the name of the axis to be the basic axis.
 Set "system No. + axis name" when using the multi-part system.
 (Example) Z axis for 2nd part system: 2Z

When two or more same name exist, set "axis name + serial number".
 The serial number is common to all systems.
 (Example) If C axis of the 1st system has 2 axes, and another C axis in the 2nd system has 1 axis, set the C axis of the 2nd system as "C3".

---Setting range---
 Abbreviation as X, Y, Z, U, V, W, A, B, C, etc.

[#4002+10(n-1)] drcac Compensation axis <n-th axis>

Set a name of the compensation axis for machine error compensation.
 (1) For pitch error compensation, set the same axis name as in "#4001 cmpax".
 (2) For relative position compensation, set the name of the axis to be actually compensated.
 Set "system No. + axis name" when using the multi-part system.
 (Example) Z axis for 2nd part system: 2Z

When two or more same name exist, set "axis name + serial number".
 The serial number is common to all systems.
 (Example) If C axis of the 1st system has 2 axes, and another C axis in the 2nd system has 1 axis, set the C axis of the 2nd system as "C3".

---Setting range---
 Abbreviation as X, Y, Z, U, V, W, A, B, C, etc.

[#4003+10(n-1)] rdvno Division point number at reference position <n-th axis>

Set the compensation data No. corresponding to the reference position. As the reference position is actually the base position, there is no compensation No. Therefore set the number that is decremented by 1.
 (Note) When two-way pitch error compensation is enabled, set compensation data No. corresponding to reference point in shifting in plus direction.

---Setting range---
 When machine error compensation point extension option is disabled: 4101 to 5124
 When machine error compensation point extension option is enabled: 4101 to 5508

[#4004+10(n-1)] mdvno Division point number at the most negative side <n-th axis>

Set the compensation data No. at the farthest end on the negative side.
 (Note) When the axis moves in positive direction with two-way pitch error compensation enabled, set compensation data No. of which locates on the nearest point to negative side. The compensation point should be set with even number.

---Setting range---
 When machine error compensation point extension option is disabled: 4101 to 5124
 When machine error compensation point extension option is enabled: 4101 to 5508

【#4005+10(n-1)】 pdvno Division point number at the most positive side <n-th axis>

Set the compensation data No. at the farthest end on the positive side.

(Note) When the axis moves in negative direction with two-way pitch error compensation enabled, set compensation data No. of which locates on the nearest point to positive side. The compensation point should be set with even number.

---Setting range---

When machine error compensation point extension option is disabled: 4101 to 5124

When machine error compensation point extension option is enabled: 4101 to 5508

【#4006+10(n-1)】 sc Compensation scale factor <n-th axis>

Set the scale factor for the compensation amount.

---Setting range---

0 to 99

【#4007+10(n-1)】 spcdv Division interval <n-th axis>

Set the interval to divide the basic axis.

Each compensation data will be the compensation amount for each of these intervals.

---Setting range---

1 to 9999999 (control unit applied)

【#4008+10(n-1)】 twopc Two-way pitch error compensation <n-th axis>

Select whether to enable two-way pitch error compensation.

0: Disable

1: Enable

【#4009+10(n-1)】 refcmp Reference position compensation amount <n-th axis>

When two-way pitch error compensation is enabled, set the compensation amount of the reference position when the axis moves to the position from the opposite direction of the zero point return.

---Setting range---

-32768 to 32767

(Note) The actual compensation amount will be the value obtained by multiplying the setting value with the compensation scale.

【#4101 - 5124】

Set the compensation amount for each axis.

---Setting range---

-32768 to 32767

(Note1) The actual compensation amount will be the value obtained by multiplying the setting value with the compensation scale.

(Note2) With the cyclic error compensation function, the compensation unit will be fixed to 1/10000°.

2.9 PLC Constants

Some of the parameters may be fixed according to the usage purpose. Refer to "2.18 Table: "Contents of bit selection parameters #6449 to #6496"".

【#6401,6402 - 6495,6496】 R7800-Low,R7800-High - R7847-Low,R7847-High Bit selection

This is the bit type parameter used in the PLC program (ladder).

Even if the data is set in the R register that corresponds to the PLC side when this parameter is displayed, the screen will not change. Enter a different screen once, and then select this screen again.

Some of the parameters following #6449 may be fixed according to the usage purpose.

0 : OFF

1 : ON

【#6497,6498 - 6595,6596】 R7848-Low,R7848-High - R7897-Low,R7897-High Bit selection expansion

This is the bit type parameter (expansion) used in the PLC program (ladder).

Even if the data is set in the R register that corresponds to the PLC side when this parameter is displayed, the screen will not change. Enter a different screen once, and then select this screen again.

0 : OFF

1 : ON

[#16000 - 16703] T0 - T703 PLC timer <10ms/100ms>

Set the time for the timer used in the PLC program (ladder).

The 10ms timer and 100ms timer are identified by the command used.

(Note1) This setting value is valid when bit selection parameter "#6449/bit0" is set to "0".

(Note2) Setting the timer setting value from the setting and display unit

The timer T setting value can be set with the following two methods.

- Method to validate the setting value (Kn) programmed with the sequence program (fixed timer)

- Method to validate the setting value set from the setting and display unit (variable timer)

(Note3) As described bellow, the setting method of timer T and No. of points can be set with the bit selection parameters (#6454/bit0 to bit3).

- #6454/bit0=0, bit1=0, bit2=0, bit3=0

No. of points: 0

Range: None

Setting method: All fixed timers

- #6454/bit0=1, bit1=0, bit2=0, bit3=0

No. of points: 100

Range: #16000 to #16099

Setting method: Set above range with variable timers.

- #6454/bit0=0, bit1=1, bit2=0, bit3=0

No. of points: 200

Range: #16000 to #16199

Setting method: Set above range with variable timers.

- #6454/bit0=1, bit1=1, bit2=0, bit3=0

No. of points: 300

Range: #16000 to #16299

Setting method: Set above range with variable timers.

- #6454/bit0=0, bit1=0, bit2=1, bit3=0

No. of points: 400

Range: #16000 to #16399

Setting method: Set above range with variable timers.

- #6454/bit0=1, bit1=0, bit2=1, bit3=0

No. of points: 500

Range: #16000 to #16499

Setting method: Set above range with variable timers.

- #6454/bit0=0, bit1=1, bit2=1, bit3=0

No. of points: 600

Range: #16000 to #16599

Setting method: Set above range with variable timers.

- #6454/bit0=1, bit1=1, bit2=1, bit3=0

No. of points: All points

Range: #16000 to #16703

Setting method: All variable timers

---Setting range---

0 to 32767(x 10ms or x 100ms)

【#17000 - 17063】 ST0 - ST63 PLC integrated timer <100ms INC.>

Set the time for the integrated timer used with the PLC program (ladder).

(Note1) This setting value is valid when bit selection parameter "#6449/bit0" is set to "0".

(Note2) Setting the timer setting value from the setting and display unit

The timer T setting value can be set with the following two methods.

- Method to validate the setting value (Kn) programmed with the sequence program (fixed integrated timer)
- Method to validate the setting value set from the setting and display unit (variable integrated timer)

(Note3) As described bellow, the setting method of timer ST and No. of points can be set with the bit selection parameters (#6453/bit5 to bit7).

- #6453/bit5=0, bit6=0, bit7=0

No. of points: 0

Range: None

Setting method: All fixed integrated timers

- #6453/bit5=1, bit6=0, bit7=0

No. of points: 20

Range: #17000 to #17019

Setting method: Set above range with variable integrated timer.

- #6453/bit5=0, bit6=1, bit7=0

No. of points: 40

Range: #17000 to #17039

Setting method: Set above range with variable integrated timer.

- #6453/bit5=1, bit6=1, bit7=0

No. of points: All points

Range: #17000 to #17063

Setting method: All variable integrated timers

---Setting range---

0 to 32767(x 100ms)

【#17200 - 17455】 C000 - C255 Counter

Set the time for the counter used with the PLC program (ladder).

(Note1) This setting value is valid when bit selection parameter "#6449/bit1" is set to "0".

(Note2) Setting the counter setting value from the setting and display unit

The counter C setting value can be set with the following two methods.

- Method to validate the setting value (Kn) programmed with the sequence program (fixed counter)

- Method to validate the setting value set from the setting and display unit (variable counter)

(Note3) As described below, the setting method of counter C and No. of points can be set with the bit selection parameters (#6454/bit4 to bit7).

- #6454/bit4=0, bit5=0, bit6=0, bit7=0

No. of points: 0

Range: None

Setting method: All fixed counters

- #6454/bit4=1, bit5=0, bit6=0, bit7=0

No. of points: 40

Range: #17200 to #17239

Setting method: Set above range with variable counter.

- #6454/bit4=0, bit5=1, bit6=0, bit7=0

No. of points: 80

Range: #17200 to #17279

Setting method: Set above range with variable counter.

- #6454/bit4=1, bit5=1, bit6=0, bit7=0

No. of points: 120

Range: #17200 to #17319

Setting method: Set above range with variable counter.

- #6454/bit4=0, bit5=0, bit6=1, bit7=0

No. of points: 160

Range: #17200 to #17359

Setting method: Set above range with variable counter.

- #6454/bit4=1, bit5=0, bit6=1, bit7=0

No. of points: 200

Range: #17200 to #17399

Setting method: Set above range with variable counter.

- #6454/bit4=0, bit5=1, bit6=1, bit7=0

No. of points: 240

Range: #17200 to #17439

Setting method: Set above range with variable counter.

- #6454/bit4=1, bit5=1, bit6=1, bit7=0

No. of points: All points

Range: #17200 to #17455

Setting method: All variable counters

---Setting range---

0 to 32767

【#18001 - 18150】 R7500,7501 - R7798,7799 PLC constant

Set the value to be set in the data type R register used in the PLC program (ladder).

Even if the data is set in the R register that corresponds to the PLC side when this parameter is displayed. The screen will not change. Enter a different screen once, and then select this screen again.

---Setting range---

-99999999 to 99999999

【#18151-18900】 R8300,8301 - R9798,9799 PLC constant (Extension area)

Set the value to be set in the data type R register(R8300 to R9799) used in the PLC program (ladder).

Even if the data is set in the R register that corresponds to the PLC side when this parameter is displayed, the screen will not change. Enter a different screen once, and then select this screen again.

#18151 to #18900 is used as the PLC constant extended area.

The area is valid for the number of PLC constant extension points ("#1326 PLC Const Ext. Num" setting value), starting with #18151.

---Setting range---

-99999999 to 99999999

2.10 Macro List

【#7001】 M[01] Code

Set the M code used for calling out the macro with the M command.
 Select codes to be entered other than the codes basically required by the machine and M codes of M0, M1, M2, M30, M96 through M99, and M198.
 This is valid when "#1195 Mmac" is set to "1".

---Setting range---
 0 to 9999

【#7002】 M[01] Type

Set the macro call out type.

- 0: M98 P $\Delta\Delta\Delta\Delta$; and equivalent value call
- 1: G65 P $\Delta\Delta\Delta\Delta$; and equivalent value call
- 2: G66 P $\Delta\Delta\Delta\Delta$; and equivalent value call
- 3: G66.1 P $\Delta\Delta\Delta\Delta$; and equivalent value call
- others: M98 P $\Delta\Delta\Delta\Delta$; and equivalent value call

【#7003】 M[01] Program No.

Set the No. of the program to be called out.

---Setting range---
 1 to 99999999

【#7011】 M[02] Code

Set the M code used for calling out the macro with the M command.
 Select codes to be entered other than the codes basically required by the machine and M codes of M0, M1, M2, M30, M96 through M99, and M198.
 This is valid when "#1195 Mmac" is set to "1".

---Setting range---
 0 to 9999

【#7012】 M[02] Type

Set the macro call out type.

- 0: M98 P $\Delta\Delta\Delta\Delta$; and equivalent value call
- 1: G65 P $\Delta\Delta\Delta\Delta$; and equivalent value call
- 2: G66 P $\Delta\Delta\Delta\Delta$; and equivalent value call
- 3: G66.1 P $\Delta\Delta\Delta\Delta$; and equivalent value call
- others: M98 P $\Delta\Delta\Delta\Delta$; and equivalent value call

【#7013】 M[02] Program No.

Set the No. of the program to be called out.

---Setting range---
 1 to 99999999

【#7021】 M[03] Code

Set the M code used for calling out the macro with the M command.
 Select codes to be entered other than the codes basically required by the machine and M codes of M0, M1, M2, M30, M96 through M99, and M198.
 This is valid when "#1195 Mmac" is set to "1".

---Setting range---
 0 to 9999

【#7022】 M[03] Type

Set the macro call out type.

0: M98 P $\Delta\Delta\Delta\Delta$; and equivalent value call
 1: G65 P $\Delta\Delta\Delta\Delta$; and equivalent value call
 2: G66 P $\Delta\Delta\Delta\Delta$; and equivalent value call
 3: G66.1 P $\Delta\Delta\Delta\Delta$; and equivalent value call
 others: M98 P $\Delta\Delta\Delta\Delta$; and equivalent value call

【#7023】 M[03] Program No.

Set the No. of the program to be called out.

---Setting range---
 1 to 99999999

【#7031】 M[04] Code

Set the M code used for calling out the macro with the M command.

Select codes to be entered other than the codes basically required by the machine and M codes of M0, M1, M2, M30, M96 through M99, and M198.

This is valid when "#1195 Mmac" is set to "1".

---Setting range---
 0 to 9999

【#7032】 M[04] Type

Set the macro call out type.

0: M98 P $\Delta\Delta\Delta\Delta$; and equivalent value call
 1: G65 P $\Delta\Delta\Delta\Delta$; and equivalent value call
 2: G66 P $\Delta\Delta\Delta\Delta$; and equivalent value call
 3: G66.1 P $\Delta\Delta\Delta\Delta$; and equivalent value call
 others: M98 P $\Delta\Delta\Delta\Delta$; and equivalent value call

【#7033】 M[04] Program No.

Set the No. of the program to be called out.

---Setting range---
 1 to 99999999

【#7041】 M[05] Code

Set the M code used for calling out the macro with the M command.

Select codes to be entered other than the codes basically required by the machine and M codes of M0, M1, M2, M30, M96 through M99, and M198.

This is valid when "#1195 Mmac" is set to "1".

---Setting range---
 0 to 9999

【#7042】 M[05] Type

Set the macro call out type.

0: M98 P $\Delta\Delta\Delta\Delta$; and equivalent value call
 1: G65 P $\Delta\Delta\Delta\Delta$; and equivalent value call
 2: G66 P $\Delta\Delta\Delta\Delta$; and equivalent value call
 3: G66.1 P $\Delta\Delta\Delta\Delta$; and equivalent value call
 others: M98 P $\Delta\Delta\Delta\Delta$; and equivalent value call

【#7043】 M[05] Program No.

Set the No. of the program to be called out.

---Setting range---
 1 to 99999999

【#7051】 M[06] Code

Set the M code used for calling out the macro with the M command.
 Select codes to be entered other than the codes basically required by the machine and M codes of M0, M1, M2, M30, M96 through M99, and M198.
 This is valid when "#1195 Mmac" is set to "1".

---Setting range---

0 to 9999

【#7052】 M[06] Type

Set the macro call out type.

0: M98 P $\Delta\Delta\Delta\Delta$; and equivalent value call
 1: G65 P $\Delta\Delta\Delta\Delta$; and equivalent value call
 2: G66 P $\Delta\Delta\Delta\Delta$; and equivalent value call
 3: G66.1 P $\Delta\Delta\Delta\Delta$; and equivalent value call
 others: M98 P $\Delta\Delta\Delta\Delta$; and equivalent value call

【#7053】 M[06] Program No.

Set the No. of the program to be called out.

---Setting range---

1 to 99999999

【#7061】 M[07] Code

Set the M code used for calling out the macro with the M command.
 Select codes to be entered other than the codes basically required by the machine and M codes of M0, M1, M2, M30, M96 through M99, and M198.
 This is valid when "#1195 Mmac" is set to "1".

---Setting range---

0 to 9999

【#7062】 M[07] Type

Set the macro call out type.

0: M98 P $\Delta\Delta\Delta\Delta$; and equivalent value call
 1: G65 P $\Delta\Delta\Delta\Delta$; and equivalent value call
 2: G66 P $\Delta\Delta\Delta\Delta$; and equivalent value call
 3: G66.1 P $\Delta\Delta\Delta\Delta$; and equivalent value call
 others: M98 P $\Delta\Delta\Delta\Delta$; and equivalent value call

【#7063】 M[07] Program No.

Set the No. of the program to be called out.

---Setting range---

1 to 99999999

【#7071】 M[08] Code

Set the M code used for calling out the macro with the M command.
 Select codes to be entered other than the codes basically required by the machine and M codes of M0, M1, M2, M30, M96 through M99, and M198.
 This is valid when "#1195 Mmac" is set to "1".

---Setting range---

0 to 9999

【#7072】 M[08] Type

Set the macro call out type.

0: M98 P $\Delta\Delta\Delta\Delta$; and equivalent value call
 1: G65 P $\Delta\Delta\Delta\Delta$; and equivalent value call
 2: G66 P $\Delta\Delta\Delta\Delta$; and equivalent value call
 3: G66.1 P $\Delta\Delta\Delta\Delta$; and equivalent value call
 others: M98 P $\Delta\Delta\Delta\Delta$; and equivalent value call

【#7073】 M[08] Program No.

Set the No. of the program to be called out.

---Setting range---
 1 to 99999999

【#7081】 M[09] Code

Set the M code used for calling out the macro with the M command.

Select codes to be entered other than the codes basically required by the machine and M codes of M0, M1, M2, M30, M96 through M99, and M198.

This is valid when "#1195 Mmac" is set to "1".

---Setting range---
 0 to 9999

【#7082】 M[09] Type

Set the macro call out type.

0: M98 P $\Delta\Delta\Delta\Delta$; and equivalent value call
 1: G65 P $\Delta\Delta\Delta\Delta$; and equivalent value call
 2: G66 P $\Delta\Delta\Delta\Delta$; and equivalent value call
 3: G66.1 P $\Delta\Delta\Delta\Delta$; and equivalent value call
 others: M98 P $\Delta\Delta\Delta\Delta$; and equivalent value call

【#7083】 M[09] Program No.

Set the No. of the program to be called out.

---Setting range---
 1 to 99999999

【#7091】 M[10] Code

Set the M code used for calling out the macro with the M command.

Select codes to be entered other than the codes basically required by the machine and M codes of M0, M1, M2, M30, M96 through M99, and M198.

This is valid when "#1195 Mmac" is set to "1".

---Setting range---
 0 to 9999

【#7092】 M[10] Type

Set the macro call out type.

0: M98 P $\Delta\Delta\Delta\Delta$; and equivalent value call
 1: G65 P $\Delta\Delta\Delta\Delta$; and equivalent value call
 2: G66 P $\Delta\Delta\Delta\Delta$; and equivalent value call
 3: G66.1 P $\Delta\Delta\Delta\Delta$; and equivalent value call
 others: M98 P $\Delta\Delta\Delta\Delta$; and equivalent value call

【#7093】 M[10] Program No.

Set the No. of the program to be called out.

---Setting range---
 1 to 99999999

【#7102】 M2mac Type

Set the type for when calling out the macro with the 2nd miscellaneous command.
The macro will be called out with the "#1170 M2name" address command when "#1198 M2mac" is set to "1".

- 0: M98 P △△△△ ; and equivalent value call
- 1: G65 P △△△△ ; and equivalent value call
- 2: G66 P △△△△ ; and equivalent value call
- 3: G66.1 P △△△△ ; and equivalent value call
- others: M98 P △△△△ ; and equivalent value call

【#7103】 M2mac Program No.

Set the program No. for when calling out the macro with the 2nd miscellaneous command.
The macro will be called out with the "#1170 M2name" address command when "#1198 M2mac" is set to "1".
Set the No. of the program to be called out.

---Setting range---
1 to 99999999

【#7201】 G[01] Code

Set the G code to be used when calling the macro with a G command.
Do not set a G code used in the system.

---Setting range---
1 to 999

【#7202】 G[01] Type

Set the macro call out type.

- 0: M98 P △△△△ ; and equivalent value call
- 1: G65 P △△△△ ; and equivalent value call
- 2: G66 P △△△△ ; and equivalent value call
- 3: G66.1 P △△△△ ; and equivalent value call
- others: M98 P △△△△ ; and equivalent value call

【#7203】 G[01] Program No.

Set the No. of the program to be called out.

---Setting range---
1 to 99999999

【#7211】 G[02] Code

Set the G code to be used when calling the macro with a G command.
Do not set a G code used in the system.

---Setting range---
1 to 999

【#7212】 G[02] Type

Set the macro call out type.

- 0: M98 P △△△△ ; and equivalent value call
- 1: G65 P △△△△ ; and equivalent value call
- 2: G66 P △△△△ ; and equivalent value call
- 3: G66.1 P △△△△ ; and equivalent value call
- others: M98 P △△△△ ; and equivalent value call

【#7213】 G[02] Program No.

Set the No. of the program to be called out.

---Setting range---
1 to 99999999

【#7221】 G[03] Code

Set the G code to be used when calling the macro with a G command.
Do not set a G code used in the system.

---Setting range---
1 to 999

【#7222】 G[03] Type

Set the macro call out type.

0: M98 P $\Delta\Delta\Delta\Delta$; and equivalent value call
1: G65 P $\Delta\Delta\Delta\Delta$; and equivalent value call
2: G66 P $\Delta\Delta\Delta\Delta$; and equivalent value call
3: G66.1 P $\Delta\Delta\Delta\Delta$; and equivalent value call
others: M98 P $\Delta\Delta\Delta\Delta$; and equivalent value call

【#7223】 G[03] Program No.

Set the No. of the program to be called out.

---Setting range---
1 to 99999999

【#7231】 G[04] Code

Set the G code to be used when calling the macro with a G command.
Do not set a G code used in the system.

---Setting range---
1 to 999

【#7232】 G[04] Type

Set the macro call out type.

0: M98 P $\Delta\Delta\Delta\Delta$; and equivalent value call
1: G65 P $\Delta\Delta\Delta\Delta$; and equivalent value call
2: G66 P $\Delta\Delta\Delta\Delta$; and equivalent value call
3: G66.1 P $\Delta\Delta\Delta\Delta$; and equivalent value call
others: M98 P $\Delta\Delta\Delta\Delta$; and equivalent value call

【#7233】 G[04] Program No.

Set the No. of the program to be called out.

---Setting range---
1 to 99999999

【#7241】 G[05] Code

Set the G code to be used when calling the macro with a G command.
Do not set a G code used in the system.

---Setting range---
1 to 999

【#7242】 G[05] Type

Set the macro call out type.

- 0: M98 P $\Delta\Delta\Delta\Delta$; and equivalent value call
- 1: G65 P $\Delta\Delta\Delta\Delta$; and equivalent value call
- 2: G66 P $\Delta\Delta\Delta\Delta$; and equivalent value call
- 3: G66.1 P $\Delta\Delta\Delta\Delta$; and equivalent value call
- others: M98 P $\Delta\Delta\Delta\Delta$; and equivalent value call

【#7243】 G[05] Program No.

Set the No. of the program to be called out.

---Setting range---
1 to 99999999

【#7251】 G[06] Code

Set the G code to be used when calling the macro with a G command.
Do not set a G code used in the system.

---Setting range---
1 to 999

【#7252】 G[06] Type

Set the macro call out type.

- 0: M98 P $\Delta\Delta\Delta\Delta$; and equivalent value call
- 1: G65 P $\Delta\Delta\Delta\Delta$; and equivalent value call
- 2: G66 P $\Delta\Delta\Delta\Delta$; and equivalent value call
- 3: G66.1 P $\Delta\Delta\Delta\Delta$; and equivalent value call
- others: M98 P $\Delta\Delta\Delta\Delta$; and equivalent value call

【#7253】 G[06] Program No.

Set the No. of the program to be called out.

---Setting range---
1 to 99999999

【#7261】 G[07] Code

Set the G code to be used when calling the macro with a G command.
Do not set a G code used in the system.

---Setting range---
1 to 999

【#7262】 G[07] Type

Set the macro call out type.

- 0: M98 P $\Delta\Delta\Delta\Delta$; and equivalent value call
- 1: G65 P $\Delta\Delta\Delta\Delta$; and equivalent value call
- 2: G66 P $\Delta\Delta\Delta\Delta$; and equivalent value call
- 3: G66.1 P $\Delta\Delta\Delta\Delta$; and equivalent value call
- others: M98 P $\Delta\Delta\Delta\Delta$; and equivalent value call

【#7263】 G[07] Program No.

Set the No. of the program to be called out.

---Setting range---
1 to 99999999

【#7271】 G[08] Code

Set the G code to be used when calling the macro with a G command.
Do not set a G code used in the system.

---Setting range---
1 to 999

【#7272】 G[08] Type

Set the macro call out type.

0: M98 P $\Delta\Delta\Delta\Delta$; and equivalent value call
1: G65 P $\Delta\Delta\Delta\Delta$; and equivalent value call
2: G66 P $\Delta\Delta\Delta\Delta$; and equivalent value call
3: G66.1 P $\Delta\Delta\Delta\Delta$; and equivalent value call
others: M98 P $\Delta\Delta\Delta\Delta$; and equivalent value call

【#7273】 G[08] Program No.

Set the No. of the program to be called out.

---Setting range---
1 to 99999999

【#7281】 G[09] Code

Set the G code to be used when calling the macro with a G command.
Do not set a G code used in the system.

---Setting range---
1 to 999

【#7282】 G[09] Type

Set the macro call out type.

0: M98 P $\Delta\Delta\Delta\Delta$; and equivalent value call
1: G65 P $\Delta\Delta\Delta\Delta$; and equivalent value call
2: G66 P $\Delta\Delta\Delta\Delta$; and equivalent value call
3: G66.1 P $\Delta\Delta\Delta\Delta$; and equivalent value call
others: M98 P $\Delta\Delta\Delta\Delta$; and equivalent value call

【#7283】 G[09] Program No.

Set the No. of the program to be called out.

---Setting range---
1 to 99999999

【#7291】 G[10] Code

Set the G code to be used when calling the macro with a G command.
Do not set a G code used in the system.

---Setting range---
1 to 999

【#7292】 G[10] Type

Set the macro call out type.

0: M98 P $\Delta\Delta\Delta\Delta$; and equivalent value call
1: G65 P $\Delta\Delta\Delta\Delta$; and equivalent value call
2: G66 P $\Delta\Delta\Delta\Delta$; and equivalent value call
3: G66.1 P $\Delta\Delta\Delta\Delta$; and equivalent value call
others: M98 P $\Delta\Delta\Delta\Delta$; and equivalent value call

【#7293】 G[10] Program No.

Set the No. of the program to be called out.

---Setting range---

1 to 99999999

【#7302】 Smac Type

Set the type for when calling the macro with an S command.
This is valid when "#1196 Smac" is set to "1".

0: M98 P $\Delta\Delta\Delta\Delta$; and equivalent value call
1: G65 P $\Delta\Delta\Delta\Delta$; and equivalent value call
2: G66 P $\Delta\Delta\Delta\Delta$; and equivalent value call
3: G66.1 P $\Delta\Delta\Delta\Delta$; and equivalent value call
others: M98 P $\Delta\Delta\Delta\Delta$; and equivalent value call

【#7303】 Smac Program No.

Set the program No. for when calling the macro with an S command.
This is valid when "#1196 Smac" is set to "1".
Set the No. of the program to be called out.

---Setting range---

1 to 99999999

【#7312】 Tmac Type

Set the type for when calling the macro with a T command.
This is valid when "#1197 Tmac" is set to "1".

0: M98 P $\Delta\Delta\Delta\Delta$; and equivalent value call
1: G65 P $\Delta\Delta\Delta\Delta$; and equivalent value call
2: G66 P $\Delta\Delta\Delta\Delta$; and equivalent value call
3: G66.1 P $\Delta\Delta\Delta\Delta$; and equivalent value call
others: M98 P $\Delta\Delta\Delta\Delta$; and equivalent value call

【#7313】 Tmac Program No.

Set the program No. for when calling the macro with a T command.
This is valid when "#1197 Tmac" is set to "1".
Set the No. of the program to be called out.

---Setting range---

1 to 99999999

【#7401】 ASCII[01] Valid

The ASCII code macro parameters (#7402 to 7405) are validated.

0: Invalid
1: Valid

【#7402】 ASCII[01] Code

Set the ASCII code used to call macros with the ASCII code.

L system: A,B,D,F,H,I,J,K,M,Q,R,S,T
M system: A,B,F,H,I,K,M,Q,R,S,T

【#7403】 ASCII[01] Type

Set the macro call type.

0: M98
1: G65
2: G66
3: G66.1

【#7404】 ASCII[01] Program No.

Set the program No. called with macro call.

---Setting range---

Program name or file name (up to 32 characters)

【#7405】 ASCII[01] Variable

When the call type is "0", set the variable No. set after the ASCII code.

---Setting range---

100 to 149

【#7411】 ASCII[02] Valid

The ASCII code macro parameters (#7412 to 7415) are validated.

0: Invalid

1: Valid

【#7412】 ASCII[02] Code

Set the ASCII code used to call macros with the ASCII code.

L system: A,B,D,F,H,I,J,K,M,Q,R,S,T

M system: A,B,F,H,I,K,M,Q,R,S,T

【#7413】 ASCII[02] Type

Set the macro call type.

0: M98

1: G65

2: G66

3: G66.1

【#7414】 ASCII[02] Program No.

Set the program No. called with macro call.

---Setting range---

Program name or file name (up to 32 characters)

【#7415】 ASCII[02] Variable

When the call type is "0", set the variable No. set after the ASCII code.

---Setting range---

100 to 149

2.11 PLC Axis Indexing Parameters

【#12800(PR) chgauxno Auxiliary axis number

Set the axis No. to be controlled as auxiliary axis using auxiliary axis interface.
When "0" is set, the axis will not operate as auxiliary axis.

---Setting range---

Not used. Set to "0".

【#12801(PR) aux_station Number of indexing stations

Set the number of stations.
For linear axis, this value is expressed by: number of divisions = number of stations -1.
Setting "0" or "1" sets the number of stations to 2.

---Setting range---

0 to 360

【#12802(PR) aux_Cont1 Control parameter 1

The bits that are not explained here must be set to "0".

Bit3:

0: Automatic reach signal isn't interlocked with the start signal.
1: Automatic reach signal is interlocked with the start signal.

Bit4:

0: Automatic reach signal is turned ON again.
1: Automatic reach signal isn't turned ON again.

Bit5:

0: Station No. Output within fixed position.
1: Station No. Constantly output.

bit9:

0: Rotation direction determined by operation control signal (DIR)
1: Rotation direction in the shortcut direction

bitE:

0: Rotation direction in operation control signal (DIR) or in the shortcut direction
1: Rotation direction in the arbitrary position command sign direction

bitF:

0: Stopper direction is in the positioning direction.
1: Stopper direction is in the sign direction of the stopper amount.

【#12803(PR) aux_Cont2 Control parameter 2

The bits that are not explained here must be set to "0".

bit4:

0: Uniform assignment
1: Arbitrary coordinate assignment

【#12804(PR) aux_tleng Linear axis stroke length

Set the movement stroke length for linear axes.
(Note 1)Setting "0.000" causes an MCP alarm at the power ON.
(Note 2)This parameter is meaningless at the arbitrary coordinate assignment or with the arbitrary coordinate designation method.

---Setting range---

0.000 to 99999.999 (mm)

【#12805】 aux_ST.offset Station offset

Set the distance (offset) from the reference position to station 1.

---Setting range---

-99999.999 to 99999.999 (° or mm)

【#12810+10(n-1)】 aux_Aspeedn Operation parameter group n Automatic operation speed

Set the feedrate during automatic operation when "operation parameter group n" is selected. "#12810 aux_Aspeed1" is regarded as the clamp value for the automatic operation speeds and manual operation speeds of all operation groups.

A speed exceeding "aux_Aspeed1" cannot be commanded, even if it is set in a parameter.

(Note)Setting "0" causes an operation error at the "Operation start" signal's ON.

---Setting range---

0 to 100000 (°/min or mm/min)

【#12811+10(n-1)】 aux_Mspeedn Operation parameter group n Manual operation speed

Set the feedrate during manual operation or JOG operation when "operation parameter group n" is selected.

(Note)Setting "0" causes an operation error at the "Operation start" signal's ON.

---Setting range---

0 to 100000 (°/min or mm/min)

【#12812+10(n-1)】 aux_timen.1 Operation parameter group n Acceleration/deceleration time constant 1

Set the linear acceleration/deceleration time for "Operation parameter group 1 automatic operation speed" (clamp speed) when "operation parameter group n" is selected.

When this is set with "Acceleration/deceleration time constant 2", S-pattern acceleration/deceleration will be carried out. In this case, this parameter determines the acceleration/deceleration time of the linear part.

When operating at a speed less than the clamp speed, if "#1361 aux_acc" is set to "0", the axis will accelerate/decelerate with the time constant set in this parameter. If "#1361 aux_acc" is set to "1", the axis will accelerate/decelerate at the constant inclination determined by this parameter and "aux_Aspeed1".

Setting "0" cancels acceleration/deceleration: The axis will move with the time constant "0".

---Setting range---

0 to 4000 (ms)

【#12813+10(n-1)】 aux_timen.2 Operation parameter group n Acceleration/deceleration time constant 2

Set the total time of the non-linear parts in the S-pattern acceleration/deceleration.

In the handle feed operation mode, this setting value is regarded as time constant for the linear acceleration/deceleration.

(Note)If this parameter is set to "0" while "#12818 aux_smgst1" is set to "F", an MCP alarm will occur.

---Setting range---

0 to 4000 (ms)

【#12814+10(n-1)】 aux_TLn Operation parameter group n Torque limit value

Set the motor output torque limit value when "operation parameter group n" is selected.

At the default value, the torque is limited at the maximum torque of the motor specifications. Set the default value when torque limit is not especially required.

In the stopper positioning operation mode, this will be regarded as torque limit value when positioning to the stopper starting coordinates.

---Setting range---

0 to 500 (%)

【#12815+10(n-1) aux_ODn Operation parameter group n Excessive error detection width

Set the excessive error detection width when "operation parameter group n" is selected.
The excessive error alarm (S03 0052) will be detected when the position droop becomes larger than this setting value.
In the stopper positioning operation mode, this will be regarded as excessive error detection width when positioning to the stopper starting coordinates. .

---Setting range---

0 to 32767(° or mm)

【#12816+10(n-1) aux_justn Operation parameter group n Set position output width

Set the tolerable value at which "set position reached" (JST) or "automatic set position reached" (JSTA) signal is output when "operation parameter group n" is selected.
"Set position reached" (JST) indicates that the machine position is at any station.
During automatic operation, "automatic set position reached" (JSTA) is also output under the same condition.
These signals will turn OFF when the machine position moves away from the station over this value.

---Setting range---

0.000 to 99999.999(° or mm)

【#12817+10(n-1) aux_nearn Operation parameter group n Near set position output width

Set the tolerable value at which "near set position" (NEAR) signal is output when "operation parameter group n" is selected.
"Near set position" (NEAR) indicates that the machine position is near any station position.
This value is generally set wider than the set position output width. During operations, this is related to the special commands when the station selection is set to "0".

---Setting range---

0.000 to 99999.999(° or mm)

【#12818+10(n-1)(PR) aux_smgstn Operation parameter group n Acceleration/Deceleration type

Select the acceleration/deceleration type when "operation parameter group n" is selected.
0, 1: Linear acceleration/deceleration
F: S-pattern acceleration/deceleration

【#12850] aux_stpos2 Station 2 coordinate

Set the station 2 coordinate value when arbitrary coordinate assignment is selected.
The station 1 coordinate value is fixed at "0.000" (machine coordinate zero point).

---Setting range---

-99999.999 to 99999.999(° or mm)

【#12851] aux_stpos3 Station 3 coordinate

Set the station 3 coordinate value when arbitrary coordinate assignment is selected.
The station 1 coordinate value is fixed at "0.000" (machine coordinate zero point).

---Setting range---

-99999.999 to 99999.999(° or mm)

【#12852] aux_stpos4 Station 4 coordinate

Set the station 4 coordinate value when arbitrary coordinate assignment is selected.
The station 1 coordinate value is fixed at "0.000" (machine coordinate zero point).

---Setting range---

-99999.999 to 99999.999(° or mm)

【#12853] aux_stpos5 Station 5 coordinate

Set the station 5 coordinate value when arbitrary coordinate assignment is selected.
The station 1 coordinate value is fixed at "0.000" (machine coordinate zero point).

---Setting range---

-99999.999 to 99999.999(° or mm)

【#12854】 aux_stpos6 Station 6 coordinate

Set the station 6 coordinate value when arbitrary coordinate assignment is selected.
The station 1 coordinate value is fixed at "0.000" (machine coordinate zero point).

---Setting range---

-99999.999 to 99999.999(° or mm)

【#12855】 aux_stpos7 Station 7 coordinate

Set the station 7 coordinate value when arbitrary coordinate assignment is selected.
The station 1 coordinate value is fixed at "0.000" (machine coordinate zero point).

---Setting range---

-99999.999 to 99999.999(° or mm)

【#12856】 aux_stpos8 Station 8 coordinate

Set the station 8 coordinate value when arbitrary coordinate assignment is selected.
The station 1 coordinate value is fixed at "0.000" (machine coordinate zero point).

---Setting range---

-99999.999 to 99999.999(° or mm)

【#12857】 aux_stpos9 Station 9 coordinate

Set the coordinate of each station when arbitrary coordinate assignment is selected.
The station 1 coordinate value is fixed at "0.000" (machine coordinate zero point).

---Setting range---

-99999.999 to 99999.999(° or mm)

【#12858】 aux_stpos10 Station 10 coordinate

Set the station 10 coordinate value when arbitrary coordinate assignment is selected.
The station 1 coordinate value is fixed at "0.000" (machine coordinate zero point).

---Setting range---

-99999.999 to 99999.999(° or mm)

【#12859】 aux_stpos11 Station 11 coordinate

Set the station 11 coordinate value when arbitrary coordinate assignment is selected.
The station 1 coordinate value is fixed at "0.000" (machine coordinate zero point).

---Setting range---

-99999.999 to 99999.999(° or mm)

【#12860】 aux_stpos12 Station 12 coordinate

Set the station 12 coordinate value when arbitrary coordinate assignment is selected.
The station 1 coordinate value is fixed at "0.000" (machine coordinate zero point).

---Setting range---

-99999.999 to 99999.999(° or mm)

【#12861】 aux_stpos13 Station 13 coordinate

Set the station 13 coordinate value when arbitrary coordinate assignment is selected.
The station 1 coordinate value is fixed at "0.000" (machine coordinate zero point).

---Setting range---

-99999.999 to 99999.999(° or mm)

【#12862】 aux_stpos14 Station 14 coordinate

Set the station 14 coordinate value when arbitrary coordinate assignment is selected.
The station 1 coordinate value is fixed at "0.000" (machine coordinate zero point).

---Setting range---

-99999.999 to 99999.999(° or mm)

【#12863】 aux_stpos15 Station 15 coordinate

Set the station 15 coordinate value when arbitrary coordinate assignment is selected.
The station 1 coordinate value is fixed at "0.000" (machine coordinate zero point).

---Setting range---
-99999.999 to 99999.999(° or mm)

【#12864】 aux_stpos16 Station 16 coordinate

Set the station 16 coordinate value when arbitrary coordinate assignment is selected.
The station 1 coordinate value is fixed at "0.000" (machine coordinate zero point).

---Setting range---
-99999.999 to 99999.999(° or mm)

【#12865】 aux_stpos17 Station 17 coordinate

Set the station 17 coordinate value when arbitrary coordinate assignment is selected.
The station 1 coordinate value is fixed at "0.000" (machine coordinate zero point).

---Setting range---
-99999.999 to 99999.999(° or mm)

【#12866】 aux_stpos18 Station 18 coordinate

Set the station 18 coordinate value when arbitrary coordinate assignment is selected.
The station 1 coordinate value is fixed at "0.000" (machine coordinate zero point).

---Setting range---
-99999.999 to 99999.999(° or mm)

【#12867】 aux_stpos19 Station 19 coordinate

Set the station 19 coordinate value when arbitrary coordinate assignment is selected.
The station 1 coordinate value is fixed at "0.000" (machine coordinate zero point).

---Setting range---
-99999.999 to 99999.999(° or mm)

【#12868】 aux_stpos20 Station 20 coordinate

Set the station 20 coordinate value when arbitrary coordinate assignment is selected.
The station 1 coordinate value is fixed at "0.000" (machine coordinate zero point).

---Setting range---
-99999.999 to 99999.999(° or mm)

【#12870】 aux_PSWcheck PSW detection method

Select the criterion for the output of position switches 1 to 15.
bit0 to E correspond to position switches 1 to 15.
0: Judged by the machine position of the command system.
1: Judged by the machine FB position (actual position).

(Note) The bits that are not explained here must be set to "0".

【#12871】 aux_PSW1dog1 PSW1 area setting 1

Set "PSW1 area setting" 1 and 2 to specify the area where the position switch 1 will turn ON when the machine is positioned.
Whether the value of setting 1 is larger than setting 2 (or vice versa) does not affect the position switch operation.
For rotary axes, the output turns ON in the area excluding 0.000 degree.

---Setting range---
-99999.999 to 99999.999(° or mm)

【#12872】 aux_PSW1dog2 PSW1 area setting 2

Set "PSW1 area setting" 1 and 2 to specify the area where the position switch 1 will turn ON when the machine is positioned.

Whether the value of setting 1 is larger than setting 2 (or vice versa) does not affect the position switch operation.

For rotary axes, the output turns ON in the area excluding 0.000 degree.

---Setting range---

-99999.999 to 99999.999(° or mm)

【#12873】 aux_PSW2dog1 PSW2 area setting 1

Set "PSW2 area setting" 1 and 2 to specify the area where the position switch 2 will turn ON when the machine is positioned.

Whether the value of setting 1 is larger than setting 2 (or vice versa) does not affect the position switch operation.

For rotary axes, the output turns ON in the area excluding 0.000 degree.

---Setting range---

-99999.999 to 99999.999(° or mm)

【#12874】 aux_PSW2dog2 PSW2 area setting 2

Set "PSW2 area setting" 1 and 2 to specify the area where the position switch 2 will turn ON when the machine is positioned.

Whether the value of setting 1 is larger than setting 2 (or vice versa) does not affect the position switch operation.

For rotary axes, the output turns ON in the area excluding 0.000 degree.

---Setting range---

-99999.999 to 99999.999(° or mm)

【#12875】 aux_PSW3dog1 PSW3 area setting 1

Set "PSW3 area setting" 1 and 2 to specify the area where the position switch 3 will turn ON when the machine is positioned.

Whether the value of setting 1 is larger than setting 2 (or vice versa) does not affect the position switch operation.

For rotary axes, the output turns ON in the area excluding 0.000 degree.

---Setting range---

-99999.999 to 99999.999(° or mm)

【#12876】 aux_PSW3dog2 PSW3 area setting 2

Set "PSW3 area setting" 1 and 2 to specify the area where the position switch 3 will turn ON when the machine is positioned.

Whether the value of setting 1 is larger than setting 2 (or vice versa) does not affect the position switch operation.

For rotary axes, the output turns ON in the area excluding 0.000 degree.

---Setting range---

-99999.999 to 99999.999(° or mm)

【#12877】 aux_PSW4dog1 PSW4 area setting 1

Set "PSW4 area setting" 1 and 2 to specify the area where the position switch 4 will turn ON when the machine is positioned.

Whether the value of setting 1 is larger than setting 2 (or vice versa) does not affect the position switch operation.

For rotary axes, the output turns ON in the area excluding 0.000 degree.

---Setting range---

-99999.999 to 99999.999(° or mm)

【#12878】 aux_PSW4dog2 PSW4 area setting 2

Set "PSW4 area setting" 1 and 2 to specify the area where the position switch 4 will turn ON when the machine is positioned.
 Whether the value of setting 1 is larger than setting 2 (or vice versa) does not affect the position switch operation.
 For rotary axes, the output turns ON in the area excluding 0.000 degree.

---Setting range---

-99999.999 to 99999.999(° or mm)

【#12879】 aux_PSW5dog1 PSW5 area setting 1

Set "PSW5 area setting" 1 and 2 to specify the area where the position switch 5 will turn ON when the machine is positioned.
 Whether the value of setting 1 is larger than setting 2 (or vice versa) does not affect the position switch operation.
 For rotary axes, the output turns ON in the area excluding 0.000 degree.

---Setting range---

-99999.999 to 99999.999(° or mm)

【#12880】 aux_PSW5dog2 PSW5 area setting 2

Set "PSW5 area setting" 1 and 2 to specify the area where the position switch 5 will turn ON when the machine is positioned.
 Whether the value of setting 1 is larger than setting 2 (or vice versa) does not affect the position switch operation.
 For rotary axes, the output turns ON in the area excluding 0.000 degree.

---Setting range---

-99999.999 to 99999.999(° or mm)

【#12881】 aux_PSW6dog1 PSW6 area setting 1

Set "PSW6 area setting" 1 and 2 to specify the area where the position switch 6 will turn ON when the machine is positioned.
 Whether the value of setting 1 is larger than setting 2 (or vice versa) does not affect the position switch operation.
 For rotary axes, the output turns ON in the area excluding 0.000 degree.

---Setting range---

-99999.999 to 99999.999(° or mm)

【#12882】 aux_PSW6dog2 PSW6 area setting 2

Set "PSW6 area setting" 1 and 2 to specify the area where the position switch 6 will turn ON when the machine is positioned.
 Whether the value of setting 1 is larger than setting 2 (or vice versa) does not affect the position switch operation.
 For rotary axes, the output turns ON in the area excluding 0.000 degree.

---Setting range---

-99999.999 to 99999.999(° or mm)

【#12883】 aux_PSW7dog1 PSW7 area setting 1

Set "PSW7 area setting" 1 and 2 to specify the area where the position switch 7 will turn ON when the machine is positioned.
 Whether the value of setting 1 is larger than setting 2 (or vice versa) does not affect the position switch operation.
 For rotary axes, the output turns ON in the area excluding 0.000 degree.

---Setting range---

-99999.999 to 99999.999(° or mm)

【#12884】 aux_PSW7dog2 PSW7 area setting 2

Set "PSW7 area setting" 1 and 2 to specify the area where the position switch 7 will turn ON when the machine is positioned.

Whether the value of setting 1 is larger than setting 2 (or vice versa) does not affect the position switch operation.

For rotary axes, the output turns ON in the area excluding 0.000 degree.

---Setting range---

-99999.999 to 99999.999(° or mm)

【#12885】 aux_PSW8dog1 PSW8 area setting 1

Set "PSW8 area setting" 1 and 2 to specify the area where the position switch 8 will turn ON when the machine is positioned.

Whether the value of setting 1 is larger than setting 2 (or vice versa) does not affect the position switch operation.

For rotary axes, the output turns ON in the area excluding 0.000 degree.

---Setting range---

-99999.999 to 99999.999(° or mm)

【#12886】 aux_PSW8dog2 PSW8 area setting 2

Set "PSW8 area setting" 1 and 2 to specify the area where the position switch 8 will turn ON when the machine is positioned.

Whether the value of setting 1 is larger than setting 2 (or vice versa) does not affect the position switch operation.

For rotary axes, the output turns ON in the area excluding 0.000 degree.

---Setting range---

-99999.999 to 99999.999(° or mm)

【#12887】 aux_PSW9dog1 PSW9 area setting 1

Set "PSW9 area setting" 1 and 2 to specify the area where the position switch 9 will turn ON when the machine is positioned.

Whether the value of setting 1 is larger than setting 2 (or vice versa) does not affect the position switch operation.

For rotary axes, the output turns ON in the area excluding 0.000 degree.

---Setting range---

-99999.999 to 99999.999(° or mm)

【#12888】 aux_PSW9dog2 PSW9 area setting 2

Set "PSW9 area setting" 1 and 2 to specify the area where the position switch 9 will turn ON when the machine is positioned.

Whether the value of setting 1 is larger than setting 2 (or vice versa) does not affect the position switch operation.

For rotary axes, the output turns ON in the area excluding 0.000 degree.

---Setting range---

-99999.999 to 99999.999(° or mm)

【#12889】 aux_PSW10dog1 PSW10 area setting 1

Set "PSW10 area setting" 1 and 2 to specify the area where the position switch 10 will turn ON when the machine is positioned.

Whether the value of setting 1 is larger than setting 2 (or vice versa) does not affect the position switch operation.

For rotary axes, the output turns ON in the area excluding 0.000 degree.

---Setting range---

-99999.999 to 99999.999(° or mm)

【#12890】 aux_PSW10dog2 PSW10 area setting 2

Set "PSW10 area setting" 1 and 2 to specify the area where the position switch 10 will turn ON when the machine is positioned.
 Whether the value of setting 1 is larger than setting 2 (or vice versa) does not affect the position switch operation.
 For rotary axes, the output turns ON in the area excluding 0.000 degree.

---Setting range---

-99999.999 to 99999.999(° or mm)

【#12891】 aux_PSW11dog1 PSW11 area setting 1

Set "PSW11 area setting" 1 and 2 to specify the area where the position switch 11 will turn ON when the machine is positioned.
 Whether the value of setting 1 is larger than setting 2 (or vice versa) does not affect the position switch operation.
 For rotary axes, the output turns ON in the area excluding 0.000 degree.

---Setting range---

-99999.999 to 99999.999(° or mm)

【#12892】 aux_PSW11dog2 PSW11 area setting 2

Set "PSW11 area setting" 1 and 2 to specify the area where the position switch 11 will turn ON when the machine is positioned.
 Whether the value of setting 1 is larger than setting 2 (or vice versa) does not affect the position switch operation.
 For rotary axes, the output turns ON in the area excluding 0.000 degree.

---Setting range---

-99999.999 to 99999.999(° or mm)

【#12893】 aux_PSW12dog1 PSW12 area setting 1

Set "PSW12 area setting" 1 and 2 to specify the area where the position switch 12 will turn ON when the machine is positioned.
 Whether the value of setting 1 is larger than setting 2 (or vice versa) does not affect the position switch operation.
 For rotary axes, the output turns ON in the area excluding 0.000 degree.

---Setting range---

-99999.999 to 99999.999(° or mm)

【#12894】 aux_PSW12dog2 PSW12 area setting 2

Set "PSW12 area setting" 1 and 2 to specify the area where the position switch 12 will turn ON when the machine is positioned.
 Whether the value of setting 1 is larger than setting 2 (or vice versa) does not affect the position switch operation.
 For rotary axes, the output turns ON in the area excluding 0.000 degree.

---Setting range---

-99999.999 to 99999.999(° or mm)

【#12895】 aux_PSW13dog1 PSW13 area setting 1

Set "PSW13 area setting" 1 and 2 to specify the area where the position switch 13 will turn ON when the machine is positioned.
 Whether the value of setting 1 is larger than setting 2 (or vice versa) does not affect the position switch operation.
 For rotary axes, the output turns ON in the area excluding 0.000 degree.

---Setting range---

-99999.999 to 99999.999(° or mm)

【#12896】 aux_PSW13dog2 PSW13 area setting 2

Set "PSW13 area setting" 1 and 2 to specify the area where the position switch 13 will turn ON when the machine is positioned.

Whether the value of setting 1 is larger than setting 2 (or vice versa) does not affect the position switch operation.

For rotary axes, the output turns ON in the area excluding 0.000 degree.

---Setting range---

-99999.999 to 99999.999(° or mm)

【#12897】 aux_PSW14dog1 PSW14 area setting 1

Set "PSW14 area setting" 1 and 2 to specify the area where the position switch 14 will turn ON when the machine is positioned.

Whether the value of setting 1 is larger than setting 2 (or vice versa) does not affect the position switch operation.

For rotary axes, the output turns ON in the area excluding 0.000 degree.

---Setting range---

-99999.999 to 99999.999(° or mm)

【#12898】 aux_PSW14dog2 PSW14 area setting 2

Set "PSW14 area setting" 1 and 2 to specify the area where the position switch 14 will turn ON when the machine is positioned.

Whether the value of setting 1 is larger than setting 2 (or vice versa) does not affect the position switch operation.

For rotary axes, the output turns ON in the area excluding 0.000 degree.

---Setting range---

-99999.999 to 99999.999(° or mm)

【#12899】 aux_PSW15dog1 PSW15 area setting 1

Set "PSW15 area setting" 1 and 2 to specify the area where the position switch 15 will turn ON when the machine is positioned.

Whether the value of setting 1 is larger than setting 2 (or vice versa) does not affect the position switch operation.

For rotary axes, the output turns ON in the area excluding 0.000 degree.

---Setting range---

-99999.999 to 99999.999(° or mm)

【#12900】 aux_PSW15dog2 PSW15 area setting 2

Set "PSW15 area setting" 1 and 2 to specify the area where the position switch 15 will turn ON when the machine is positioned.

Whether the value of setting 1 is larger than setting 2 (or vice versa) does not affect the position switch operation.

For rotary axes, the output turns ON in the area excluding 0.000 degree.

---Setting range---

-99999.999 to 99999.999(° or mm)

【#12910】 aux_push Stopper amount

Set the command stroke of the stopper operation in the stopper positioning.

---Setting range---

0.000 to 359.999(° or mm)

【#12911】 aux_pusht1 Stopper standby time

Set the standby time from the stopper starting coordinate positioning to the stopper operation start in the stopper positioning.

---Setting range---

0 to 9999(ms)

【#12912】 aux_pusht2 Stopper torque release time

Set the time from the completion of the stopper operation to the changeover of the stopper torque in the stopper positioning.

---Setting range---

0 to 9999(ms)

【#12913】 aux_pusht3 Set position signal output delay time

Set the time from the completion of the stopper operation to the output of the "automatic set position reached" (JSTA), "set position reached" (JST) or "near set position" (NEAR) signal in the stopper positioning.

---Setting range---

0 to 9999(ms)

2.12 Position Switches

【#7500】 Pcheck High-speed switching of position switch

Specify whether to perform position switch area checking at high speeds.

0: Do not perform position switch area checking at high speed (do it the same as before).

1: Perform position switch area checking at high speed.

【#7501】 PSW1 axis Axis name

Specify the name of the axis for which a position switch is provided.

---Setting range---

X, Y, Z, U, V, W, A, B, or C axis address

【#7502】 PSW1 dog1 Imaginary dog position 1

When the machine enters the range between imaginary dog positions 1 and 2, a signal is output to the PLC.

1st part system device: X1D00

2nd part system device: X1D20

---Setting range---

-99999.999 to 99999.999 (mm)

【#7503】 PSW1 dog2 Imaginary dog position 2

When the machine enters the range between imaginary dog positions 1 and 2, a signal is output to the PLC.

1st part system device: X1D00

2nd part system device: X1D20

---Setting range---

-99999.999 to 99999.999 (mm)

【#7504】 PSW1 check Selection of area check method

When position switch area checking at high speed is selected, specify the mode of area checking, i.e., whether to use the command type machine position or detector feedback position, for each position switch point.

0: Use the command type machine position as the machine position for position switch area checking.

1: Use the detector feedback position as the machine position for position switch area checking.

(Note) This parameter is valid only when "1" set in "#7500 Pcheck".

【#7511】 PSW2 axis Axis name

Specify the name of the axis for which a position switch is provided.

---Setting range---

X, Y, Z, U, V, W, A, B, or C axis address

【#7512】 PSW2 dog1 Imaginary dog position 1

When the machine enters the range between imaginary dog positions 1 and 2, a signal is output to the PLC.

1st part system device: X1D01

2nd part system device: X1D21

---Setting range---

-99999.999 to 99999.999 (mm)

【#7513】 PSW2 dog2 Imaginary dog position 2

When the machine enters the range between imaginary dog positions 1 and 2, a signal is output to the PLC.

1st part system device: X1D01

2nd part system device: X1D21

---Setting range---

-99999.999 to 99999.999 (mm)

【#7514】 PSW2 check Selection of area check method

When position switch area checking at high speed is selected, specify the mode of area checking, i.e., whether to use the command type machine position or detector feedback position, for each position switch point.

0: Use the command type machine position as the machine position for position switch area checking.

1: Use the detector feedback position as the machine position for position switch area checking.

(Note) This parameter is valid only when "1" set in "#7500 Pcheck".

【#7521】 PSW3 axis Axis name

Specify the name of the axis for which a position switch is provided.

---Setting range---

X, Y, Z, U, V, W, A, B, or C axis address

【#7522】 PSW3 dog1 Imaginary dog position 1

When the machine enters the range between imaginary dog positions 1 and 2, a signal is output to the PLC.

1st part system device: X1D02

2nd part system device: X1D22

---Setting range---

-99999.999 to 99999.999 (mm)

【#7523】 PSW3 dog2 Imaginary dog position 2

When the machine enters the range between imaginary dog positions 1 and 2, a signal is output to the PLC.

1st part system device: X1D02

2nd part system device: X1D22

---Setting range---

-99999.999 to 99999.999 (mm)

【#7524】 PSW3 check Selection of area check method

When position switch area checking at high speed is selected, specify the mode of area checking, i.e., whether to use the command type machine position or detector feedback position, for each position switch point.

0: Use the command type machine position as the machine position for position switch area checking.

1: Use the detector feedback position as the machine position for position switch area checking.

(Note) This parameter is valid only when "1" set in "#7500 Pcheck".

【#7531】 PSW4 axis Axis name

Specify the name of the axis for which a position switch is provided.

---Setting range---

X, Y, Z, U, V, W, A, B, or C axis address

【#7532】 PSW4 dog1 Imaginary dog position 1

When the machine enters the range between imaginary dog positions 1 and 2, a signal is output to the PLC.

1st part system device: X1D03

2nd part system device: X1D23

---Setting range---

-99999.999 to 99999.999 (mm)

【#7533】 PSW4 dog2 Imaginary dog position 2

When the machine enters the range between imaginary dog positions 1 and 2, a signal is output to the PLC.

1st part system device: X1D03

2nd part system device: X1D23

---Setting range---

-99999.999 to 99999.999 (mm)

【#7534】 PSW4 check Selection of area check method

When position switch area checking at high speed is selected, specify the mode of area checking, i.e., whether to use the command type machine position or detector feedback position, for each position switch point.

0: Use the command type machine position as the machine position for position switch area checking.

1: Use the detector feedback position as the machine position for position switch area checking.

(Note) This parameter is valid only when "1" set in "#7500 Pcheck".

【#7541】 PSW5 axis Axis name

Specify the name of the axis for which a position switch is provided.

---Setting range---

X, Y, Z, U, V, W, A, B, or C axis address

【#7542】 PSW5 dog1 Imaginary dog position 1

When the machine enters the range between imaginary dog positions 1 and 2, a signal is output to the PLC.

1st part system device: X1D04

2nd part system device: X1D24

---Setting range---

-99999.999 to 99999.999 (mm)

【#7543】 PSW5 dog2 Imaginary dog position 2

When the machine enters the range between imaginary dog positions 1 and 2, a signal is output to the PLC.

1st part system device: X1D04

2nd part system device: X1D24

---Setting range---

-99999.999 to 99999.999 (mm)

【#7544】 PSW5 check Selection of area check method

When position switch area checking at high speed is selected, specify the mode of area checking, i.e., whether to use the command type machine position or detector feedback position, for each position switch point.

0: Use the command type machine position as the machine position for position switch area checking.

1: Use the detector feedback position as the machine position for position switch area checking.

(Note) This parameter is valid only when "1" set in "#7500 Pcheck".

【#7551】 PSW6 axis Axis name

Specify the name of the axis for which a position switch is provided.

---Setting range---

X, Y, Z, U, V, W, A, B, or C axis address

【#7552】 PSW6 dog1 Imaginary dog position 1

When the machine enters the range between imaginary dog positions 1 and 2, a signal is output to the PLC.

1st part system device: X1D05

2nd part system device: X1D25

---Setting range---

-99999.999 to 99999.999 (mm)

【#7553】 PSW6 dog2 Imaginary dog position 2

When the machine enters the range between imaginary dog positions 1 and 2, a signal is output to the PLC.

1st part system device: X1D05

2nd part system device: X1D25

---Setting range---

-99999.999 to 99999.999 (mm)

【#7554】 PSW6 check Selection of area check method

When position switch area checking at high speed is selected, specify the mode of area checking, i.e., whether to use the command type machine position or detector feedback position, for each position switch point.

0: Use the command type machine position as the machine position for position switch area checking.

1: Use the detector feedback position as the machine position for position switch area checking.

(Note) This parameter is valid only when "1" set in "#7500 Pcheck".

【#7561】 PSW7 axis Axis name

Specify the name of the axis for which a position switch is provided.

---Setting range---

X, Y, Z, U, V, W, A, B, or C axis address

【#7562】 PSW7 dog1 Imaginary dog position 1

When the machine enters the range between imaginary dog positions 1 and 2, a signal is output to the PLC.

1st part system device: X1D06

2nd part system device: X1D26

---Setting range---

-99999.999 to 99999.999 (mm)

【#7563】 PSW7 dog2 Imaginary dog position 2

When the machine enters the range between imaginary dog positions 1 and 2, a signal is output to the PLC.

1st part system device: X1D06

2nd part system device: X1D26

---Setting range---

-99999.999 to 99999.999 (mm)

【#7564】 PSW7 check Selection of area check method

When position switch area checking at high speed is selected, specify the mode of area checking, i.e., whether to use the command type machine position or detector feedback position, for each position switch point.

0: Use the command type machine position as the machine position for position switch area checking.

1: Use the detector feedback position as the machine position for position switch area checking.

(Note) This parameter is valid only when "1" set in "#7500 Pcheck".

【#7571】 PSW8 axis Axis name

Specify the name of the axis for which a position switch is provided.

---Setting range---

X, Y, Z, U, V, W, A, B, or C axis address

【#7572】 PSW8 dog1 Imaginary dog position 1

When the machine enters the range between imaginary dog positions 1 and 2, a signal is output to the PLC.

1st part system device: X1D07

2nd part system device: X1D27

---Setting range---

-99999.999 to 99999.999 (mm)

【#7573】 PSW8 dog2 Imaginary dog position 2

When the machine enters the range between imaginary dog positions 1 and 2, a signal is output to the PLC.

1st part system device: X1D07

2nd part system device: X1D27

---Setting range---

-99999.999 to 99999.999 (mm)

【#7574】 PSW8 check Selection of area check method

When position switch area checking at high speed is selected, specify the mode of area checking, i.e., whether to use the command type machine position or detector feedback position, for each position switch point.

0: Use the command type machine position as the machine position for position switch area checking.

1: Use the detector feedback position as the machine position for position switch area checking.

(Note) This parameter is valid only when "1" set in "#7500 Pcheck".

【#7581】 PSW9 axis Axis name

Specify the name of the axis for which a position switch is provided.

---Setting range---

X, Y, Z, U, V, W, A, B, or C axis address

【#7582】 PSW9 dog1 Imaginary dog position 1

When the machine enters the range between imaginary dog positions 1 and 2, a signal is output to the PLC.

1st part system device: X1D08

2nd part system device: X1D28

---Setting range---

-99999.999 to 99999.999 (mm)

【#7583】 PSW9 dog2 Imaginary dog position 2

When the machine enters the range between imaginary dog positions 1 and 2, a signal is output to the PLC.

1st part system device: X1D08

2nd part system device: X1D28

---Setting range---

-99999.999 to 99999.999 (mm)

【#7584】 PSW9 check Selection of area check method

When position switch area checking at high speed is selected, specify the mode of area checking, i.e., whether to use the command type machine position or detector feedback position, for each position switch point.

0: Use the command type machine position as the machine position for position switch area checking.

1: Use the detector feedback position as the machine position for position switch area checking.

(Note) This parameter is valid only when "1" set in "#7500 Pcheck".

【#7591】 PSW10 axis Axis name

Specify the name of the axis for which a position switch is provided.

---Setting range---

X, Y, Z, U, V, W, A, B, or C axis address

【#7592】 PSW10 dog1 Imaginary dog position 1

When the machine enters the range between imaginary dog positions 1 and 2, a signal is output to the PLC.

1st part system device: X1D09

2nd part system device: X1D29

---Setting range---

-99999.999 to 99999.999 (mm)

【#7593】 PSW10 dog2 Imaginary dog position 2

When the machine enters the range between imaginary dog positions 1 and 2, a signal is output to the PLC.

1st part system device: X1D09

2nd part system device: X1D29

---Setting range---

-99999.999 to 99999.999 (mm)

【#7594】 PSW10 check Selection of area check method

When position switch area checking at high speed is selected, specify the mode of area checking, i.e., whether to use the command type machine position or detector feedback position, for each position switch point.

0: Use the command type machine position as the machine position for position switch area checking.

1: Use the detector feedback position as the machine position for position switch area checking.

(Note) This parameter is valid only when "1" set in "#7500 Pcheck".

【#7601】 PSW11 axis Axis name

Specify the name of the axis for which a position switch is provided.

---Setting range---

X, Y, Z, U, V, W, A, B, or C axis address

【#7602】 PSW11 dog1 Imaginary dog position 1

When the machine enters the range between imaginary dog positions 1 and 2, a signal is output to the PLC.

1st part system device: X1D0A
2nd part system device: X1D2A

---Setting range---

-99999.999 to 99999.999 (mm)

【#7603】 PSW11 dog2 Imaginary dog position 2

When the machine enters the range between imaginary dog positions 1 and 2, a signal is output to the PLC.

1st part system device: X1D0A
2nd part system device: X1D2A

---Setting range---

-99999.999 to 99999.999 (mm)

【#7604】 PSW11 check Selection of area check method

When position switch area checking at high speed is selected, specify the mode of area checking, i.e., whether to use the command type machine position or detector feedback position, for each position switch point.

0: Use the command type machine position as the machine position for position switch area checking.

1: Use the detector feedback position as the machine position for position switch area checking.

(Note) This parameter is valid only when "1" set in "#7500 Pcheck".

【#7611】 PSW12 axis Axis name

Specify the name of the axis for which a position switch is provided.

---Setting range---

X, Y, Z, U, V, W, A, B, or C axis address

【#7612】 PSW12 dog1 Imaginary dog position 1

When the machine enters the range between imaginary dog positions 1 and 2, a signal is output to the PLC.

1st part system device: X1D0B
2nd part system device: X1D2B

---Setting range---

-99999.999 to 99999.999 (mm)

【#7613】 PSW12 dog2 Imaginary dog position 2

When the machine enters the range between imaginary dog positions 1 and 2, a signal is output to the PLC.

1st part system device: X1D0B
2nd part system device: X1D2B

---Setting range---

-99999.999 to 99999.999 (mm)

【#7614】 PSW12 check Selection of area check method

When position switch area checking at high speed is selected, specify the mode of area checking, i.e., whether to use the command type machine position or detector feedback position, for each position switch point.

0: Use the command type machine position as the machine position for position switch area checking.

1: Use the detector feedback position as the machine position for position switch area checking.

(Note) This parameter is valid only when "1" set in "#7500 Pcheck".

【#7621】 PSW13 axis Axis name

Specify the name of the axis for which a position switch is provided.

---Setting range---

X, Y, Z, U, V, W, A, B, or C axis address

【#7622】 PSW13 dog1 Imaginary dog position 1

When the machine enters the range between imaginary dog positions 1 and 2, a signal is output to the PLC.

1st part system device: X1D0C

2nd part system device: X1D2C

---Setting range---

-99999.999 to 99999.999 (mm)

【#7623】 PSW13 dog2 Imaginary dog position 2

When the machine enters the range between imaginary dog positions 1 and 2, a signal is output to the PLC.

1st part system device: X1D0C

2nd part system device: X1D2C

---Setting range---

-99999.999 to 99999.999 (mm)

【#7624】 PSW13 check Selection of area check method

When position switch area checking at high speed is selected, specify the mode of area checking, i.e., whether to use the command type machine position or detector feedback position, for each position switch point.

0: Use the command type machine position as the machine position for position switch area checking.

1: Use the detector feedback position as the machine position for position switch area checking.

(Note) This parameter is valid only when "1" set in "#7500 Pcheck".

【#7631】 PSW14 axis Axis name

Specify the name of the axis for which a position switch is provided.

---Setting range---

X, Y, Z, U, V, W, A, B, or C axis address

【#7632】 PSW14 dog1 Imaginary dog position 1

When the machine enters the range between imaginary dog positions 1 and 2, a signal is output to the PLC.

1st part system device: X1D0D

2nd part system device: X1D2D

---Setting range---

-99999.999 to 99999.999 (mm)

【#7633】 PSW14 dog2 Imaginary dog position 2

When the machine enters the range between imaginary dog positions 1 and 2, a signal is output to the PLC.

1st part system device: X1D0D

2nd part system device: X1D2D

---Setting range---

-99999.999 to 99999.999 (mm)

【#7634】 PSW14 check Selection of area check method

When position switch area checking at high speed is selected, specify the mode of area checking, i.e., whether to use the command type machine position or detector feedback position, for each position switch point.

0: Use the command type machine position as the machine position for position switch area checking.

1: Use the detector feedback position as the machine position for position switch area checking.

(Note) This parameter is valid only when "1" set in "#7500 Pcheck".

【#7641】 PSW15 axis Axis name

Specify the name of the axis for which a position switch is provided.

---Setting range---

X, Y, Z, U, V, W, A, B, or C axis address

【#7642】 PSW15 dog1 Imaginary dog position 1

When the machine enters the range between imaginary dog positions 1 and 2, a signal is output to the PLC.

1st part system device: X1D0E

2nd part system device: X1D2E

---Setting range---

-99999.999 to 99999.999 (mm)

【#7643】 PSW15 dog2 Imaginary dog position 2

When the machine enters the range between imaginary dog positions 1 and 2, a signal is output to the PLC.

1st part system device: X1D0E

2nd part system device: X1D2E

---Setting range---

-99999.999 to 99999.999 (mm)

【#7644】 PSW15 check Selection of area check method

When position switch area checking at high speed is selected, specify the mode of area checking, i.e., whether to use the command type machine position or detector feedback position, for each position switch point.

0: Use the command type machine position as the machine position for position switch area checking.

1: Use the detector feedback position as the machine position for position switch area checking.

(Note) This parameter is valid only when "1" set in "#7500 Pcheck".

【#7651】 PSW16 axis Axis name

Specify the name of the axis for which a position switch is provided.

---Setting range---

X, Y, Z, U, V, W, A, B, or C axis address

【#7652】 PSW16 dog1 Imaginary dog position 1

When the machine enters the range between imaginary dog positions 1 and 2, a signal is output to the PLC.

1st part system device: X1D0F

2nd part system device: X1D2F

---Setting range---

-99999.999 to 99999.999 (mm)

【#7653】 PSW16 dog2 Imaginary dog position 2

When the machine enters the range between imaginary dog positions 1 and 2, a signal is output to the PLC.

1st part system device: X1D0F

2nd part system device: X1D2F

---Setting range---

-99999.999 to 99999.999 (mm)

【#7654】 PSW16 check Selection of area check method

When position switch area checking at high speed is selected, specify the mode of area checking, i.e., whether to use the command type machine position or detector feedback position, for each position switch point.

0: Use the command type machine position as the machine position for position switch area checking.

1: Use the detector feedback position as the machine position for position switch area checking.

(Note) This parameter is valid only when "1" set in "#7500 Pcheck".

【#7661】 PSW17 axis Axis name

Specify the name of the axis for which a position switch is provided.

---Setting range---

X, Y, Z, U, V, W, A, B, or C axis address

【#7662】 PSW17 dog1 Imaginary dog position 1

When the machine enters the range between imaginary dog positions 1 and 2, a signal is output to the PLC.

1st part system device: X1D10

2nd part system device: X1D30

---Setting range---

-99999.999 to 99999.999 (mm)

【#7663】 PSW17 dog2 Imaginary dog position 2

When the machine enters the range between imaginary dog positions 1 and 2, a signal is output to the PLC.

1st part system device: X1D10

2nd part system device: X1D30

---Setting range---

-99999.999 to 99999.999 (mm)

【#7664】 PSW17 check Selection of area check method

When position switch area checking at high speed is selected, specify the mode of area checking, i.e., whether to use the command type machine position or detector feedback position, for each position switch point.

0: Use the command type machine position as the machine position for position switch area checking.

1: Use the detector feedback position as the machine position for position switch area checking.

(Note) This parameter is valid only when "1" set in "#7500 Pcheck".

【#7671】 PSW18 axis Axis name

Specify the name of the axis for which a position switch is provided.

---Setting range---

X, Y, Z, U, V, W, A, B, or C axis address

【#7672】 PSW18 dog1 Imaginary dog position 1

When the machine enters the range between imaginary dog positions 1 and 2, a signal is output to the PLC.

1st part system device: X1D11

2nd part system device: X1D31

---Setting range---

-99999.999 to 99999.999 (mm)

【#7673】 PSW18 dog2 Imaginary dog position 2

When the machine enters the range between imaginary dog positions 1 and 2, a signal is output to the PLC.

1st part system device: X1D11

2nd part system device: X1D31

---Setting range---

-99999.999 to 99999.999 (mm)

【#7674】 PSW18 check Selection of area check method

When position switch area checking at high speed is selected, specify the mode of area checking, i.e., whether to use the command type machine position or detector feedback position, for each position switch point.

0: Use the command type machine position as the machine position for position switch area checking.

1: Use the detector feedback position as the machine position for position switch area checking.

(Note) This parameter is valid only when "1" set in "#7500 Pcheck".

【#7681】 PSW19 axis Axis name

Specify the name of the axis for which a position switch is provided.

---Setting range---

X, Y, Z, U, V, W, A, B, or C axis address

【#7682】 PSW19 dog1 Imaginary dog position 1

When the machine enters the range between imaginary dog positions 1 and 2, a signal is output to the PLC.

1st part system device: X1D12

2nd part system device: X1D32

---Setting range---

-99999.999 to 99999.999 (mm)

【#7683】 PSW19 dog2 Imaginary dog position 2

When the machine enters the range between imaginary dog positions 1 and 2, a signal is output to the PLC.

1st part system device: X1D12

2nd part system device: X1D32

---Setting range---

-99999.999 to 99999.999 (mm)

【#7684】 PSW19 check Selection of area check method

When position switch area checking at high speed is selected, specify the mode of area checking, i.e., whether to use the command type machine position or detector feedback position, for each position switch point.

0: Use the command type machine position as the machine position for position switch area checking.

1: Use the detector feedback position as the machine position for position switch area checking.

(Note) This parameter is valid only when "1" set in "#7500 Pcheck".

【#7691】 PSW20 axis Axis name

Specify the name of the axis for which a position switch is provided.

---Setting range---

X, Y, Z, U, V, W, A, B, or C axis address

【#7692】 PSW20 dog1 Imaginary dog position 1

When the machine enters the range between imaginary dog positions 1 and 2, a signal is output to the PLC.

1st part system device: X1D13

2nd part system device: X1D33

---Setting range---

-99999.999 to 99999.999 (mm)

【#7693】 PSW20 dog2 Imaginary dog position 2

When the machine enters the range between imaginary dog positions 1 and 2, a signal is output to the PLC.

1st part system device: X1D13

2nd part system device: X1D33

---Setting range---

-99999.999 to 99999.999 (mm)

【#7694】 PSW20 check Selection of area check method

When position switch area checking at high speed is selected, specify the mode of area checking, i.e., whether to use the command type machine position or detector feedback position, for each position switch point.

0: Use the command type machine position as the machine position for position switch area checking.

1: Use the detector feedback position as the machine position for position switch area checking.

(Note) This parameter is valid only when "1" set in "#7500 Pcheck".

【#7701】 PSW21 axis Axis name

Specify the name of the axis for which a position switch is provided.

---Setting range---

X, Y, Z, U, V, W, A, B, or C axis address

【#7702】 PSW21 dog1 Imaginary dog position 1

When the machine enters the range between imaginary dog positions 1 and 2, a signal is output to the PLC.

1st part system device: X1D14

2nd part system device: X1D34

---Setting range---

-99999.999 to 99999.999 (mm)

【#7703】 PSW21 dog2 Imaginary dog position 2

When the machine enters the range between imaginary dog positions 1 and 2, a signal is output to the PLC.

1st part system device: X1D14

2nd part system device: X1D34

---Setting range---

-99999.999 to 99999.999 (mm)

【#7704】 PSW21 check Selection of area check method

When position switch area checking at high speed is selected, specify the mode of area checking, i.e., whether to use the command type machine position or detector feedback position, for each position switch point.

0: Use the command type machine position as the machine position for position switch area checking.

1: Use the detector feedback position as the machine position for position switch area checking.

(Note) This parameter is valid only when "1" set in "#7500 Pcheck".

【#7711】 PSW22 axis Axis name

Specify the name of the axis for which a position switch is provided.

---Setting range---

X, Y, Z, U, V, W, A, B, or C axis address

【#7712】 PSW22 dog1 Imaginary dog position 1

When the machine enters the range between imaginary dog positions 1 and 2, a signal is output to the PLC.

1st part system device: X1D15

2nd part system device: X1D35

---Setting range---

-99999.999 to 99999.999 (mm)

【#7713】 PSW22 dog2 Imaginary dog position 2

When the machine enters the range between imaginary dog positions 1 and 2, a signal is output to the PLC.

1st part system device: X1D15

2nd part system device: X1D35

---Setting range---

-99999.999 to 99999.999 (mm)

【#7714】 PSW22 check Selection of area check method

When position switch area checking at high speed is selected, specify the mode of area checking, i.e., whether to use the command type machine position or detector feedback position, for each position switch point.

0: Use the command type machine position as the machine position for position switch area checking.

1: Use the detector feedback position as the machine position for position switch area checking.

(Note) This parameter is valid only when "1" set in "#7500 Pcheck".

【#7721】 PSW23 axis Axis name

Specify the name of the axis for which a position switch is provided.

---Setting range---

X, Y, Z, U, V, W, A, B, or C axis address

【#7722】 PSW23 dog1 Imaginary dog position 1

When the machine enters the range between imaginary dog positions 1 and 2, a signal is output to the PLC.

1st part system device: X1D16

2nd part system device: X1D36

---Setting range---

-99999.999 to 99999.999 (mm)

【#7723】 PSW23 dog2 Imaginary dog position 2

When the machine enters the range between imaginary dog positions 1 and 2, a signal is output to the PLC.

1st part system device: X1D16

2nd part system device: X1D36

---Setting range---

-99999.999 to 99999.999 (mm)

【#7724】 PSW23 check Selection of area check method

When position switch area checking at high speed is selected, specify the mode of area checking, i.e., whether to use the command type machine position or detector feedback position, for each position switch point.

0: Use the command type machine position as the machine position for position switch area checking.

1: Use the detector feedback position as the machine position for position switch area checking.

(Note) This parameter is valid only when "1" set in "#7500 Pcheck".

【#7731】 PSW24 axis Axis name

Specify the name of the axis for which a position switch is provided.

---Setting range---

X, Y, Z, U, V, W, A, B, or C axis address

【#7732】 PSW24 dog1 Imaginary dog position 1

When the machine enters the range between imaginary dog positions 1 and 2, a signal is output to the PLC.

1st part system device: X1D17

2nd part system device: X1D37

---Setting range---

-99999.999 to 99999.999 (mm)

【#7733】 PSW24 dog2 Imaginary dog position 2

When the machine enters the range between imaginary dog positions 1 and 2, a signal is output to the PLC.

1st part system device: X1D17

2nd part system device: X1D37

---Setting range---

-99999.999 to 99999.999 (mm)

【#7734】 PSW24 check Selection of area check method

When position switch area checking at high speed is selected, specify the mode of area checking, i.e., whether to use the command type machine position or detector feedback position, for each position switch point.

0: Use the command type machine position as the machine position for position switch area checking.

1: Use the detector feedback position as the machine position for position switch area checking.

(Note) This parameter is valid only when "1" set in "#7500 Pcheck".

2.13 Screen Transition Chart

When parameter #1058=0 (MELDAS screen)

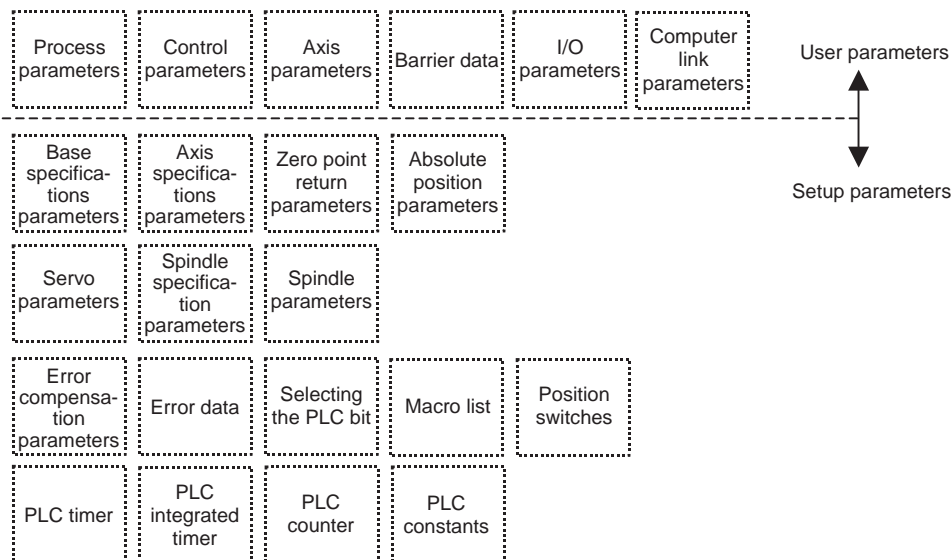

When parameter #1058=1 (MITSUBISHI CNC M700BM HMI screen)

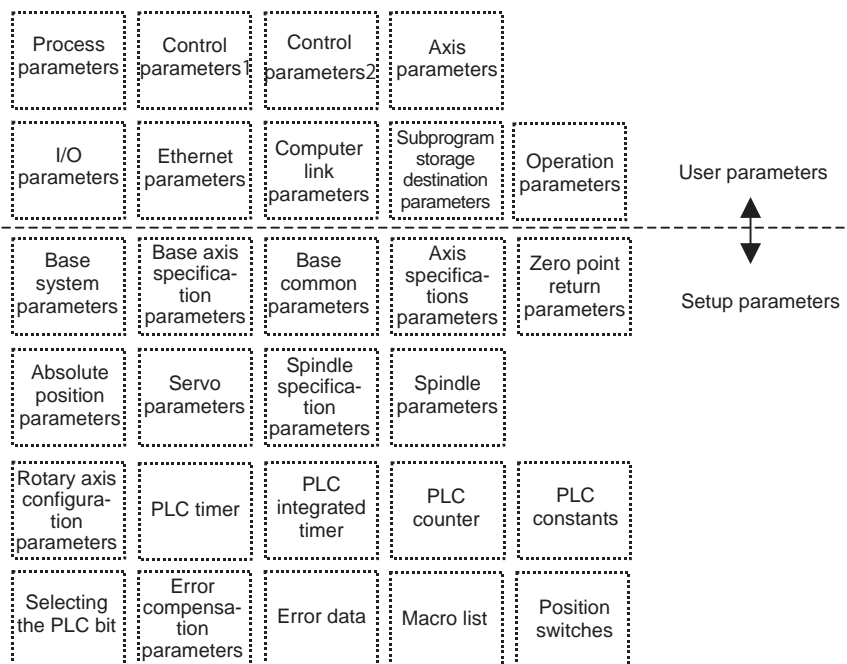

2.14 Unit

(1) Input setting unit and number of decimal digits

The number of digits in the decimal section of the parameters related to length is determined by the input setting unit.

The input setting unit is set with parameter "#1003 iunit".

Input setting unit	No. of digits in decimal section	Example of setting range
B	3	0 - 999.999 (mm)
C	4	0 - 999.9999 (mm)
D	5	0 - 999.99999 (mm)
E	6	0 - 999.999999 (mm)

The setting ranges indicated in this manual use the input setting unit "B".

2.15 Setup Parameters

Pressing the menukey "SET UP" displays the OPEN SETUP PARAM screen.

The system's basic parameters are normally hidden as setup parameters to prevent mistaken operations and to simplify the display.

The setup parameters can be displayed and set by making a declaration to open the setup parameters on this screen.

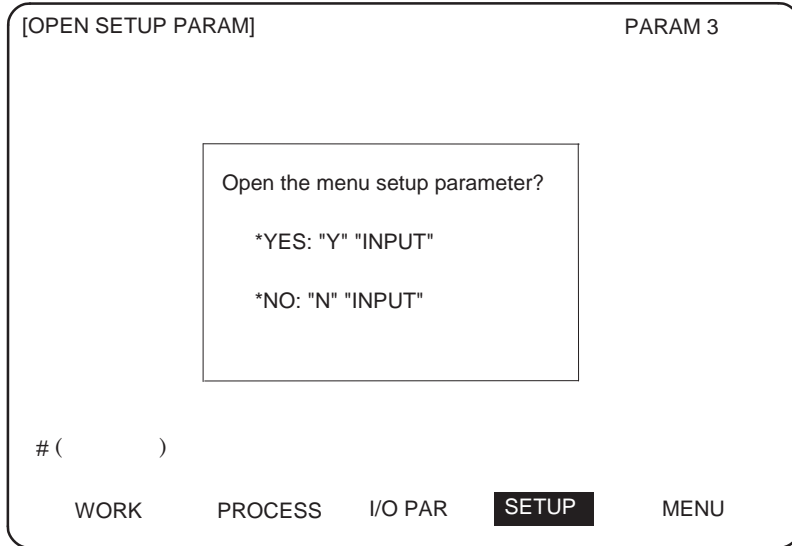

(1) Select the setup parameter.

Key-in "Y" in # (), and then press INPUT.

The basic specification parameter screen appears and the normally hidden setup parameter menu will display.

The required menu can be selected to display and set the setup parameters.

(2) Cancel the setup parameter selection.

Key-in "N" in # (), and then press INPUT.

The setup parameter menu will disappear.

Note: The setup parameters are not displayed when the power is turned ON.

(Note 1) Refer to next section and following for details on the setup parameters.

(Note 2) Be sure to turn OFF the power supply after selecting the setup parameter.

(Note 3) If a key other than the screen changeover key is pressed when the setup parameters are locked, the message "Data Protected" will appear.

2.16 Machine Error Compensation (Function Details)

2.16.1 Function Outline

Machine error compensation includes two independent functions: memorized pitch error compensation and memorized relative position compensation.

(1) Memorized pitch error compensation

According to the specified parameters, this method compensates an axis feed error caused by a ball screw pitch error, etc.

With the reference position defined as the base, set the compensation amount in the division points obtained by equally dividing the machine coordinates. (See Fig. 1. 1)

The compensation amount can be set by either the absolute or incremental system.

Select the desired method with the #4000:Pinc. Machine position is compensated between division points n and $n+1$ as much as compensation amount between them by linear approximation.

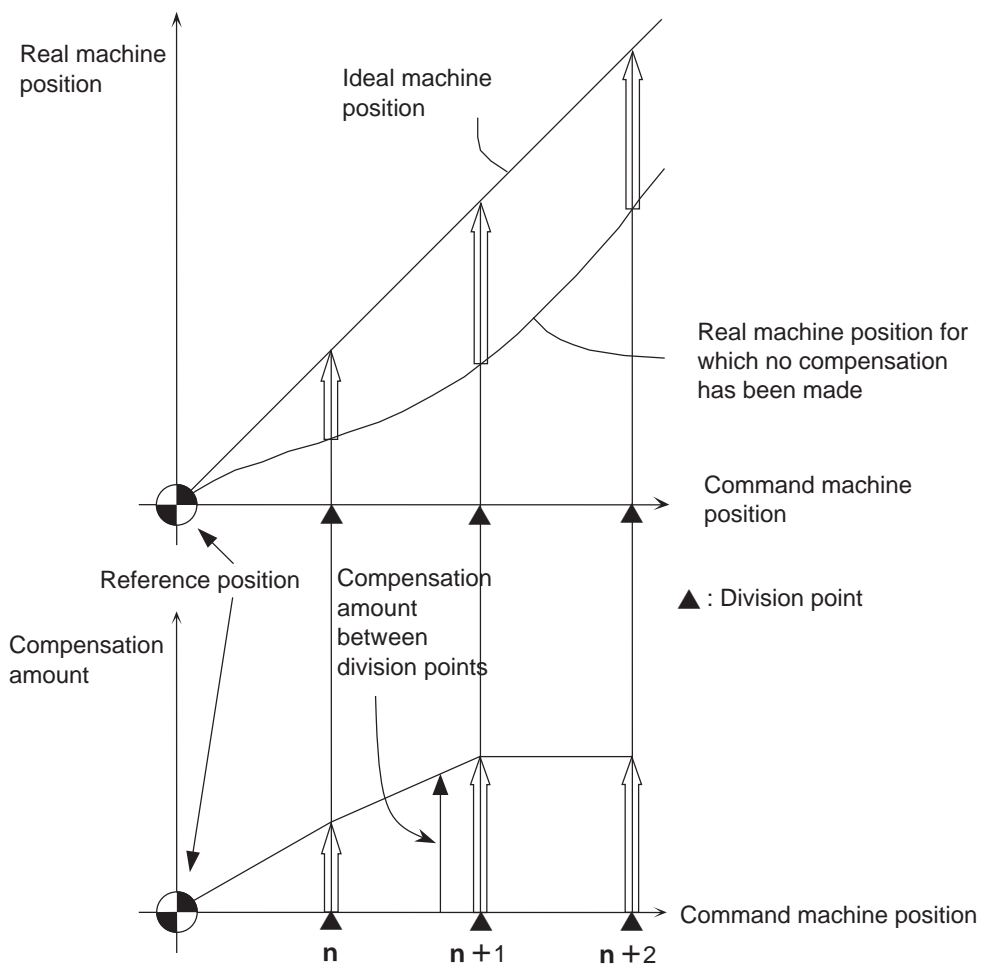

Fig. 1.1 Relationship between the compensation amount and machine position

(2) Memorized relative position compensation

This method, according to the parameters specified in advance, compensates the relative position error between two orthogonal axes caused by deflection of the moving stand.

For this, as shown in Fig. 1. 2, specify the compensation amount in the compensation axis direction in the division points obtained by equally dividing the machine coordinates of the base axis.

The base axis is one of the two orthogonal axes to which relative position compensation applies. This axis is used as the criterion for relative-error measurement. The compensation axis is the coordinate axis that is orthogonal to the base axis. The compensation is actually made for this coordinate axis.

The section between division points n and $n+1$ is compensated smoothly by linear approximation.

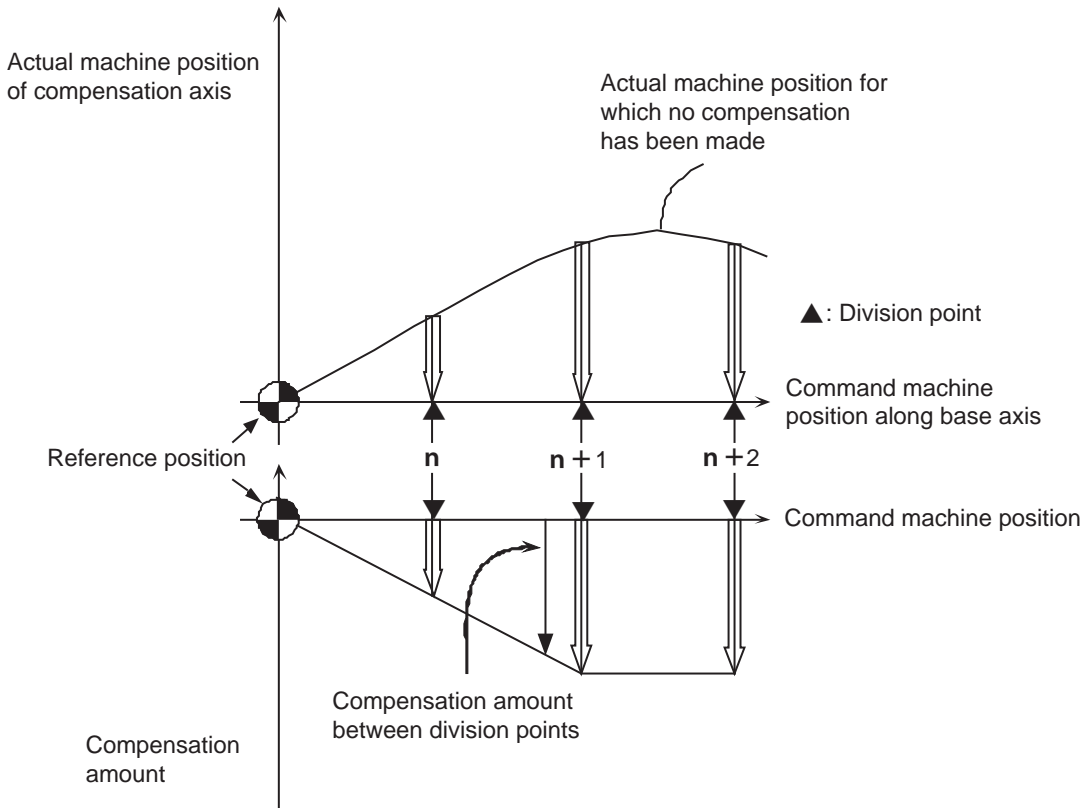

Fig. 1.3 Relationship between the compensation amount and machine position

2.16.2 Setting Compensation Data

Compensation data can be set according to either absolute or incremental system.

"#4000:Pinc" 0: Absolute system

1: Incremental system

(1) Absolute system

Feed from the reference position to each division point is executed as shown in Fig. 2.1. The following is obtained at this time. Set it as the compensation amount.

$$(\text{Specified position} - \text{Real machine position}) \times 2 \text{ (Unit of output)}$$

For example, assume that the feed from the reference position to the +100mm position is executed.

Also, assume that the real machine position is 99.990mm. In this case, the following value is defined as the compensation amount used at the +100mm position:

$$(100000 - 99990) \times 2 = 20 \text{ pulses}$$

The resultant value is defined as the compensation amount. Assume that the real machine position

resulting when feed to the -100mm position is executed, is -99.990mm. In this case, the following value is defined as the compensation amount used at the -100mm position:

$$(-100000 - (-99990)) \times 2 = -20 \text{ pulses}$$

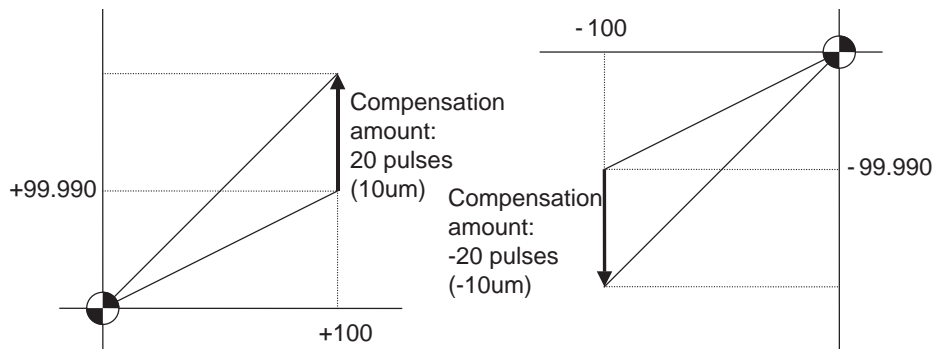

Fig. 2.1

(2) Incremental system

Fig. 2.2 contains a machine position that is placed in the positive direction with respect to the reference position.

Assume that feed from division n-1 to n (division interval) is executed. In this case, the following value is defined as the compensation amount:

$$(\text{Division interval} - \text{Actual movement distance}) \times 2 \text{ (Unit of output)}$$

(3) Fig. 2.3 contains a machine position that is placed in the negative direction with respect to the reference position. Assume that feed from division point n+1 to n by the division interval is executed. In this case, the following value is defined as the compensation amount:

$$(\text{Division interval} + \text{Actual movement distance}) \times 2 \text{ (Unit of output)}$$

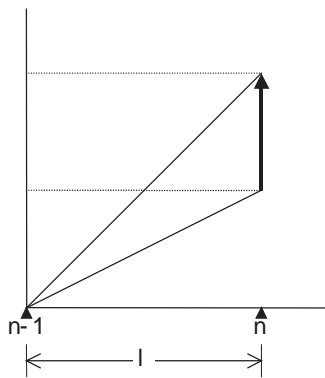

Fig. 2.2

Unit : Unit of output
Range : -128 to 127

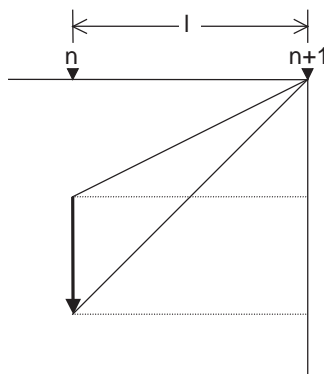

Fig. 2.3

n: Division point compensation number
l: Division interval

(Note) The unit of output is used as the unit of setting.
The actual unit of compensation pulses depends on the compensation

(Note) The unit of output is used as the unit of setting. The actual unit of compensation pulses depends on the compensation scale factor.

2.16.3 Example in Using a Linear Axis as the Base Axis

(1) When "mdvno" or "pdvno" exists at both ends of "rdvno":

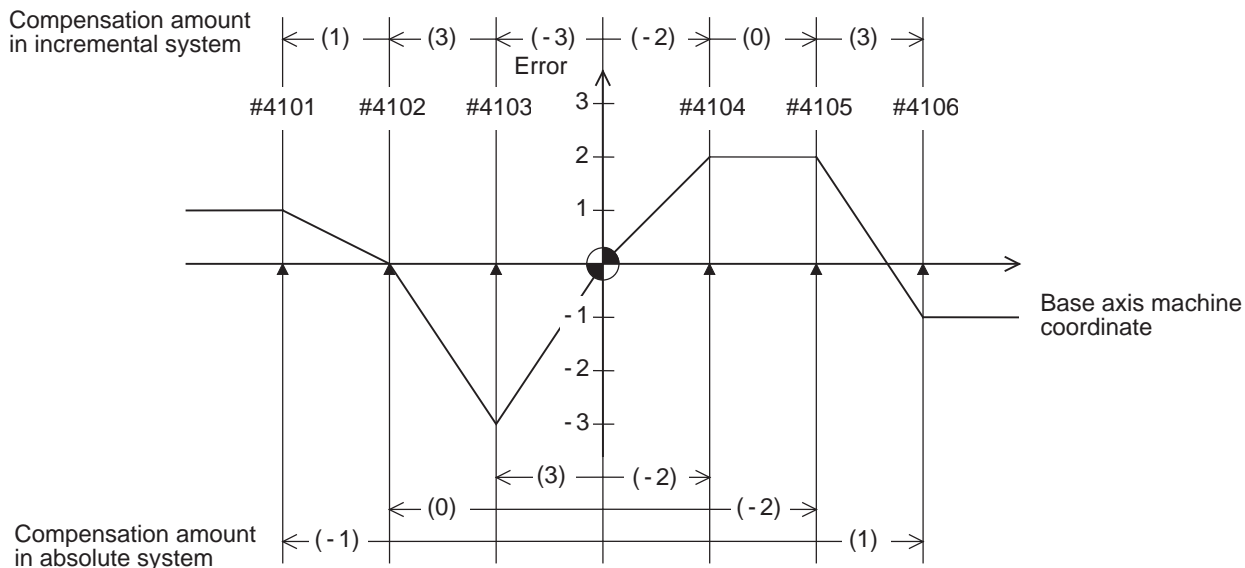

Division point number	#4101	#4102	#4103	#4104	#4105	#4106	
Specified machine position	-300.000	-200.000	-100.000	100.000	200.000	300.000	
Real machine position	-299.999	-200.000	-100.003	100.002	200.002	299.999	
Compensation amount	Incremental	2	6	-6	-4	0	6
	Absolute	-2	0	6	-4	-4	2

rdvno	4103
mdvno	4101
pdvno	4106

If the setting range ("mdvno" to "pdvno") is exceeded, the compensation will be based on compensation amount at "mdvno" or "pdvno".

(2) When the range compensated is only the positive range:

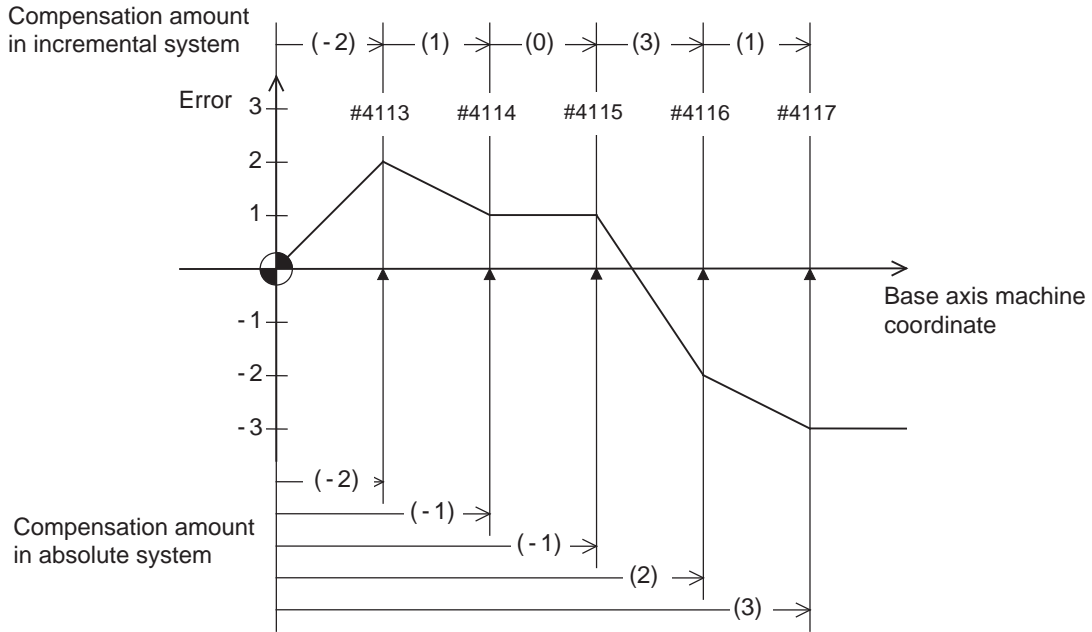

Division point number	#4113	#4114	#4115	#4116	#4117
Incremental	-4	2	0	6	2
Absolute	-4	-2	-2	4	6

rdvno	4112
mdvno	4113
pdvno	4117

If the machine position exceeds "pdvno", the compensation will be based on the compensation amount at "pdvno". If the machine position is negative in this case, no compensation will be executed.

(3) When the range compensated is only the negative range:

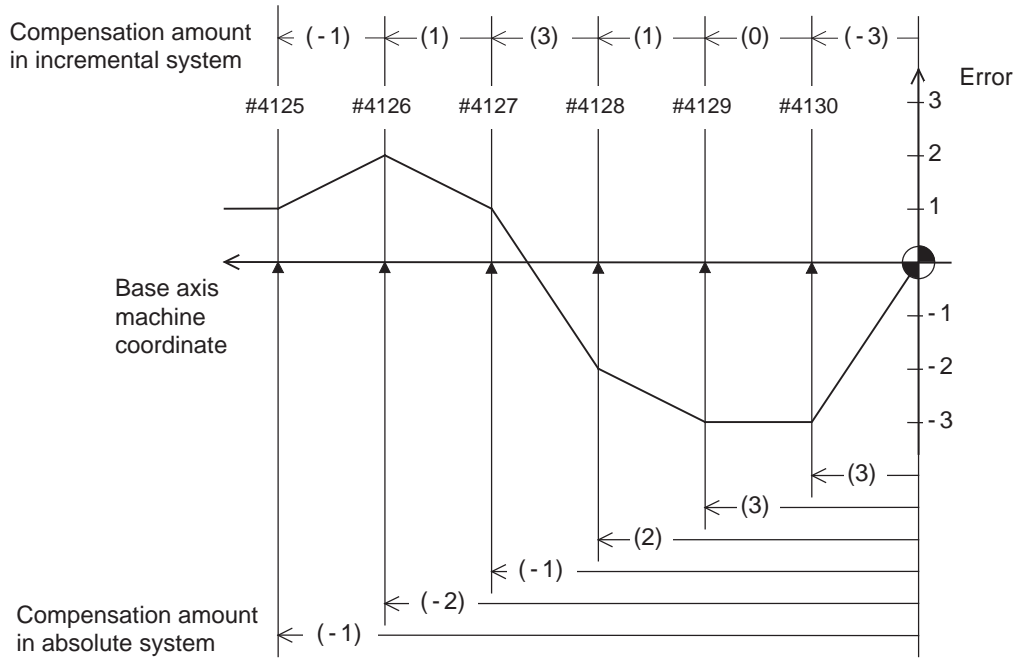

Division point number	#4125	#4126	#4127	#4128	#4129	#4130
Incremental	-2	2	6	2	0	-6
Absolute	-2	-4	-2	4	6	6

rdvno	4130
mdvno	4125
pdvno	4130

If the machine position exceeds "mdvno", the compensation will be based on compensation amount at "mdvno".

(4) When compensation is executed in a range that contains no reference position:

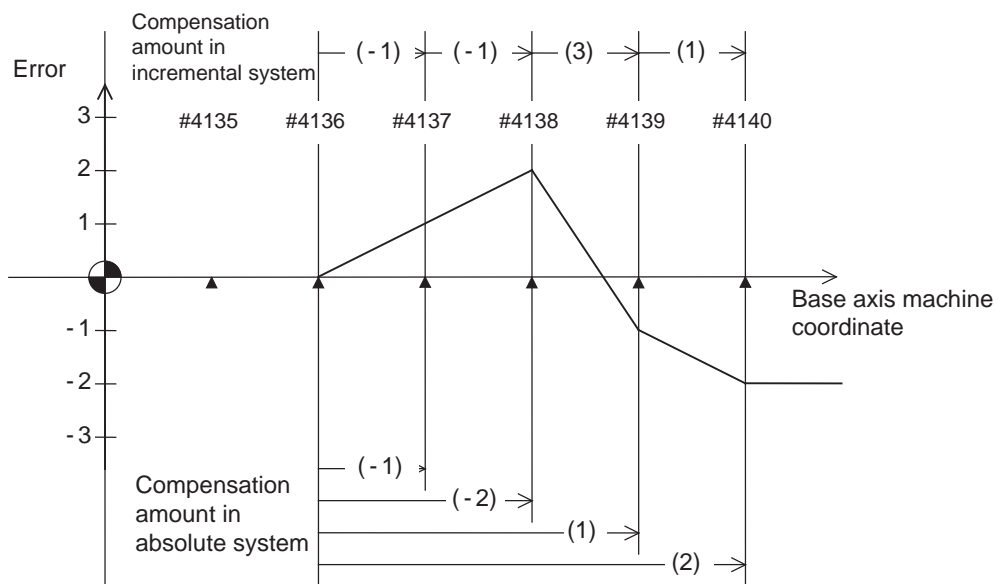

Division point number	#4135	#4136	#4137	#4138	#4139	#4140	rdvno	4134	
Compensation amount	Incremental			-2	-2	6	2	mdvno	4136
	Absolute			-2	-4	2	4	pdvno	4140

In this case, the compensation is executed in the range from "mdvno" to "pdvno". This setting rule applies also when the compensation is executed in a range which contains negative machine positions and no reference position.

2.16.4 Example in Using a Rotary Axis as the Base Axis

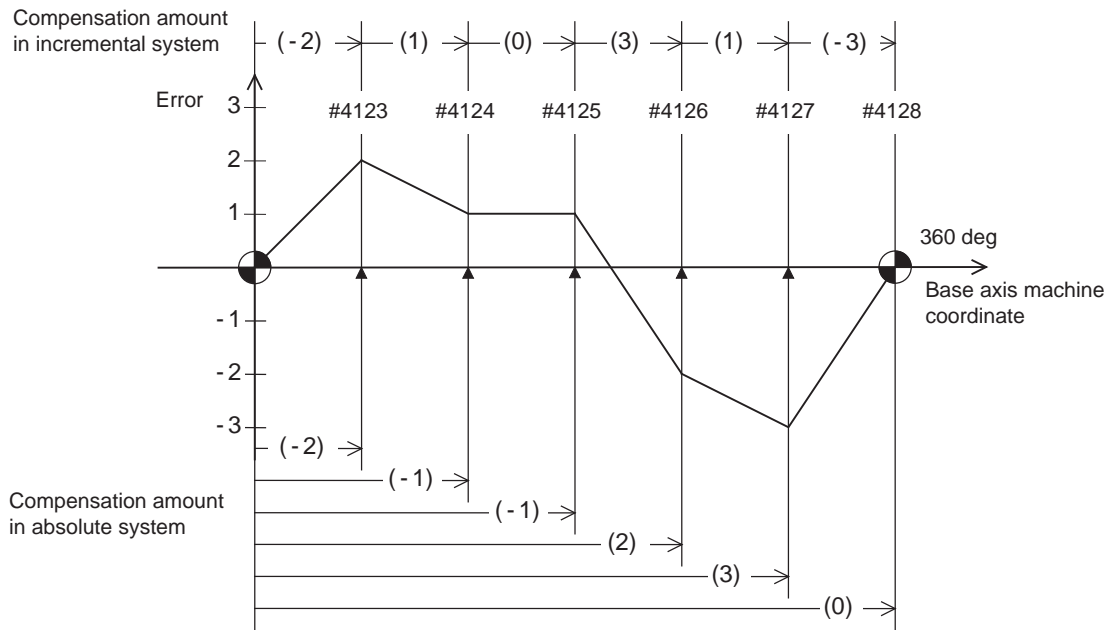

Division point number	#4123	#4124	#4125	#4126	#4127	#4128	rdvno	4122
Compensation amount	Incremental	-4	2	0	6	2	mdvno	4123
	Absolute	-4	-2	-2	4	6	pdvno	4128

In this case, the sum of the compensation amounts set according to the incremental system is always "0". For the absolute system, the compensation amount at the terminal point (360 degrees) is always "0".

2.17 Position Switch (Function Details)

2.17.1 Function Outline

Position switches (PSW) are used as alternatives for the dog switches provided on the machine axis. Imaginary dog switches, with axis names and imaginary dog coordinates preset by parameters, output a signal to the PLC interface when the machine reaches the switch area. The imaginary dog switches are called position switches (PSW).

Position switch Nos. of PSW1 to PSW24 and signal devices

	<axis>	<dog1>	<dog2>	<check>	Part system 1 device	Part system 2 device
PSW1	#7501	#7502	#7503	#7504	X1D00	X1D20
PSW2	#7511	#7512	#7513	#7514	X1D01	X1D21
PSW3	#7521	#7522	#7523	#7524	X1D02	X1D22
PSW4	#7531	#7532	#7533	#7534	X1D03	X1D23
:	:	:	:	:	:	:
PSW24	#7731	#7732	#7733	#7734	X1D17	X1D37

Position switches (PSW1 - PSW24) are used to set imaginary dog coordinates (dog1 and dog2) on the coordinate axes, whose names are preset with <axis>, as alternatives for the dog switches provided on the machine axis.

When the machine reaches the switch area, a signal is output to the corresponding device of the PLC interface.

Position switch area checking can be performed at high-speed by parameter setting.

In high-speed checking, the parameter determines which is used between the command type machine position or detector feedback position for area checking by each position switch.

For description of the parameter, refer to "2.12 Position Switches".

Example of settings of dog1 and dog2 and operation

Setting of dog1 and dog2	dog1, dog2 position	Operation	
dog1 < dog2		A signal is output between dog1 and dog2.	
dog1 > dog2		A signal is output between dog1 and dog2.	
dog1 = dog2		If dog1 equals dog2, the dog1 position triggers a signal.	

Rotary axis

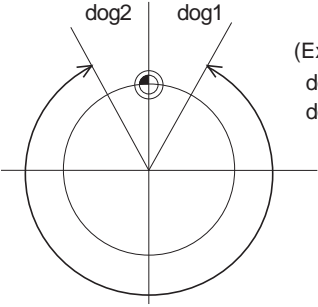
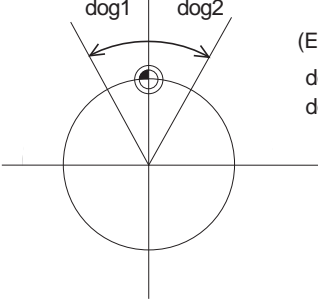
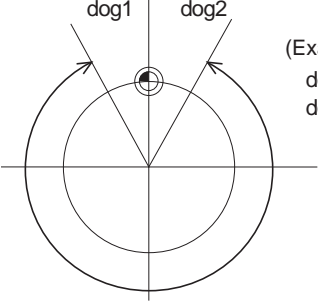
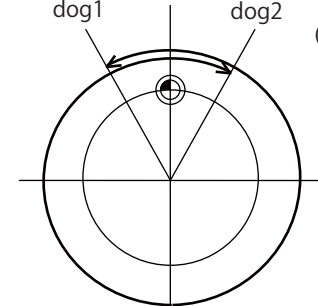
Setting of dog1 and dog2	dog1, dog2 position	Description
dog1 < dog2	 <p>(Example) dog1 = 30.000 dog2 = 330.000</p>	A signal is output between dog1 and dog2.
	 <p>(Example) dog1 = -30.000 dog2 = 30.000</p>	A signal is also output when dog1 is negative.
dog1 > dog2	 <p>(Example) dog1 = 330.000 dog2 = 30.000</p>	A signal is output between dog2 and dog1.
dog1 ≤ 0 and 360 ≤ dog2	 <p>(Example) dog1 = -30.000 dog2 = 390.000</p>	When the range of dog1 and dog2 include 0 to 360 degrees, a signal is output whenever and wherever the machine reaches.

2.17.2 Canceling the Position Switch

To cancel the position switch, enter the number (#751) of the position switch to be canceled in # () of the setting field, enter a slash "/" in DATA (), then press the INPUT key. This deletes the axis name for the specified position switch, thus invalidating the position switch.

The data specified for <dog1> and <dog2> are still stored in memory. To validate the position switch again, therefore, it is enough to specify the axis name only.

2.18 Table: "Contents of bit selection parameters #6449 to #6496"

	Symbol name	7	6	5	4	3	2	1	0	
0	#6449 R7824 L	Control unit temperature alarm ON	-	-		Counter C retention	Integrating timer T retention	PLC counter program ON	PLC timer program ON	
1	#6450 R7824 H		External alarm message display	Alarm/operator change	Full screen display of message	-	Operator message ON	1 R type	0 F type	Alarm message ON
2	#6451 R7825 L	-	-	GX Developer communication ON	PLC development environment selection		Onboard editing not possible	-	Onboard ON	
3	#6452 R7825 H	-	-	-	-	-	-	Extended PLC instruction mode valid	-	
4	#6453 R7826 L	PLC integrated timer Number of variable integrated timer points setting			-	-				
5	#6454 R7826 H	PLC counter number of variable counter points setting				PLC timer number of variable timer points setting				
6	#6455 R7827 L	-	-	RS232-C I/F Modbus RTU connection ON	Battery alarm signal output change	-	-	-	-	
7	#6456 R7827 H	Illegal PLC alarm display contents change	Output device compulsorily OFF	-	-	-	-	-	-	
8	#6457 R7828 L	High-speed input specification 1								
9	#6458 R7828 H									
A	#6459 R7829 L	High-speed input specification 2								
B	#6460 R7829 H									
C	#6461 R7830 L	High-speed output specification 1								
D	#6462 R7830 H									
E	#6463 R7831 L	High-speed output specification 2								
F	#6464 R7831 H									

	Symbol name	7	6	5	4	3	2	1	0
0	#6465 R7832 L	High-speed input specification 3							
1	#6466 R7832 H								
2	#6467 R7833 L	High-speed input specification 4							
3	#6468 R7833 H								
4	#6469 R7834 L	High-speed input specification 5							
5	#6470 R7834 H								
6	#6471 R7835 L	High-speed input specification 6							
7	#6472 R7835 H								
8	#6473 R7836 L	High-speed output specification 3							
9	#6474 R7836 H								
A	#6475 R7837 L	High-speed output specification 4							
B	#6476 R7837 H								
C	#6477 R7838 L	High-speed output specification 5							
D	#6478 R7838 H								
E	#6479 R7839 L	High-speed output specification 6							
F	#6480 R7839 H								

(Note 1) Be sure to set the bits indicated - and blanks to 0.

(Note 2) Parameters #6481 to #6496 are reserved for debugging by Mitsubishi.



Appendix

3.1 7-segment LED Alarm/Status Display Function

With the 7-segment LED mounted on the operation board I/O, NC status is displayed.
When alarm occurs, the most crucial alarm is displayed per part system.

3.1.1 Display of Status

The 7-segment display at the normal state is “—” flickering.

3.1.2 Display of Alarm

When an alarm occurs, the alarm occurrence itself is reported at the first stage, and then at the next stage, its details are displayed.

First, “A.L” flickers 3 times. If it is a stop code, “S.T” flickers.

Then, details of the alarm are displayed in 3 separate phases.

[Transition of 7-segment LED display]

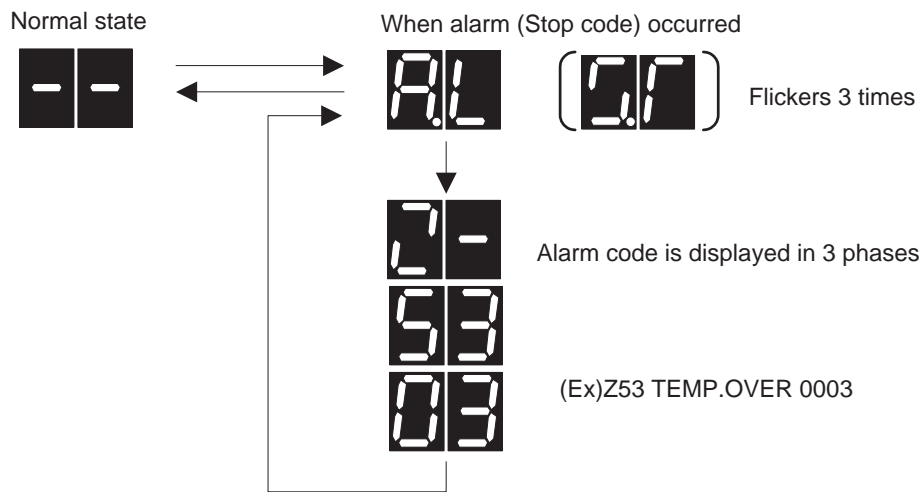

[Example of alarm displays for 2-part system]

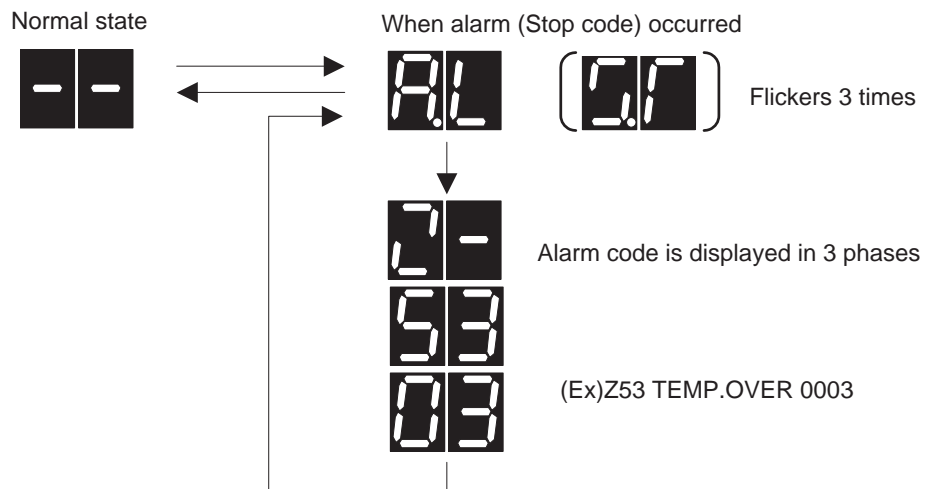

3.1.3 Precautions

LED display status remains normal when any of the following alarms should occur.

- (1) Emergency stop EXIN
- (2) Emergency stop WAIT
- (3) M01 Operation error 0110 Cutting block start interlock
- (4) M01 Operation error 0120 Cutting block start interlock

(Supplement) Examples of alarm displays are provided in the following sections.

3.1.4 Example of Alarm Display

[OPERATION ERROR]

Alarm/warning code						7-segment LED display (Transition)							
						1L 1R		2L 2R		3L 3R			
M01 OPERATION ERROR 0006 XYZ													
1L	1R	2L	2R	3L	3R	OPERATION ERROR		Error No. (last 3 digits)			Axis bit		
M01 OPERATION ERROR 0101													
1L	1R	2L	2R	3L	3R	OPERATION ERROR		Error No. (last 3 digits)			Blank		
M01 AUX OPER. ALM 0025 0004													
1L	1R	2L	2R	3L	3R	AUX OPER. ALM		Error No. (last 3 digits)			Axis bit		
M01 AUX OPER. ALM 0006 0002													
1L	1R	2L	2R	3L	3R	AUX OPER. ALM		Error No. (last 3 digits)			Axis bit		
M90 PARAM SET MODE													
1L	1R	2L	2R	3L	3R	PARAM SET MODE			Blank				

(Note 1) As for the spindle, error axis bit is not displayed.

(Note 2) The contents of the error display for "M01 OPERATION ERROR", "M00 AUX OPER. ALM" and "M01 AUX OPER. ALM", are the same.

(Note 3) The contents of the error display for "0001 to 0099", "1000 to 1099", "0100 to 0199" and "1100 to 1199" of "M01 OPERATION ERROR", are the same.

[STOP CODE]

Alarm/warning code						7-segment LED display (Transition)					
						1L 1R		2L 2R		3L 3R	
T01 CAN'T CYCLE ST 0105											
1L	1R	2L	2R	3L	3R						
Stop code		Error No. (last 2 digits)		Blank							
T02 FEED HOLD 0202											
1L	1R	2L	2R	3L	3R						
Stop code		Error No. (last 2 digits)		Blank							
T03 BLOCK STOP 0301											
1L	1R	2L	2R	3L	3R						
Stop code		Error No. (last 2 digits)		Blank							
T04 COLLATION STOP 0401											
1L	1R	2L	2R	3L	3R						
Stop code		Error No. (last 2 digits)		Blank							
T10 FIN WAIT 0001											
1L	1R	2L	2R	3L	3R						
Stop code		Error No. (last 2 digits)		Blank							

(Note 1) The factors of "In dwell execution" or "unclamp signal wait" under "T10 FIN WAIT" are not displayed in the error display area.

[EMERGENCY STOP]

Alarm/warning code						7-segment LED display (Transition)					
						1L 1R		2L 2R		3L 3R	
EMG Emergency stop STOP											
1L	1R	2L	2R	3L	3R						
Emergency stop		R69 (first 2 digits)		R69 (last 2 digits)							

[PROGRAM ERROR]

Alarm/warning code						7-segment LED display (Transition)					
						1L 1R		2L 2R		3L 3R	
P273 MACRO OVERCALL											
1L	1R	2L	2R	3L	3R						
Program error		Error No.		Blank							

[SYSTEM ALARM]

Alarm/warning code						7-segment LED display (Transition)					
						1L 1R		2L 2R		3L 3R	
Z70 ABS. ILLEGAL 0001 X											
1L		1R		2L		2R		3L		3R	
ABS. ILLEGAL		Error No.				Axis bit					
Z71 DETECTOR ERROR 0002 X											
1L		1R		2L		2R		3L		3R	
DETECTOR ERROR		Error No.				Axis bit					
Z72 COMPARE ERROR 0001 Z											
1L		1R		2L		2R		3L		3R	
COMPARE ERROR		Error No.				Axis bit					
Z73 ABS. WARNING 0003 XYZ											
1L		1R		2L		2R		3L		3R	
ABS. WARNING		Error No.				Axis bit					
Z70 AUX POS. ERR 0001 0001											
1L		1R		2L		2R		3L		3R	
AUX POS. ERR		Error No.				Axis bit					
Z71 AUX DETEC. ERR 0001 0001											
1L		1R		2L		2R		3L		3R	
AUX DETEC. ERR		Error No.				Axis bit					
Z73 AUX SYSTEM WRN 0001 0001											
1L		1R		2L		2R		3L		3R	
AUX SYSTEM WRN		Error No.				Axis bit					
Z40 FORMAT NOT MET											
1L		1R		2L		2R		3L		3R	
FORMAT NOT MET		Blank									

(Note 1) The contents of error display for "0001" and "0101" of "Z70 ABS. ILLEGAL" are the same.

[MCP ALARM]

Alarm/warning code						7-segment LED display (Transition)					
						1L 1R		2L 2R		3L 3R	
Y02 SYSTEM ALARM 0051 0004											
1L	1R	2L	2R	3L	3R						
SYSTEM ALARM		Error No. (last 2 digits)		Error code							
Y03 AMP. UNEQUIPPED XYZS											
1L	1R	2L	2R	3L	3R						
AMP. UNEQUIPPED		Axis bit		Blank							
Y05 INIT PARAM ERR 1039											
1L	1R	2L	2R	3L	3R						
INIT PARAM ERR		Parameter No. (last 2 digits)		Blank							
Y06 mcp_no ERROR											
1L	1R	2L	2R	3L	3R						
mcp_no ERROR		Blank		Blank							
Y02 AUX SYSTEM ALM 0051 0004											
1L	1R	2L	2R	3L	3R						
mcp_no ERROR		Blank		Blank							
Y03 AUX AMP UNEQU. 0001											
1L	1R	2L	2R	3L	3R						
mcp_no ERROR		Blank		Blank							

(Note 1) As for the spindle, error axis bit is not displayed.

(Note 2) Axis No. of "Data ID error" and "Recv fram No." under "Y02 SYSTEM ALARM 0051" or "Y02 AUX SYSTEM ALM 0051" are not displayed in the error display area.

[MCP WARNING]

Alarm/warning code						7-segment LED display (Transition)					
						1L 1R		2L 2R		3L 3R	
Y51 Parameter error 0012 Z											
1L	1R	2L	2R	3L	3R						
Parameter error		Error No. (last 2 digits)		Axis bit							
Y90 SP. NON SIGNAL 0003											
1L	1R	2L	2R	3L	3R						
SP. NON SIGNAL		Open-phase bit		Blank							

(Note 1) As for the spindle, error axis bit is not displayed.

[SERVO ALARM]

Alarm/warning code						7-segment LED display (Transition)					
						1L 1R		2L 2R		3L 3R	
S01 SERVO ALARM: PR 0031 X											
1L	1R	2L	2R	3L	3R						
SERVO ALARM:PR		Error No. (last 2 digits)		Axis bit							
S02 Initial parameter error 3225 S											
1L	1R	2L	2R	3L	3R						
Initial parameter error		Error No. (last 2 digits)		Axis bit							
S03 SERVO ALARM: NR 0052 Y											
1L	1R	2L	2R	3L	3R						
SERVO ALARM:NR		Error No. (last 2 digits)		Axis bit							
S04 SERVO ALARM: AR 006F Y											
1L	1R	2L	2R	3L	3R						
SERVO ALARM:AR		Error No. (last 2 digits)		Axis bit							
S01 AUX SERVO ALM 0016 0004											
1L	1R	2L	2R	3L	3R						
AUX SERVO ALM		Error No. (last 2 digits)		Axis bit							
S02 AUX SERVO ALM 0020 0001											
1L	1R	2L	2R	3L	3R						
AUX SERVO ALM		Error No. (last 2 digits)		Axis bit							
S03 AUX SERVO ALM 0031 0002											
1L	1R	2L	2R	3L	3R						
SERVO ALARM:NR		Error No. (last 2 digits)		Axis bit							

(Note 1) As for the spindle, error axis bit is not displayed.

[SERVO WARNING]

Alarm/warning code						7-segment LED display (Transition)					
						1L 1R		2L 2R		3L 3R	
S51 PARAMETER ERROR 2205 Z											
1L	1R	2L	2R	3L	3R						
Parameter error		Error No. (last 2 digits)		Axis bit							
S52 SERVO WARNING E0 X											
1L	1R	2L	2R	3L	3R						
SERVO WARNING		Error No.		Axis bit							
S52 AUX SERVO WRN 0092 0001											
1L	1R	2L	2R	3L	3R						
SERVO WARNIN		Error No.		Axis bit							

(Note 1) As for the spindle, error axis bit is not displayed.

(Note 2) Only the last 2 digits are displayed for "S51 PARAMETER ERROR" parameter No.

(Note 3) The contents of the display for "S52 SERVO WARNING" and "S52 AUX SERVO WRN" are the same.

Revision History

Date of revision	Manual No.	Revision details
Sept. 2008	IB(NA)1500908-A	First edition created.
Mar. 2009	IB(NA)1500908-B	<ul style="list-style-type: none"> - Alarms and parameters are revised as the optimum acceleration/deceleration function is enhanced. - Alarms and parameters are revised as the safety observation function is enhanced. - Mistakes are corrected.
Dec. 2009	IB(NA)-1500908-C	<ul style="list-style-type: none"> - Corrected the items below. <li style="padding-left: 20px;">#1284 ext20 bit0: ext20 bit0: Spindle speed clamp check <li style="padding-left: 20px;">P134 G96 Clamp Err. <li style="padding-left: 20px;">M01 1043 No spindle speed clamp - Corrected the mistakes.
Jul. 2010	IB(NA)-1500908-D	<ul style="list-style-type: none"> - Added the items below. <li style="padding-left: 20px;">#1253(PR) set25 bit0: The number of definition files of the machine tool builder macro programs changeover <li style="padding-left: 20px;">#1253(PR) set25 bit1: Inch/metric changeover disabled <li style="padding-left: 20px;">#1258(PR) set30 bit0: Skip I/F switch <li style="padding-left: 20px;">#1260(PR) set32 bit7: Select how to store coordinates during servo OFF of spindle C axis <li style="padding-left: 20px;">#1268(PR) ext04 bit6: Tool length compensation operation selection (for M system only) <li style="padding-left: 20px;">#1318(PR) MacVcom Machine tool builder macro variable for each part system <li style="padding-left: 20px;">#1565 helgear Helical machining base axis <li style="padding-left: 20px;">#1595 hobm Hobbing rotary tool spindle No. <li style="padding-left: 20px;">#1596 hobs Hobbing workpiece axis No. <li style="padding-left: 20px;">#2155 hob_fwd_g Feed forward gain for hobbing machining <li style="padding-left: 20px;">#8062 ThreadPullUp <li style="padding-left: 20px;">#8063 PullUpSpeed <li style="padding-left: 20px;">#11033(PR) skipB_no_sens Unconnected sensor selection when skip is set to contact B - Corrected the items below. <li style="padding-left: 20px;">#8213(PR) Rotation axis type <li style="padding-left: 20px;">#1089 Cut_RT Short cut for rotary axis <li style="padding-left: 20px;">#1090 Lin_RT Linear rotary axis <li style="padding-left: 20px;">#3031 smcp_no Drive unit I/F channel No. (spindle) - Corrected the mistakes.
Oct. 2010	IB(NA)-1500908-E	<ul style="list-style-type: none"> - This manual supports M750BM. - Added the chapters below. <li style="padding-left: 20px;">2.7 Rotary Axis Configuration Parameters <li style="padding-left: 20px;">2.11 PLC Axis Indexing Parameters - Changed the chapter No. below. <li style="padding-left: 20px;">2.8 Machine Error Compensation Parameters (2.7 in the previous version) - Corrected the chapters below. <li style="padding-left: 20px;">2.13 Screen Transition Chart <li style="padding-left: 20px;">2.14 Unit - Added the alarms below. <li style="padding-left: 20px;">1.1 Operation Errors <li style="padding-left: 40px;">M01_0033, M01_0065, M01_0066, M01_0070, M01_0185, M01_0230, M01_0231, M01_0232, M01_0250, M01_1003, M01_1004 <li style="padding-left: 20px;">1.2 Stop Codes <li style="padding-left: 40px;">T01_0117, T11_0010 <li style="padding-left: 20px;">1.4 MCP Alarms <li style="padding-left: 40px;">Y20_0020, Y20_0027, Y20_0031 <li style="padding-left: 20px;">1.6 Absolute Position Detection System Alarms <li style="padding-left: 40px;">Z70_0007 <li style="padding-left: 20px;">1.8 Emergency Stop Alarms <li style="padding-left: 40px;">EMG_LINE <li style="padding-left: 20px;">1.12 Program Errors <li style="padding-left: 40px;">P161, P162, P163, P544, P545, P546, P547, P950, P951, P952, P953, P954, P955 - Corrected the items below. <li style="padding-left: 20px;">1.5 System Alarms <li style="padding-left: 40px;">Z53 <li style="padding-left: 20px;">1.12 Program Errors <li style="padding-left: 40px;">P111, P126, P152, P520 (Continue to the next page)

Date of revision	Manual No.	Revision details
		<p>(Continued from the previous page)</p> <ul style="list-style-type: none"> - Added the parameters below. 2.1 Machining Parameters <ul style="list-style-type: none"> #8043 to #8044, #8116 to #8117, #8122 to #8125, #8145, #8155 to #8160, #8173, #8215 to #8216, #8621 to #8627, #8707 to #8708, #8711 to #8712 #8880 to #8889, #8901 to #8906, #8915 to #8919, #8940, #19001 to #19002 #19004 to #19005, #19425 to #19428 2.2 I/O Parameters <ul style="list-style-type: none"> #9017 to #9018, #9120, #9220, #9320, #9420, #9520, #9701, #9706, #9711 to #9721, #9731 to #9741, #9751 to #9761, #9771 to #9781 2.3 Base Specifications Parameters <ul style="list-style-type: none"> #1281 ext17 bit0, #1058, #1163, #1219 aux03 bit7, #1234 set06 bit3, #1238 set10 bit6, #1240 set12 bit4 to #1251 set23, #1254 set26 to #1259 set31, #1261 set33 to #1264 set36, #1268 ext04 bit2, #1281 ext17 bit3, bit6, bit7, #1282 ext18 bit1, #1326, #1328, #1333, #1335, #1338 to #1340(PR), #1342, #1361, #1365 to #1366, #1493, #1566, #11011 to #11012, #11017, #11019, #11022, #11028 to #11030, #11034, #11036, #12001 to #12004, #1367, #1299(PR) ext35 bit0 2.4 Axis Specifications Parameters <ul style="list-style-type: none"> #2082, #2034(PR) to #2036, #2106, #2109 to #2115, #2139, #2141 to #2144, #2146 to #2149, #2151 to #2153, #2169 to #2174, #2177, #2180(PR), #2585 to #2588 2.6 Spindle Parameters <ul style="list-style-type: none"> #3120, #3137 to #3138, #3140(PR) 2.8 Machine Error Compensation Parameters <ul style="list-style-type: none"> #4001+10(n-1) to #4005+10(n-1), #4101 - 5124, #4008+10(n-1) to #4009+10(n-1), #18151-18900 - Corrected the items below. <ul style="list-style-type: none"> #1281 ext17 bit0, #2082 - Added explanation to the items below. <ul style="list-style-type: none"> #4001+10(n-1) to #4005+10(n-1), #4101 - 5124 - Deleted the items below. <ul style="list-style-type: none"> #1222 aux06 bit2 #1223 aux07 bit0 - Corrected the mistakes.
Feb. 2014	IB(NA)-1500908-F	<ul style="list-style-type: none"> - The title of this manual is changed to "M700BM/M700UM Series Alarm/Parameter Manual" - Corrected "Introduction". - Added "Trademarks". - Added "Handling of our product". <p>[Alarms]</p> <ul style="list-style-type: none"> - Added the items below. 1.1 Operation Errors <ul style="list-style-type: none"> M01_0023, M01_0034 to M01_0037, M01_0131 to M01_0151, M01_0154, M01_0203 1.2 Stop Codes <ul style="list-style-type: none"> T01_0119 1.3 Servo/Spindle Alarms <ul style="list-style-type: none"> S05, S53 1.4 MCP Alarms <ul style="list-style-type: none"> Y20_0013 to Y20_0014, Y20_0038 to Y20_0039, Y51_0018, Y51_0021 to Y51_0027 1.5 System Alarms <ul style="list-style-type: none"> Z20, Z87 to Z88 1.12 Program Errors <ul style="list-style-type: none"> P32 to P34, P169, P505 to P506, P540, P550 to P554, P610, P941, P958 to P972 - Corrected the items below. <ul style="list-style-type: none"> 1.1 Operation Errors <ul style="list-style-type: none"> M01_0005, M01_0051, M01_0057, M01_0204, M01_1003 to M01_1004, M01_1034 to M01_1035, M91_0002 1.2 Stop Codes <ul style="list-style-type: none"> T01_0116, T01_0193, T10 to T11 1.3 Servo/Spindle Alarms <ul style="list-style-type: none"> SV01_0019, PS01_0066, PS01_006B, PS01_006E, PS01_0074, PS01_0076, S52_00A3, S52_00E8-00EF, S52_00EF 1.4 MCP Alarms <ul style="list-style-type: none"> Y07 to Y09, Y20_0009, Y51_0014 to Y51_0016 <p>(Continue to the next page)</p>

Date of revision	Manual No.	Revision details
		<p>(Continued from the previous page)</p> <p>1.5 System Alarms Z35_0001 to Z35_0005, Z52, Z64 to Z65</p> <p>1.6 Absolute Position Detection System Alarms Z71_0001, Z73_0001</p> <p>1.10 User PLC Alarms U10_0x800x to U10_0x8Bxx</p> <p>1.12 Program Errors P49, P60, P111, P126, P170, P411, P485, P501 to P503, P520, P555, P602, P921 to P923</p> <p>- Deleted the items below. 1.1 Operation Errors M01_0166</p> <p>- Corrected the chapters below. 1.3.1 Servo Errors (S01/S03/S04) 1.3.5 Servo Warnings (S52)</p> <p>[Parameters]</p> <p>- Added the items below.</p> <p>2.1 Machining Parameters #8025 to #8028, #8030, #8071, #8077, #8083 to #8086, #8128, #8214, #8222 to #8223, #8876 to #8877, #19418</p> <p>2.3 Base Specifications Parameters #1000, #1043, #1225(bit5), #1233(bit4), #1234(bit4), #1248(bit0), #1252(bit1), #1253(bit3), #1257(bit0 to bit2), #1258(bit2), #1260(bit6), #1261(bit0), #1264(bit6 to bit7), #1268(bit4 to bit5,bit7), #1269(bit0 to bit1), #1274(bit2 to bit5), #1279(bit5 to bit7), #1281(bit2,bit5), #1282(bit3 to bit6), #1287(bit1 to bit2), #1289(bit1), #1291(bit1), #1292(bit0 to bit6), #1299(bit1), #1323, #1351 to #1352, #1379 to #1382, #1558 to #1560, #1575 to #1587, #1597, #1934 to #1942, #11005, #11040 to #11639, #12022 to #12047, #39351 to #39357+5n</p> <p>2.4 Axis Specifications Parameters #2100, #2178, #2185 to #2186, #2191 to #2197, #2580, #2592 to #2617, #12400 to #12550</p> <p>2.6 Spindle Parameters #3078, #3149 to #3191</p> <p>- Corrected the items below.</p> <p>2.1 Machining Parameters #8012, #8018, #8157, #8208, #8215, #8300 to #8306, #8311 to #8316, #8318 to #8319</p> <p>2.2 I/O Parameters #9019 to #9020</p> <p>2.3 Base Specifications Parameters #1004, #1037, #1050, #1095, #1154, #1205, #1210, #1223, #1238(bit7), #1273(bit0), #1280(bit0 to bit2), #1313 to #1314, #1369 to #1370, #1520, #1566</p> <p>2.4 Axis Specifications Parameters #2003(HEX-3), #2015 to #2016, #2027, #2029, #2036, #2049, #2057 to #2058, #2080 to #2081, #2097 to #2098, #2118, #2140 to #2142, #2146 to #2153, #2156, #2180, #2188</p> <p>2.5 Servo Parameters #2225</p> <p>2.6 Spindle Parameters #3001 to #3008, #3013 to #3022, #3024 to #3029, #3031, #3035, #3037 to #3051, #3054 to #3072, #3101 to #3118, #3120, #3122 to #3124, #3127 to #3132, #3137, #3140, #3145 to #3152</p> <p>2.7 Rotary Axis Configuration Parameters #7948</p> <p>2.10 Macro List #7001, #7011, #7021, #7031, #7041, #7051, #7061, #7071, #7081, #7091, #7201, #7211, #7221, #7231, #7241, #7251, #7261, #7271, #7281, #7291</p> <p>- Deleted the items below. 2.3 Base Specifications Parameters #1240/bit2</p> <p>- Corrected the chapters below. 2.5 Servo Parameters 2.6 Spindle Parameters 2.9 PLC Constants</p> <p>- Corrected the mistakes.</p>

Global Service Network

AMERICA

MITSUBISHI ELECTRIC AUTOMATION INC. (AMERICA FA CENTER)

Central Region Service Center
500 CORPORATE WOODS PARKWAY, VERNON HILLS, ILLINOIS 60061, U.S.A.
TEL: +1-847-478-2500 / FAX: +1-847-478-2650

Michigan Service Satellite
ALLEGAN, MICHIGAN 49010, U.S.A.
TEL: +1-847-478-2500 / FAX: +1-847-478-2650

Ohio Service Satellite
LIMA, OHIO 45901, U.S.A.
TEL: +1-847-478-2500 / FAX: +1-847-478-2650
CINCINNATI, OHIO 45201, U.S.A.
TEL: +1-847-478-2500 / FAX: +1-847-478-2650

Minnesota Service Satellite
ROGERS, MINNESOTA 55374, U.S.A.
TEL: +1-847-478-2500 / FAX: +1-847-478-2650

West Region Service Center
16900 VALLEY VIEW AVE., LAMIRADA, CALIFORNIA 90638, U.S.A.
TEL: +1-714-699-2625 / FAX: +1-847-478-2650

Northern CA Satellite
SARATOGA, CALIFORNIA 95070, U.S.A.
TEL: +1-714-699-2625 / FAX: +1-847-478-2650

Pennsylvania Service Satellite
PITTSBURG, PENNSYLVANIA 15644, U.S.A.
TEL: +1-732-560-4500 / FAX: +1-732-560-4531

Connecticut Service Satellite
TORRINGTON, CONNECTICUT 06790, U.S.A.
TEL: +1-732-560-4500 / FAX: +1-732-560-4531

South Region Service Center
1845 SATTELITE BOULEVARD STE. 450, DULUTH, GEORGIA 30097, U.S.A.
TEL: +1-678-258-4529 / FAX: +1-678-258-4519

Texas Service Satellites
GRAPEVINE, TEXAS 76051, U.S.A.
TEL: +1-678-258-4529 / FAX: +1-678-258-4519
HOUSTON, TEXAS 77001, U.S.A.
TEL: +1-678-258-4529 / FAX: +1-678-258-4519

Tennessee Service Satellite
Nashville, Tennessee, 37201, U.S.A.
TEL: +1-678-258-4529 / FAX: +1-678-258-4519

Florida Service Satellite
WEST MELBOURNE, FLORIDA 32904, U.S.A.
TEL: +1-678-258-4529 / FAX: +1-678-258-4519

Canada Region Service Center
4299 14TH AVENUE MARKHAM, ONTARIO L3R 0J2, CANADA
TEL: +1-905-475-7728 / FAX: +1-905-475-7935

Canada Service Satellite
EDMONTON, ALBERTA T5A 0A1, CANADA
TEL: +1-905-475-7728 / FAX: +1-905-475-7935

Mexico Region Service Center
MARIANO ESCOBEDO 69 TLALNEPANTLA, 54030 EDO. DE MEXICO
TEL: +52-55-3067-7500 / FAX: +52-55-9171-7649

Monterrey Service Satellite
MONTERREY, N.L., 64720, MEXICO
TEL: +52-81-8365-4171

BRAZIL

MELCO CNC do Brasil Comércio e Serviços S.A

Brazil Region Service Center
ACESSO JOSE SARTORELLI, KM 2.1 CEP 18550-000, BOITUVA-SP, BRAZIL
TEL: +55-15-3363-9900 / FAX: +55-15-3363-9911

EUROPE

MITSUBISHI ELECTRIC EUROPE B.V.

GOTHAER STRASSE 10, 40880 RATINGEN, GERMANY
TEL: +49-2102-486-0 / FAX: +49-2102-486-5910

Germany Service Center
KURZE STRASSE, 40, 70794 FILDERSTADT-BONLANDEN, GERMANY
TEL: +49-711-770598-123 / FAX: +49-711-770598-141

France Service Center DEPARTEMENT CONTROLE NUMERIQUE
25, BOULEVARD DES BOUVETS, 92741 NANTERRE CEDEX FRANCE
TEL: +33-1-41-02-83-13 / FAX: +33-1-49-01-07-25

France (Lyon) Service Satellite DEPARTEMENT CONTROLE NUMERIQUE
120, ALLEE JACQUES MONOD 69800 SAINT PRIEST FRANCE
TEL: +33-1-41-02-83-13 / FAX: +33-1-49-01-07-25

Italy Service Center
VIALE COLLEONI, 7 - CENTRO DIREZIONALE COLLEONI PALAZZO SIRIO INGRESSO 1
20864 AGRATE BRIANZA (MB), ITALY
TEL: +39-039-6053-342 / FAX: +39-039-6053-206

Italy (Padova) Service Satellite
VIA G. SAVELLI, 24 - 35129 PADOVA, ITALY
TEL: +39-039-6053-342 / FAX: +39-039-6053-206

U.K. Branch
TRAVELLERS LANE, HATFIELD, HERTFORDSHIRE, AL10 8XB, U.K.
TEL: +49-2102-486-0 / FAX: +49-2102-486-5910

Spain Service Center
CTRA. DE RUBI, 76-80-APDO. 420
08173 SAINT CUGAT DEL VALLES, BARCELONA SPAIN
TEL: +34-935-65-2236 / FAX: +34-935-65-1579

Poland Service Center
UL. KRAKOWSKA 50, 32-083 BALICE, POLAND
TEL: +48-12-630-4700 / FAX: +48-12-630-4701

Mitsubishi Electric Turkey A.Ş Ümraniye Şubesi
Turkey Service Center
ŞERİFALİ MAH. NUTUK SOK. NO.5 34775
ÜMRANIYE, İSTANBUL, TURKEY
TEL: +90-216-526-3990 / FAX: +90-216-526-3995

Czech Republic Service Center
KAFKOVA 1853/3, 702 00 OSTRAVA 2, CZECH REPUBLIC
TEL: +420-59-5691-185 / FAX: +420-59-5691-199

Russia Service Center
213, B.NOVOODMITROVSKAYA STR., 14/2, 127015 MOSCOW, RUSSIA
TEL: +7-495-748-0191 / FAX: +7-495-748-0192

MITSUBISHI ELECTRIC EUROPE B.V. (SCANDINAVIA)
Sweden Service Center
HAMMARBACKEN 14 191 49 SOLLENTUNA, SWEDEN
TEL: +46-8-6251000 / FAX: +46-8-966877

Bulgaria Service Center
4 A.LYAPCHEV BOUL., POB 21, BG-1756 SOFIA, BULGARIA
TEL: +359-2-8176009 / FAX: +359-2-9744061

Ukraine (Kharkov) Service Center
APTEKARSKIY LANE 9-A, OFFICE 3, 61001 KHARKOV, UKRAINE
TEL: +380-57-732-7774 / FAX: +380-57-731-8721

Ukraine (Kiev) Service Center
4-B, M. RASKOVOYI STR., 02660 KIEV, UKRAINE
TEL: +380-44-494-3355 / FAX: +380-44-494-3366

Belarus Service Center
OFFICE 9, NEZAVISIMOSTI PR.177, 220125 MINSK, BELARUS
TEL: +375-17-393-1177 / FAX: +375-17-393-0081

South Africa Service Center
5 ALBATROSS STREET, RHODESFIELD, KEMPTON PARK 1619, GAUTENG, SOUTH AFRICA
TEL: +27-11-394-8512 / FAX: +27-11-394-8513

ASEAN**MITSUBISHI ELECTRIC ASIA PTE. LTD. (ASEAN FA CENTER)**

Singapore Service Center
307 ALEXANDRA ROAD #05-01/02 MITSUBISHI ELECTRIC BUILDING SINGAPORE 159943
TEL: +65-6473-2308 / FAX: +65-6476-7439

Malaysia (KL) Service Center
60, JALAN USJ 10/1B 47620 UEP SUBANG JAYA SELANGOR DARUL EHSAN, MALAYSIA
TEL: +60-3-5631-7605 / FAX: +60-3-5631-7636

Malaysia (Johor Baru) Service Center
17 & 17A, JALAN IMPIAN EMAS 5/5, TAMAN IMPIAN EMAS, 81300 SKUDAI, JOHOR MALAYSIA.
TEL: +60-7-557-8218 / FAX: +60-7-557-3404

Philippines Service Center
UNIT NO.411, ALABANG CORPORATE CENTER KM 25, WEST SERVICE ROAD
SOUTH SUPERHIGHWAY, ALABANG MUNTINLUPA METRO MANILA, PHILIPPINES 1771
TEL: +63-2-807-2416 / FAX: +63-2-807-2417

VIETNAM**MITSUBISHI ELECTRIC VIETNAM CO.,LTD**

Vietnam (Ho Chi Minh) Service Center
UNIT 01-04, 10TH FLOOR, VINCOM CENTER 72 LE THANH TON STREET, DISTRICT 1,
HO CHI MINH CITY, VIETNAM
TEL: +84-8-3910 5945 / FAX: +84-8-3910 5946

Vietnam (Hanoi) Service Satellite
SUITE 9-05, 9TH FLOOR, HANOI CENTRAL OFFICE BUILDING, 44B LY THUONG KIET STREET,
HOAN KIEM DISTRICT, HANOI CITY, VIETNAM
TEL: +84-4-3937-8075 / FAX: +84-4-3937-8076

INDONESIA**PT. MITSUBISHI ELECTRIC INDONESIA**

Indonesia Service Center
GEDUNG JAYA 11TH FLOOR, JL. MH. THAMRIN NO.12, JAKARTA PUSAT 10340, INDONESIA
TEL: +62-21-3192-6461 / FAX: +62-21-3192-3942

THAILAND**MITSUBISHI ELECTRIC FACTORY AUTOMATION (THAILAND) CO.,LTD**

Thailand Service Center
12TH FLOOR, SV.CITY BUILDING, OFFICE TOWER 1, NO. 896/19 AND 20 RAMA 3 ROAD,
KWAENG BANGPONGPANG, KHET YANNAWA, BANGKOK 10120,THAILAND
TEL: +66-2-682-6522-31 / FAX: +66-2-682-6020

INDIA**MITSUBISHI ELECTRIC INDIA PVT. LTD.**

India Service Center
2nd FLOOR, TOWER A & B, DLF CYBER GREENS, DLF CYBER CITY,
DLF PHASE-III, GURGAON 122 002, HARYANA, INDIA
TEL: +91-124-4630 300 / FAX: +91-124-4630 399

Ludhiana satellite office
Jamshedpur satellite office

India (Pune) Service Center
EMERALD HOUSE, EL-3, J-BLOCK, MIDC BHOSARI, PUNE – 411 026, MAHARASHTRA, INDIA
TEL: +91-20-2710 2000 / FAX: +91-20-2710 2100

Baroda satellite office
Mumbai satellite office

India (Bangalore) Service Center
PRESTIGE EMERALD, 6TH FLOOR, MUNICIPAL NO. 2,
LAVELLE ROAD, BANGALORE - 560 043, KAMATAKA, INDIA
TEL: +91-80-4020-1600 / FAX: +91-80-4020-1699

Chennai satellite office
Coimbatore satellite office

OCEANIA**MITSUBISHI ELECTRIC AUSTRALIA LTD.**

Australia Service Center
348 VICTORIA ROAD, RYDALMERE, N.S.W. 2116 AUSTRALIA
TEL: +61-2-9684-7269 / FAX: +61-2-9684-7245

CHINA**MITSUBISHI ELECTRIC AUTOMATION (CHINA) LTD. (CHINA FA CENTER)**

China (Shanghai) Service Center
1-3.5-10,18-23/F, NO.1386 HONG QIAO ROAD, CHANG NING QU,
SHANGHAI 200336, CHINA
TEL: +86-21-2322-3030 / FAX: +86-21-2308-3000

China (Ningbo) Service Dealer
China (Wuxi) Service Dealer
China (Jinan) Service Dealer
China (Hangzhou) Service Dealer
China (Wuhan) Service Satellite

China (Beijing) Service Center
9/F, OFFICE TOWER 1, HENDERSON CENTER, 18 JIANGUOMENNEI DAJIE,
DONGCHENG DISTRICT, BEIJING 100005, CHINA
TEL: +86-10-6518-8830 / FAX: +86-10-6518-8030

China (Beijing) Service Dealer

China (Tianjin) Service Center
UNIT 2003, TIANJIN CITY TOWER, NO 35 YOUYI ROAD, HEXI DISTRICT,
TIANJIN 300061, CHINA
TEL: +86-22-2813-1015 / FAX: +86-22-2813-1017

China (Shenyang) Service Satellite
China (Changchun) Service Satellite

China (Chengdu) Service Center
ROOM 407-408, OFFICE TOWER AT SHANGRI-LA CENTER, NO. 9 BINJIANG DONG ROAD,
JINJIANG DISTRICT, CHENGDU, SICHUAN 610021, CHINA
TEL: +86-28-8446-8030 / FAX: +86-28-8446-8630

China (Shenzhen) Service Center
ROOM 2512-2516, 25/F., GREAT CHINA INTERNATIONAL EXCHANGE SQUARE, JINTIAN RD.S.,
FUTIAN DISTRICT, SHENZHEN 518034, CHINA
TEL: +86-755-2399-8272 / FAX: +86-755-8218-4776

China (Xiamen) Service Dealer
China (Dongguan) Service Dealer

KOREA**MITSUBISHI ELECTRIC AUTOMATION KOREA CO., LTD. (KOREA FA CENTER)**

Korea Service Center
1480-6, GAYANG-DONG, GANGSEO-GU, SEOUL 157-200, KOREA
TEL: +82-2-3660-9602 / FAX: +82-2-3664-8668

Korea Taegu Service Satellite
4F KT BUILDING, 1630 SANGYEOK-DONG, BUK-KU, DAEGU 702-835, KOREA
TEL: +82-53-382-7400 / FAX: +82-53-382-7411

TAIWAN**MITSUBISHI ELECTRIC TAIWAN CO., LTD. (TAIWAN FA CENTER)**

Taiwan (Taichung) Service Center (Central Area)
NO.8-1, INDUSTRIAL 16TH RD., TAICHUNG INDUSTRIAL PARK, SITUN DIST.,
TAICHUNG CITY 40768, TAIWAN R.O.C.
TEL: +886-4-2359-0688 / FAX: +886-4-2359-0689

Taiwan (Taipei) Service Center (North Area)
10F, NO.88, SEC.6, CHUNG-SHAN N. RD., SHI LIN DIST., TAIPEI CITY 11155, TAIWAN R.O.C.
TEL: +886-2-2833-5430 / FAX: +886-2-2833-5433

Taiwan (Tainan) Service Center (South Area)
11F-1., NO.30, ZHONGZHENG S. ROAD, YONGKANG DISTRICT, TAINAN CITY 71067, TAIWAN, R.O.C
TEL: +886-6-252-5030 / FAX: +886-6-252-5031

Notice

Every effort has been made to keep up with software and hardware revisions in the contents described in this manual. However, please understand that in some unavoidable cases simultaneous revision is not possible. Please contact your Mitsubishi Electric dealer with any questions or comments regarding the use of this product.

Duplication Prohibited

This manual may not be reproduced in any form, in part or in whole, without written permission from Mitsubishi Electric Corporation.

COPYRIGHT 2008-2014 MITSUBISHI ELECTRIC CORPORATION
ALL RIGHTS RESERVED

MITSUBISHI CNC



MODEL	M700BM/M700UM Series
MODEL CODE	100-190
Manual No.	IB-1500908